

# Biobaler

Electric Diagram / Diagramme Électrique

To navigate the electric diagram, you can click on the **red rectangle** that identify the wiring section you want to look up, click on the



button to go back to the main section.

Pour naviguer dans le schéma électrique, vous pouvez cliquer sur les **rectangles rouges** qui identifie la section du câblage que vous souhaitez regarder, cliquez sur le bouton



pour revenir à la section principale.

# DIAGRAMME ÉLECTRIQUE/ELECTRIC DIAGRAM – BIOBALER

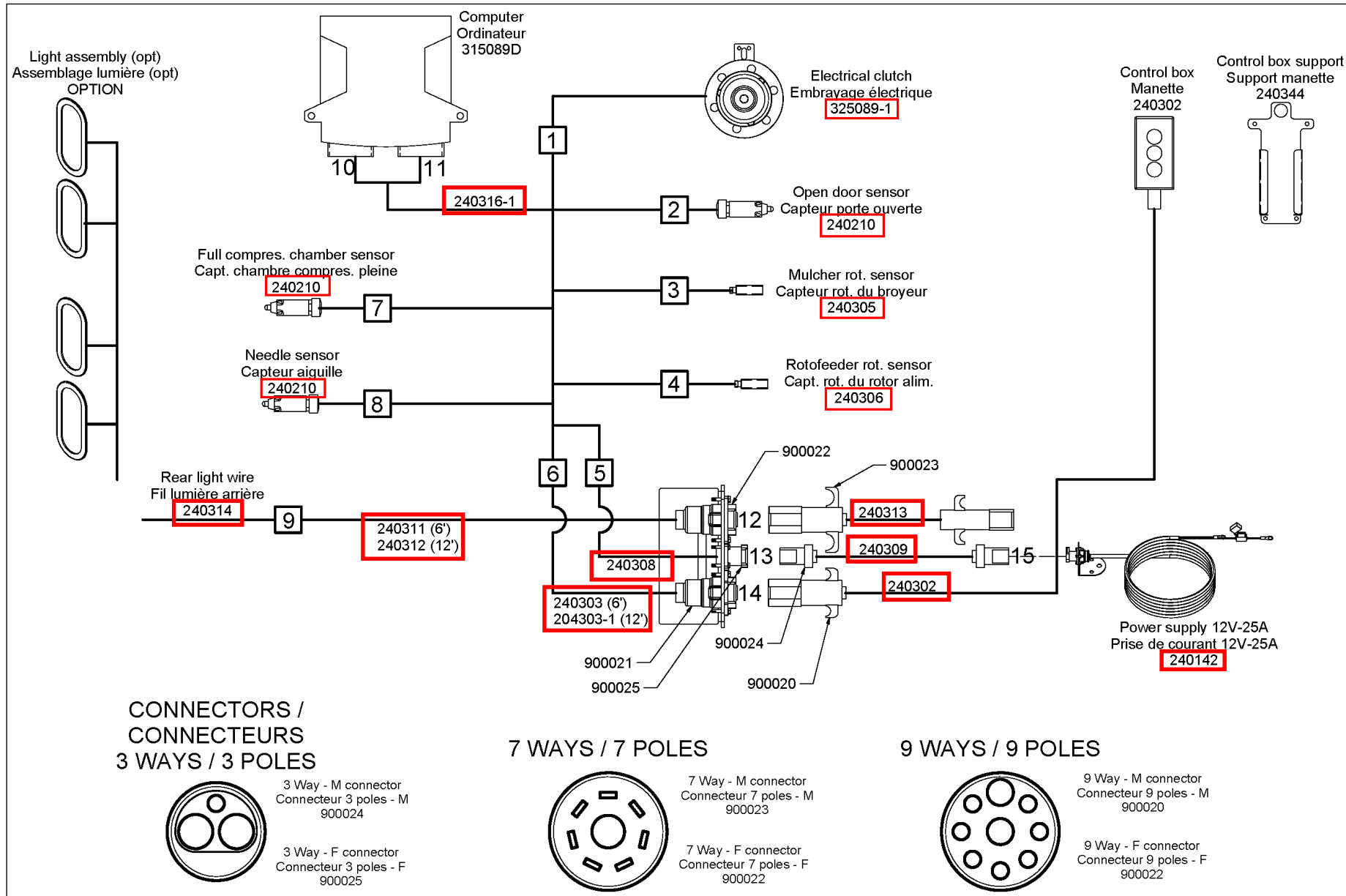

## CONNECTORS / CONNECTEURS 3 WAYS / 3 POLES

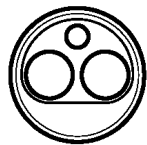

3 Way - M connector  
Connecteur 3 poles - M  
900024

3 Way - F connector  
Connecteur 3 poles - F  
900025

## 7 WAYS / 7 POLES

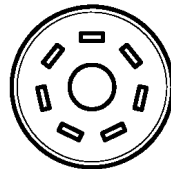

7 Way - M connector  
Connecteur 7 poles - M  
900023

7 Way - F connector  
Connecteur 7 poles - F  
900022

## 9 WAYS / 9 POLES

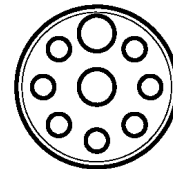

9 Way - M connector  
Connecteur 9 poles - M  
900020

9 Way - F connector  
Connecteur 9 poles - F  
900022



240142

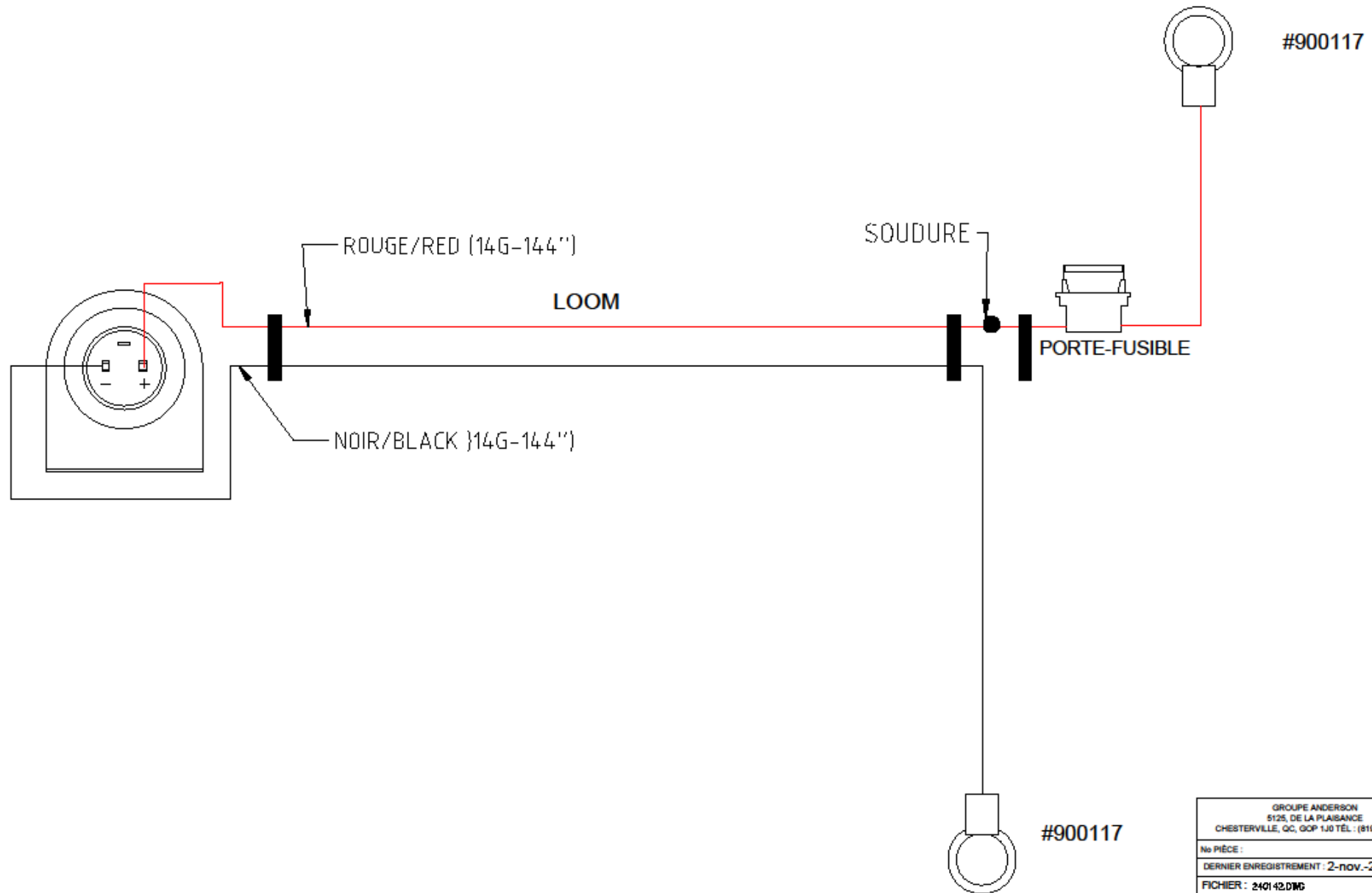

GRUPE ANDERSON 5125, DE LA PLAISANCE CHESTERVILLE, QC, G0P 1J0 TEL : (819) 382-2952
No PIÈCE :
DERNIER ENREGISTREMENT : 2-nov.-20
FICHER : 240142.DWG

240210

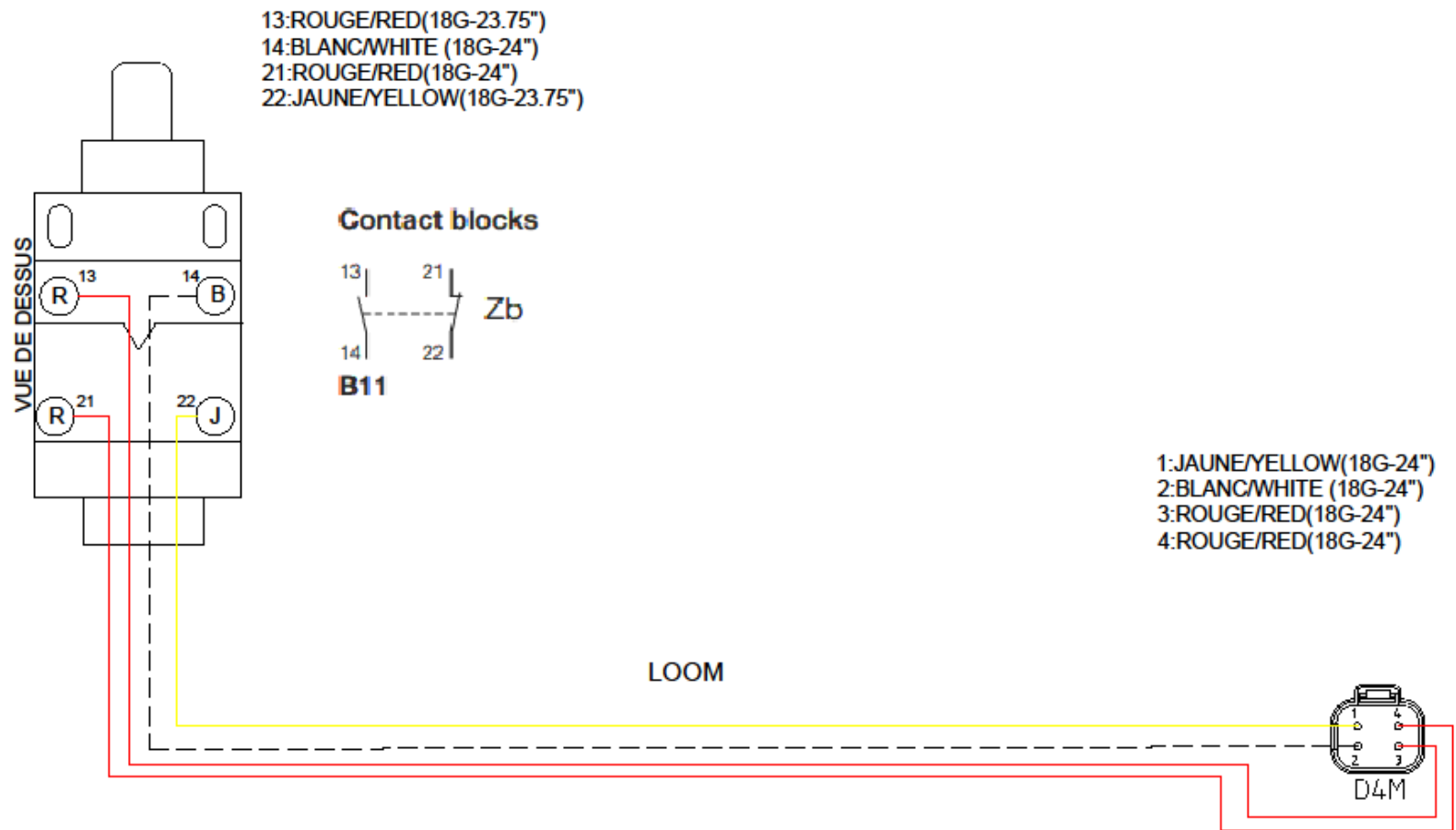

GRUPE ANDERSON 5125, DE LA PLAISANCE CHESTERVILLE, QC, G0P 1J0 TEL : (819) 382-2952
No PIÈCE :
DERNIER ENREGISTREMENT : 29-oct.-20
FICHER : 240210.DWG

240302

#14

CONNECTEUR VUE DE DOS  
900020

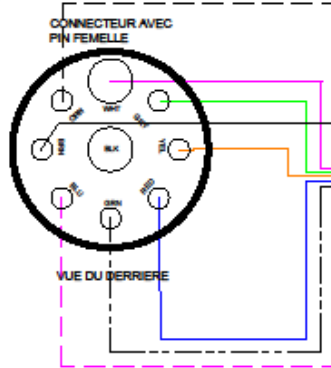

- WHT: ROSE/PINK
- GRY : VERT/GREEN
- YEL: ORANGE/ORANGE
- RED: BLEU/BLUE
- GRN: BLANC LIGNÉ / WHITE WITH LINE
- BLU: ROSE LIGNÉ/PINK WITH ILNE
- BRN: NOIR/BLACK
- ORN: BLANC/WHITE

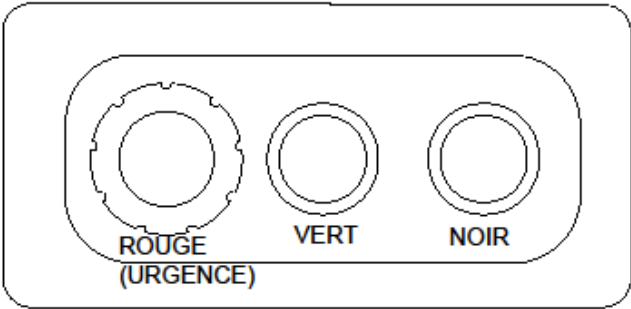
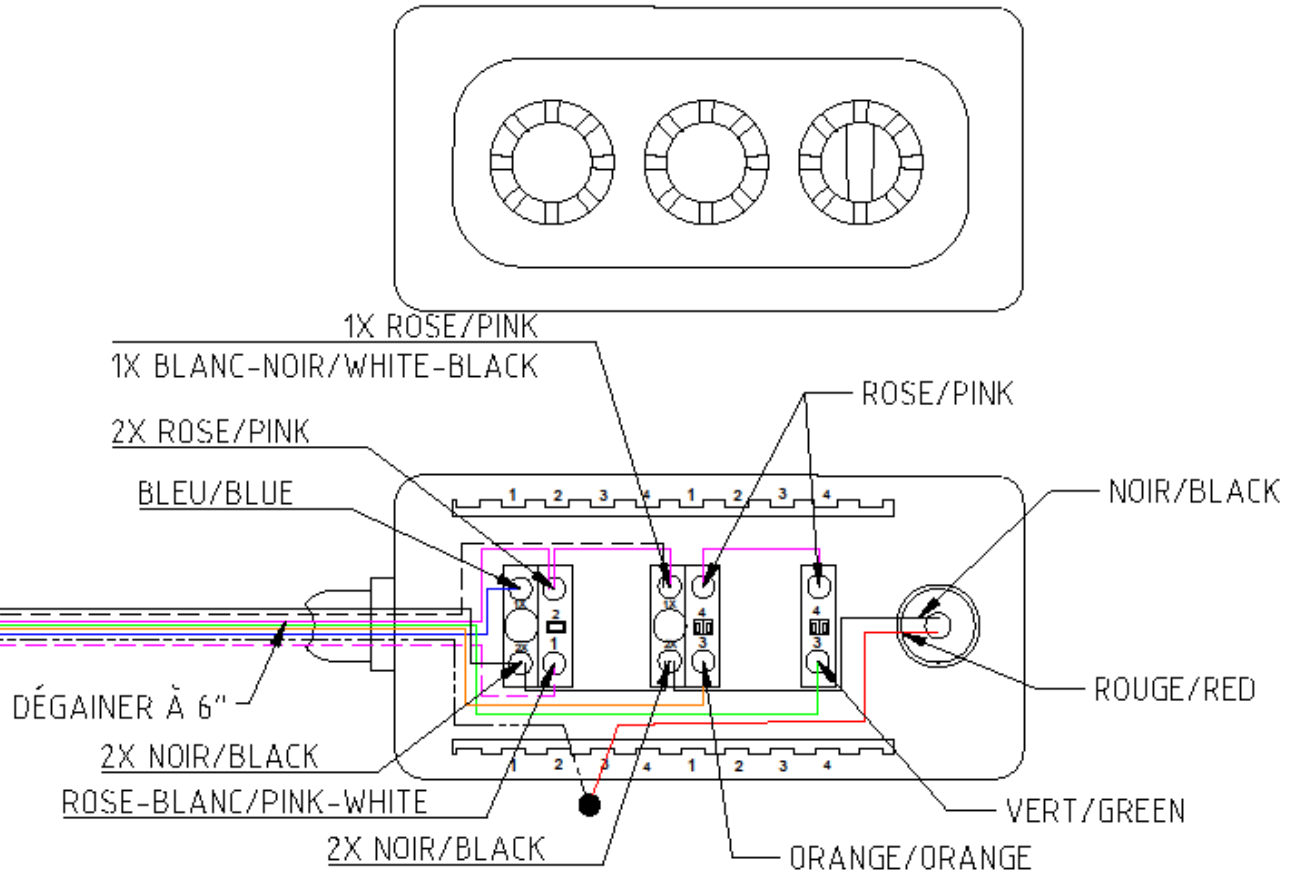

GROUPE ANDERSON 5125, DE LA PLAISANCE CHESTERVILLE, QC, G0P 1J0 TÉL. : (819) 382-2052
No PIÈCE :
DERNIER ENREGISTREMENT : 21-sept-20
FICHER : 240302.DWG

240303



- 1:ROSE/PINK(16')
- 2:ROSE-BLANC/PINK-WHITE (16')
- 3:VERT/GREEN (16')
- 4:ORANGE/ORANGE (16')
- 5:BLANC/WHITE (16')
- 6:BLANC-NOIR/WHITE-BLACK (16')
- 7:BLEU/BLUE (16')
- 8:NOIR/BLACK (16')

#6

CABLE 8 BRINS 16 PIEDS

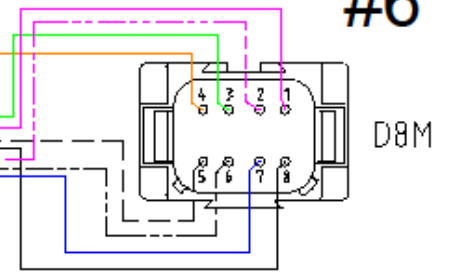
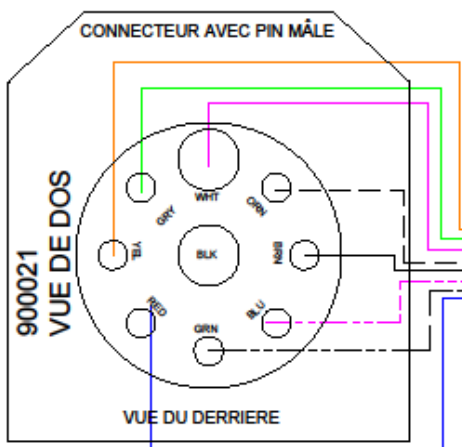

#14

- WHT: ROSE/PINK
- GRY : VERT/GREEN
- YEL: ORANGE/ORANGE
- RED: BLEU/BLUE
- GRN: BLANC LIGNÉ / WHITE WITH LINE
- BLU: ROSE LIGNÉ/PINK WITH ILNE
- BRN: NOIR/BLACK
- ORN: BLANC/WHITE

GRUPE ANDERSON 5125, DE LA PLAISANCE CHESTERVILLE, QC, GOP 1J0 TEL : (819) 382-2952
No PIÈCE :
DERNIER ENREGISTREMENT : 12-mai-20
FICHER : 240303.DWG

240305

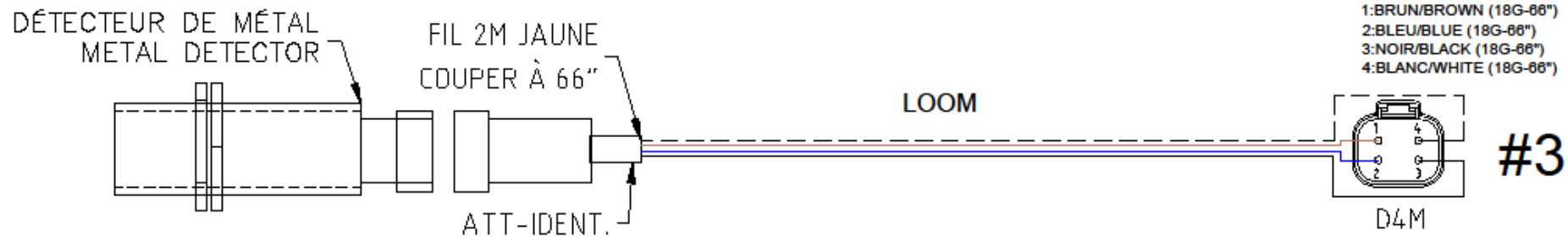

GRUPE ANDERSON 5125, DE LA PLAISANCE CHESTERVILLE, QC, G0P 1J0 TÉL. : (819) 382-2952
No PIÈCE :
DERNIER ENREGISTREMENT : 2-mars-22
FICHER : 240305.DWG

240306

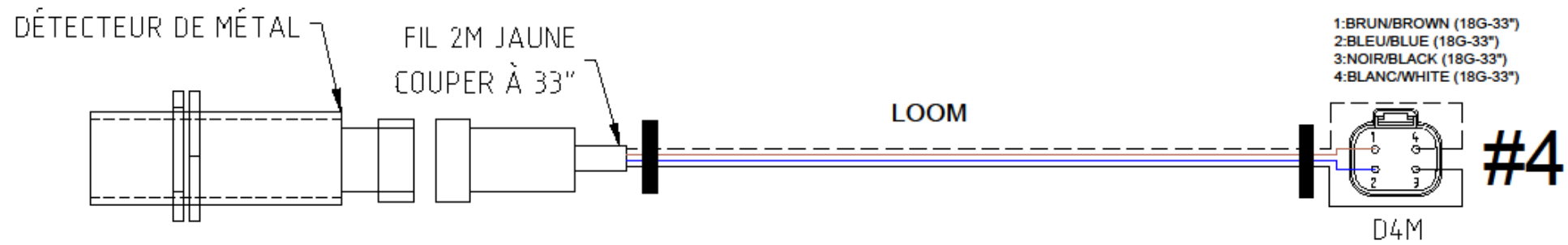



240308

+:ROUGE-RED(14G-258")  
-:NOIR-BLACK(14G-258")

#13

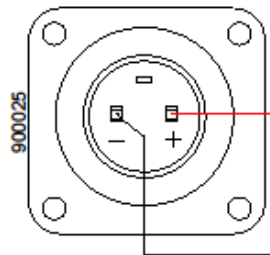

LOOM



1:ROUGE-RED(14G-258")  
2:NOIR-BLACK(14G-258")

#5

GRUPE ANDERSON 5125, DE LA PLAISANCE CHESTERVILLE, QC, G0P 1J0 TÉL : (819) 382-2952
No PIÈCE :
DERNIER ENREGISTREMENT : 12-mai-20
FICHER : 240308.DWG

240309



N.B: METTRE UNE TYRAP EN AVANT DU CAHOUTCHOU AVANT DE LE FERMER

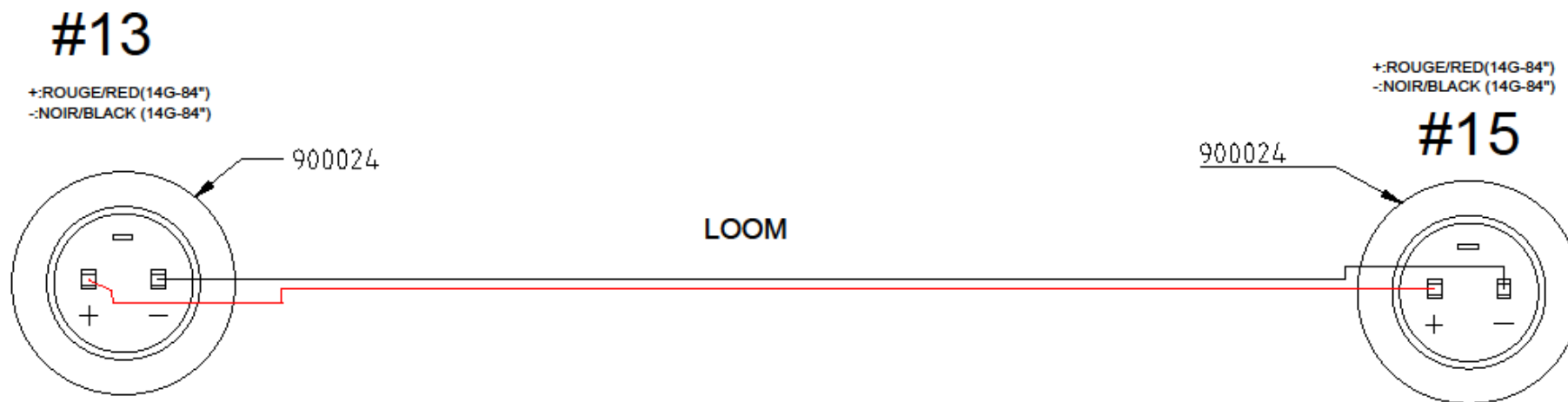

GRUPE ANDERSON 5125, DE LA PLAISANCE CHESTERVILLE, QC, QCP 1J0 TEL : (819) 382-2952
No PIÈCE :
DERNIER ENREGISTREMENT : 12-mai-20
FICHER : 240308.DWG

240312



# #12

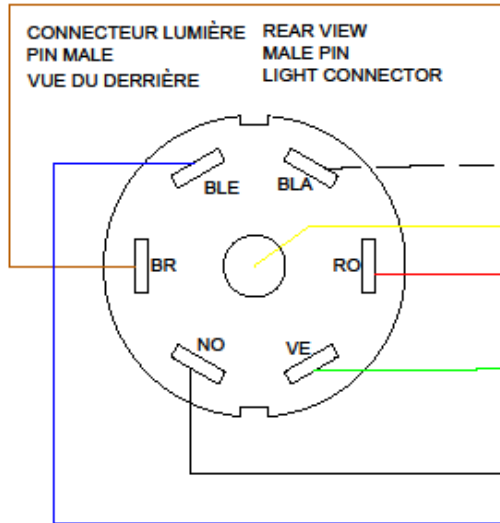

FIL LUMIÈRE 7 BRINS X 22 PIEDS

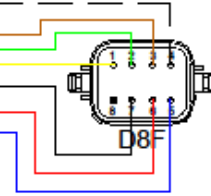

# #9

- 1: JAUNE/YELLOW (14G-22')
- 2: VERT/GREEN (14G-22')
- 3: BRUN/BROWN (14G-22')
- 4: BLANC/WHITE (14G-22')
- 5: BLEU/BLUE (14G-22')
- 6: ROUGE/RED (14G-22')
- 7: NOIR/BLACK (14G-22')
- 8: BOUCHON/PLUG

COULEURS DU FIL SELON LA COULEUR SUR CONNECTEUR - JAUNE AU CENTRE

COLOR AS WRITTEN ON THE CONNECTOR AND WITH THE WIRE COLOR. YELLOW IN THE CENTER

GRUPE ANDERSON 5125, DE LA PLAISANCE CHESTERVILLE, QC, G0P 1J0 TÉL : (819) 382-2052
No PIÈCE :
DERNIER ENREGISTREMENT : 2-mars-22
FICHER : 240312.DWG

240313



FIL 7 CONDUCTEURS NOIR : 84"

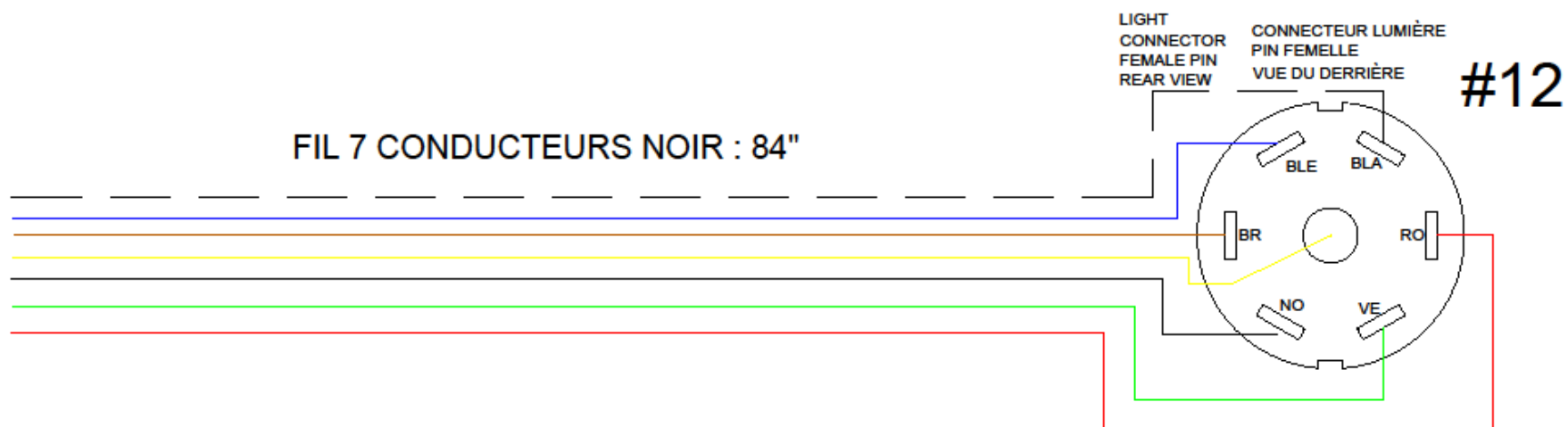

LIGHT  
CONNECTOR  
FEMALE PIN  
REAR VIEW

CONNECTEUR LUMIÈRE  
PIN FEMELLE  
VUE DU DERRIÈRE

#12

COULEURS DU FIL  
SELON LA COULEUR  
SUR CONNECTEUR  
- JAUNE AU CENTRE

COLOR AS WRITTEN ON  
THE CONNECTOR AND  
WITH THE WIRE COLOR.  
YELLOW IN THE CENTER

GRUPE ANDERSON 5125, DE LA PLAISANCE CHESTERVILLE, QC, G0P 1J0 TÉL : (819) 382-2952
N° PIÈCE :
DERNIER ENREGISTREMENT : 2-mars-22
FICHER : 240313.0102

240314



- 1:JAUNE/YELLOW (14G-12")
- 2:VERT/GREEN (14G-12")
- 3:BRUN/BROWN (14G-12")
- 4:BLANC/WHITE (14G-12")
- 5:BLEU/BLUE (14G-12")
- 6:ROUGE/RED (14G-12")
- 7:NOIR/BLACK (14G-12")
- 8:BOUCHON/PLUG

#9

FIL 7 CONDUCTEUR

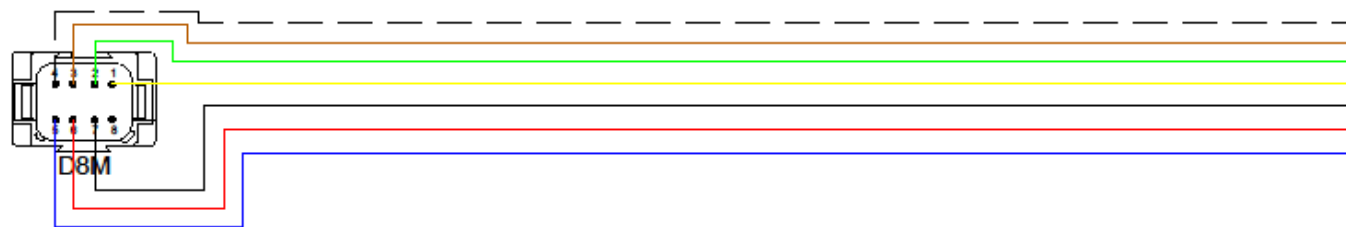

GRUPE ANDERSON 5125, DE LA PLAISANCE CHESTERVILLE, QC, G0P 1J0 TÉL. : (819) 383-2052
No PIÈCE :
DERNIER ENREGISTREMENT : 12-mai-20
FICHER : 240314.DWG

# 240316-1

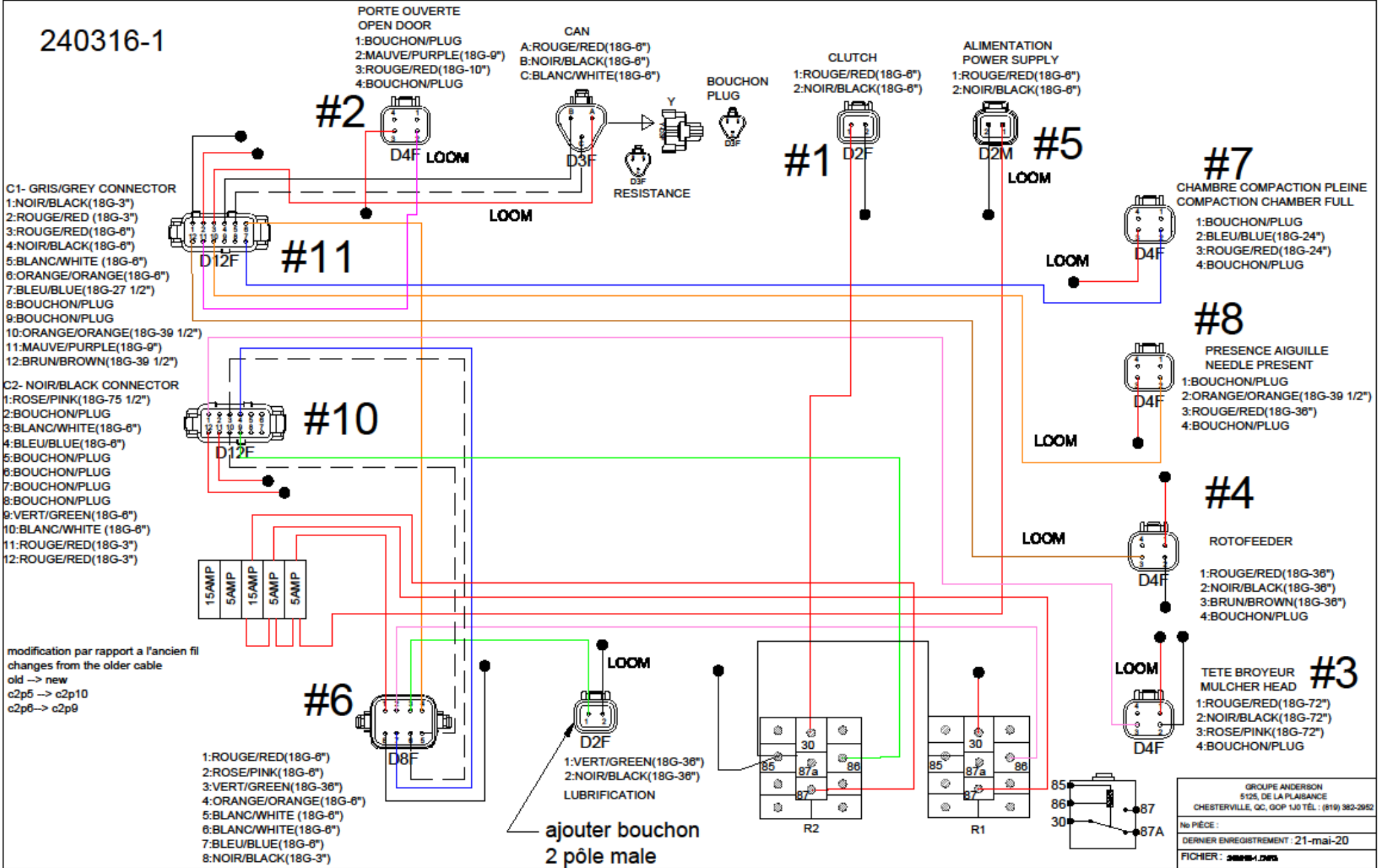

325089-1

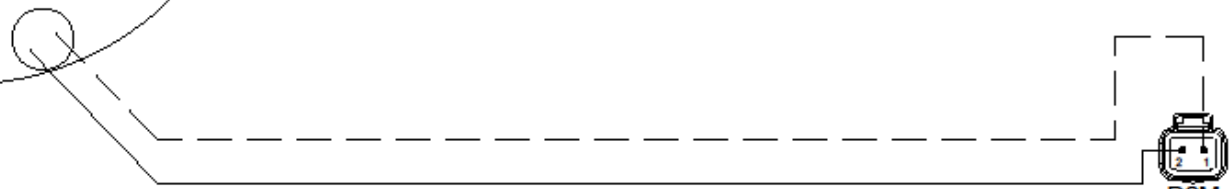
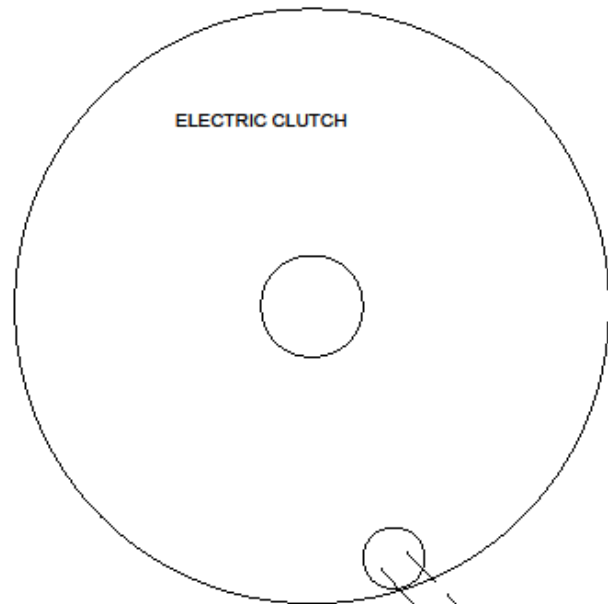

LOOM

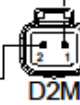

1:BLANC/WHITE (14G-18")  
2:NOIR/BLACK (14G-18")

#1

GRUPE ANDERSON 5125, DE LA PLAISANCE CHESTERVILLE, QC, G0P 1J0 TEL : (514) 382-2652
No PIÈCE :
DERNIER ENREGISTREMENT : 12-mai-20
FICHER : 325089-1.0WG