

Biobaler

Electric Diagram / Diagramme Électrique

To navigate the electric diagram, you can click on the **red rectangle** that identify the wiring section you want to look up, click on the

Back

button to go back to the main section.

Pour naviguer dans le schéma électrique, vous pouvez cliquer sur les **rectangles rouges** qui identifie la section du câblage que vous souhaitez regarder, cliquez sur le bouton

Back

pour revenir à la section principale.

DIAGRAMME ÉLECTRIQUE/ELECTRIC DIAGRAM – BIOBALER

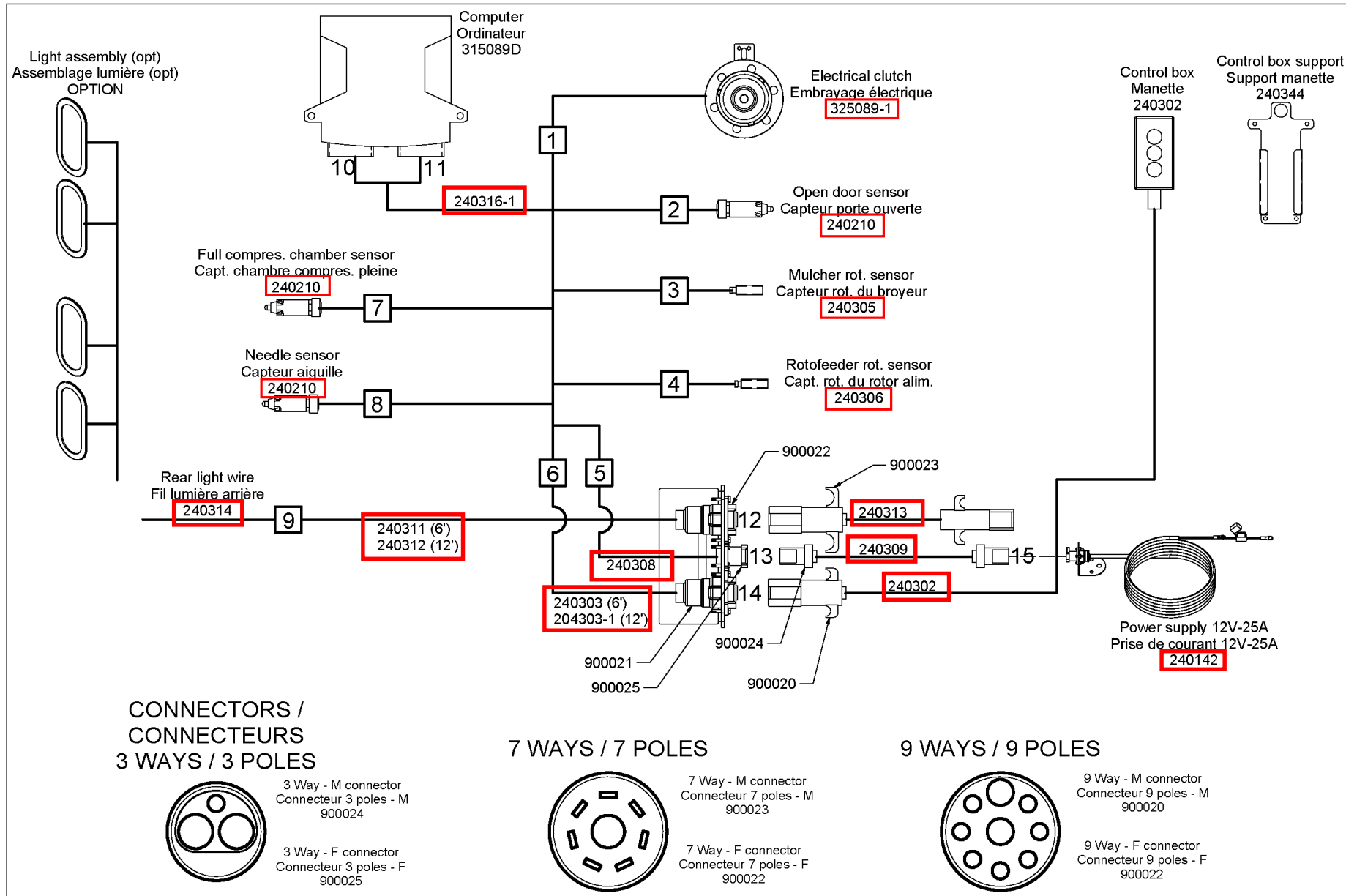

240142

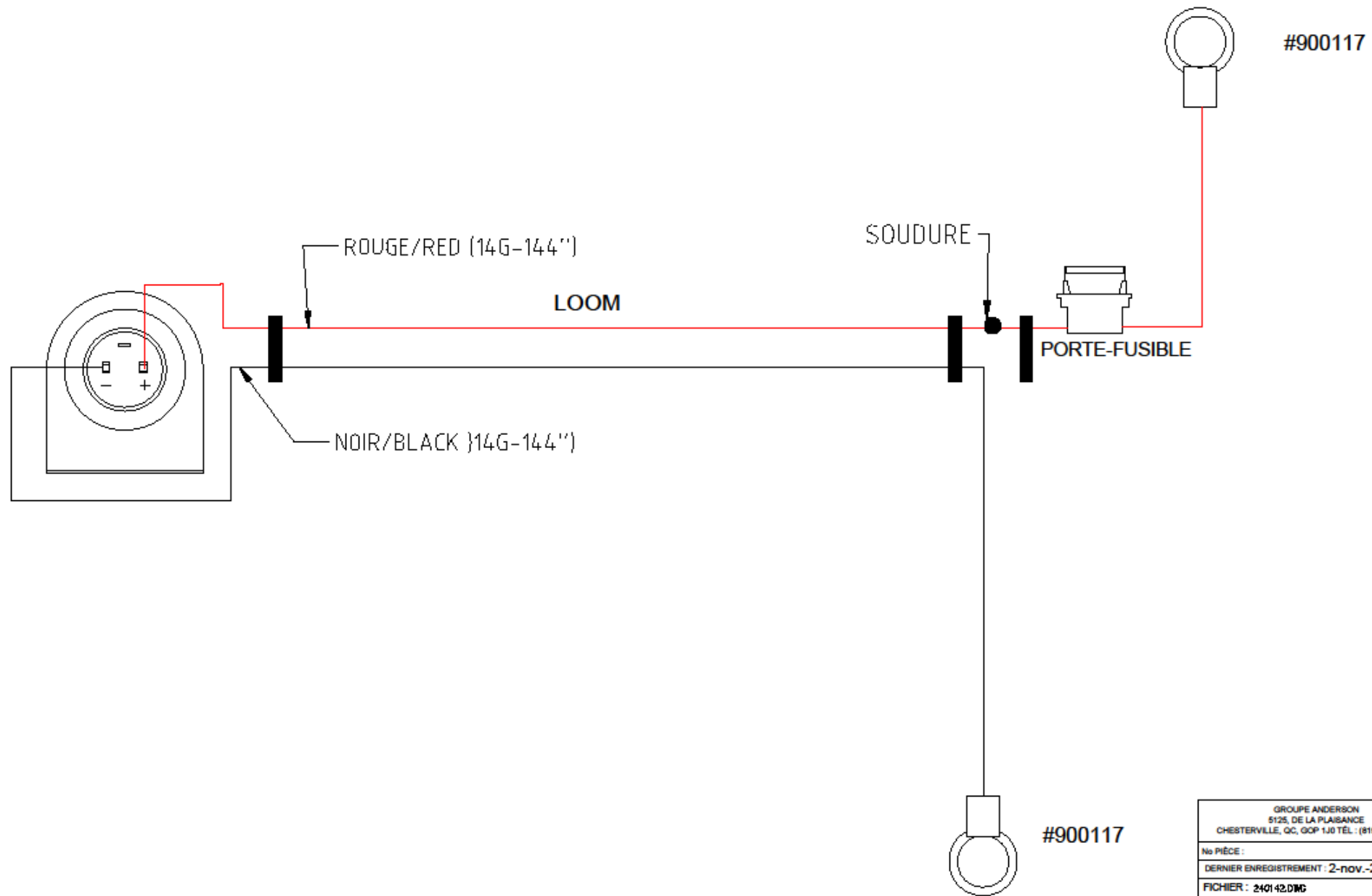

GRUPE ANDERSON 5125, DE LA PLAISANCE CHESTERVILLE, QC, G0P 1J0 TEL : (819) 382-2952
No PIÈCE :
DERNIER ENREGISTREMENT : 2-nov.-20
FICHER : 240142.DWG

240210

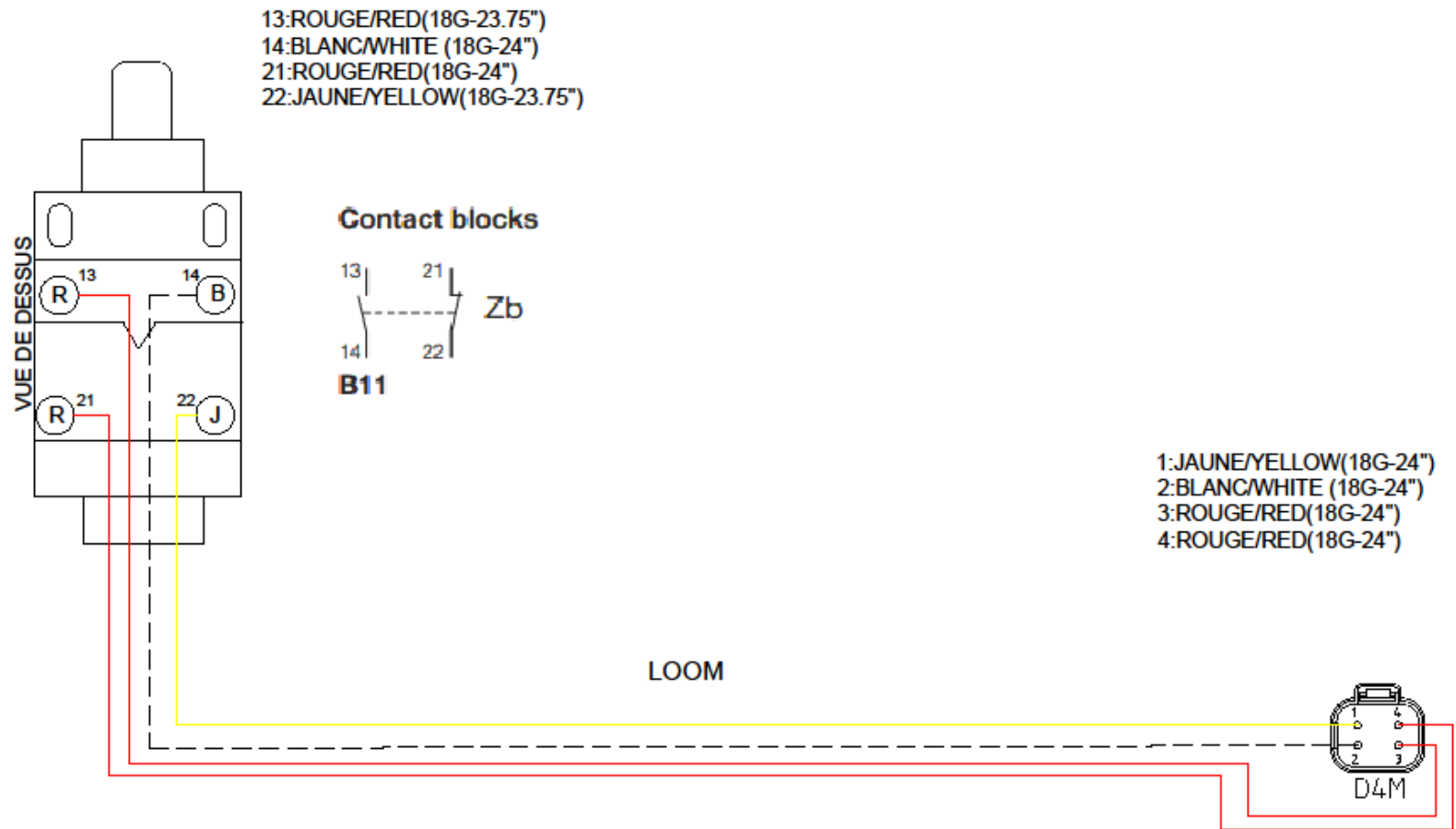

GRUPE ANDERSON 5125, DE LA PLAISANCE CHESTERVILLE, QC, G0P 1J0 TEL : (819) 382-2952
No PIÈCE :
DERNIER ENREGISTREMENT : 29-oct.-20
FICHER : 240210.DWG

240302

#14

CONNECTEUR VUE DE DOS
900020

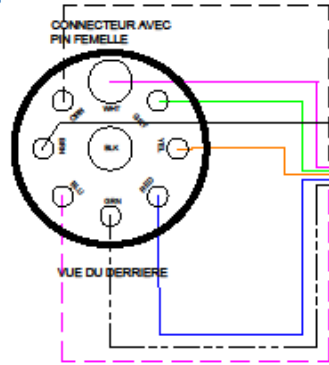

- WHT: ROSE/PINK
- GRY : VERT/GREEN
- YEL: ORANGE/ORANGE
- RED: BLEU/BLEU
- GRN: BLANC LIGNÉ / WHITE WITH LINE
- BLU: ROSE LIGNÉ/PINK WITH ILNE
- BRN: NOIR/BLACK
- ORN: BLANC/WHITE

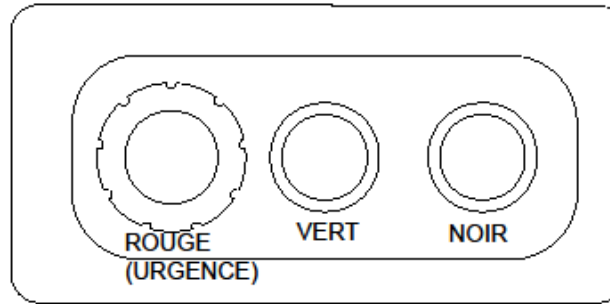
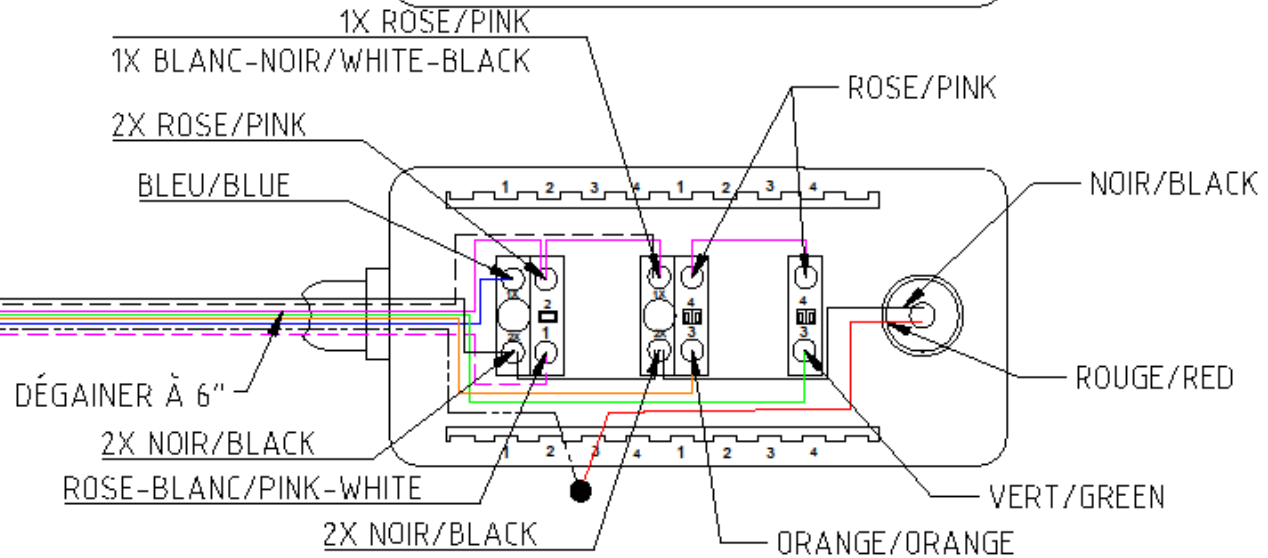

GROUPE ANDERSON 5125, DE LA PLAISANCE CHESTERVILLE, QC, G0P 1J0 TÉL : (819) 382-2452
No PIÈCE :
DERNIER ENREGISTREMENT : 21-sept-20
FICHER : 240302.DWG

240303

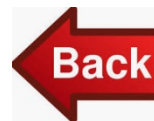

- 1:ROSE/PINK(16')
- 2:ROSE-BLANC/PINK-WHITE (16')
- 3:VERT/GREEN (16')
- 4:ORANGE/ORANGE (16')
- 5:BLANC/WHITE (16')
- 6:BLANC-NOIR/WHITE-BLACK (16')
- 7:BLEU/BLUE (16')
- 8:NOIR/BLACK (16')

#6

CABLE 8 BRINS 16 PIEDS

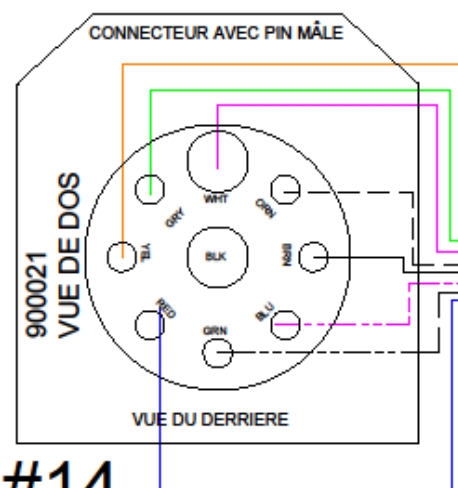

#14

- WHT: ROSE/PINK
- GRY : VERT/GREEN
- YEL: ORANGE/ORANGE
- RED: BLEU/BLUE
- GRN: BLANC LIGNÉ / WHITE WITH LINE
- BLU: ROSE LIGNÉ/PINK WITH ILNE
- BRN: NOIR/BLACK
- ORN: BLANC/WHITE

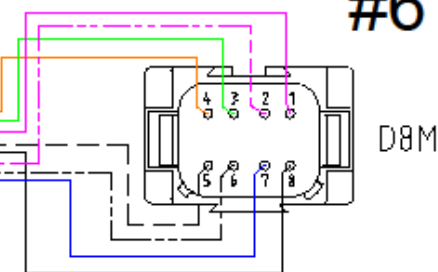

GRUPE ANDERSON 5125, DE LA PLAISANCE CHESTERVILLE, QC, GOP 1J0 TÉL : (819) 382-2952
N° PIÈCE :
DERNIER ENREGISTREMENT : 12-mai-20
FICHER : 240303.DWG

240305

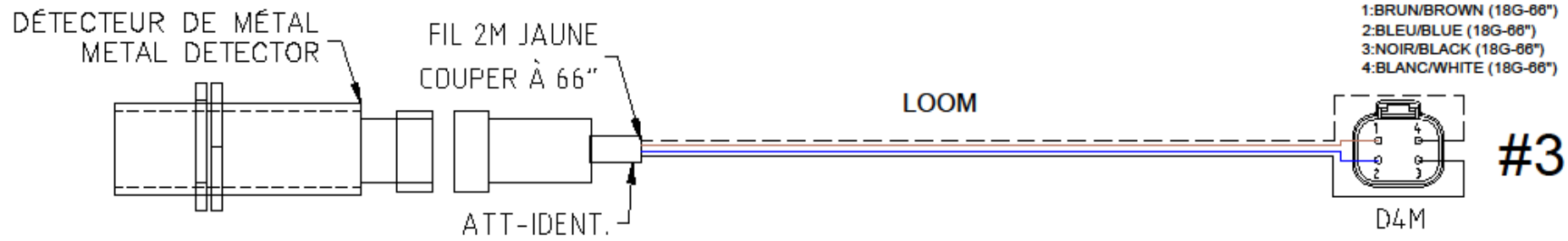

GRUPE ANDERSON 5125, DE LA PLAISANCE CHESTERVILLE, QC, G0P 1J0 TÉL. : (819) 382-2952
No PIÈCE :
DERNIER ENREGISTREMENT : 2-mars-22
FICHER : 240305.DWG

240306

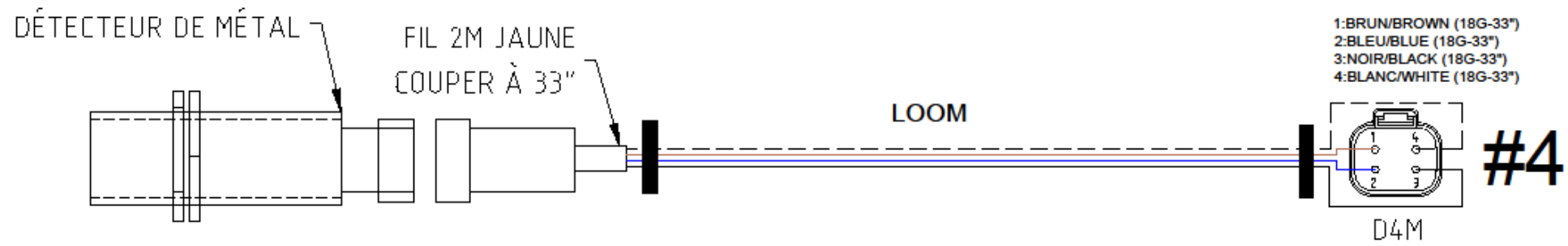

GRUPE ANDERSON 5125, DE LA PLAISANCE CHESTERVILLE, QC, G0P 1J0 TÉL : (819) 382-2952
No PIÈCE :
DERNIER ENREGISTREMENT : 25-juin-20
FICHIER : 240306.DWG

240308

+:ROUGE-RED(14G-258")
-:NOIR-BLACK(14G-258")

#13

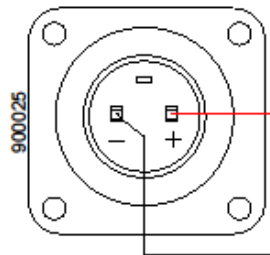

LOOM



1:ROUGE-RED(14G-258")
2:NOIR-BLACK(14G-258")

#5

GRUPE ANDERSON 5125, DE LA PLAISANCE CHESTERVILLE, QC, G0P 1J0 T�L : (819) 382-2952
No PI�CE :
DERNIER ENREGISTREMENT : 12-mai-20
FICHER : 240308.DWG

240309



N.B: METTRE UNE TYRAP EN AVANT DU CAHOUTCHOU AVANT DE LE FERMER

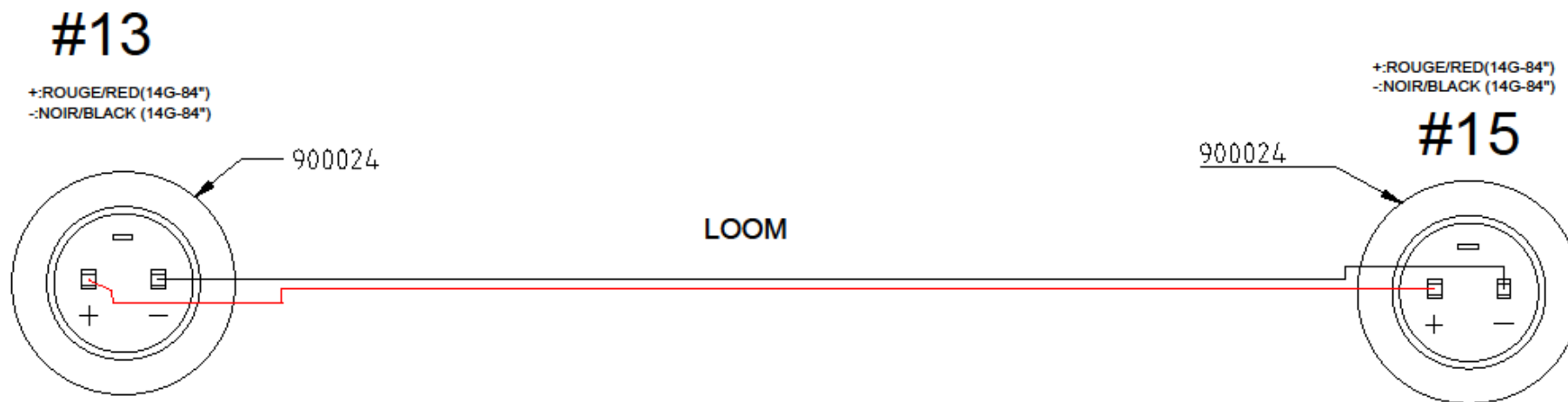

GRUPE ANDERSON 5125, DE LA PLAISANCE CHESTERVILLE, QC, QCP 1J0 TEL : (819) 382-2952
No PIÈCE :
DERNIER ENREGISTREMENT : 12-mai-20
FICHER : 240308.DWG

240312



#12

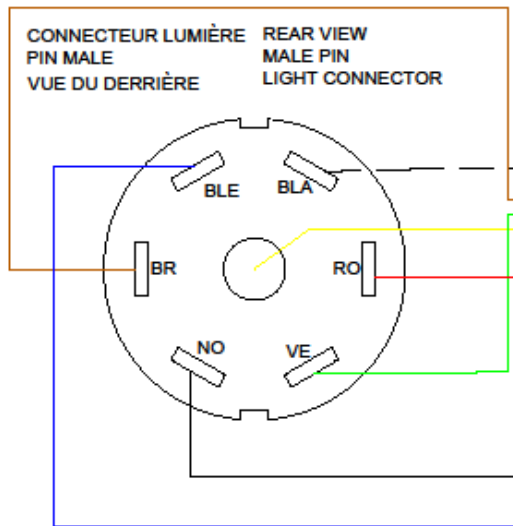

CONNECTEUR LUMIÈRE
PIN MALE
VUE DU DERRIÈRE

REAR VIEW
MALE PIN
LIGHT CONNECTOR

FIL LUMIÈRE 7 BRINS X 22 PIEDS

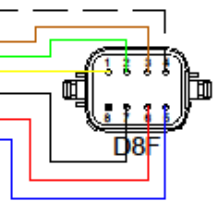

#9

- 1: JAUNE/YELLOW (14G-22')
- 2: VERT/GREEN (14G-22')
- 3: BRUN/BROWN (14G-22')
- 4: BLANC/WHITE (14G-22')
- 5: BLEU/BLUE (14G-22')
- 6: ROUGE/RED (14G-22')
- 7: NOIR/BLACK (14G-22')
- 8: BOUCHON/PLUG

COULEURS DU FIL
SELON LA COULEUR
SUR CONNECTEUR
- JAUNE AU CENTRE

COLOR AS WRITTEN ON
THE CONNECTOR AND
WITH THE WIRE COLOR.
YELLOW IN THE CENTER

GRUPE ANDERSON 5125, DE LA PLAISANCE CHESTERVILLE, QC, G0P 1J0 TÉL : (819) 382-2052
No PIÈCE :
DERNIER ENREGISTREMENT : 2-mars-22
FICHER : 240312.DWG

240313

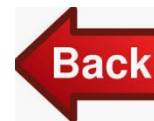

FIL 7 CONDUCTEURS NOIR : 84"

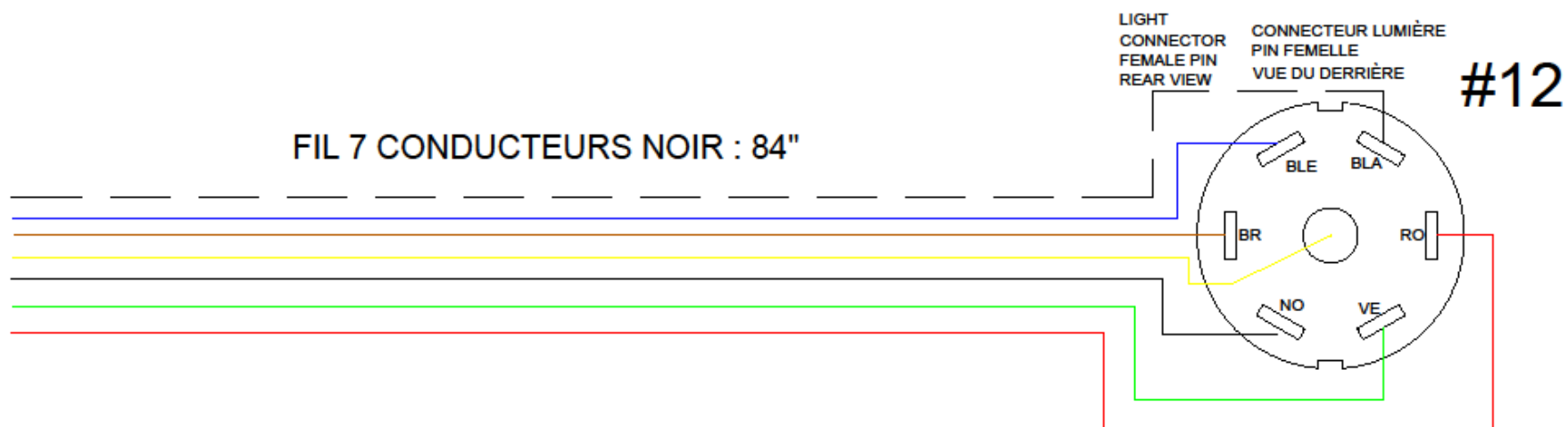

COULEURS DU FIL
SELON LA COULEUR
SUR CONNECTEUR
- JAUNE AU CENTRE

COLOR AS WRITTEN ON
THE CONNECTOR AND
WITH THE WIRE COLOR.
YELLOW IN THE CENTER

GRUPE ANDERSON 5125, DE LA PLAISANCE CHESTERVILLE, QC, G0P 1J0 TÉL : (819) 382-2952
N° PIÈCE :
DERNIER ENREGISTREMENT : 2-mars-22
FICHER : 240313.0102

240314



- 1:JAUNE/YELLOW (14G-12")
- 2:VERT/GREEN (14G-12")
- 3:BRUN/BROWN (14G-12")
- 4:BLANC/WHITE (14G-12")
- 5:BLEU/BLUE (14G-12")
- 6:ROUGE/RED (14G-12")
- 7:NOIR/BLACK (14G-12")
- 8:BOUCHON/PLUG

#9

FIL 7 CONDUCTEUR

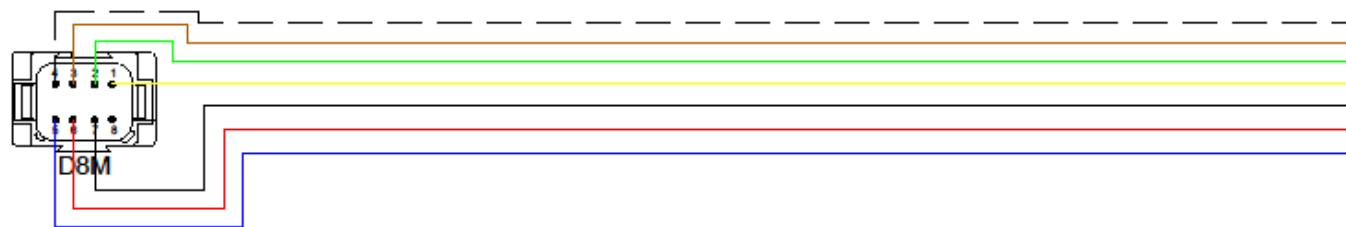

GRUPE ANDERSON 5125, DE LA PLAISANCE CHESTERVILLE, QC, G0P 1J0 TÉL. : (819) 383-2052
No PIÈCE :
DERNIER ENREGISTREMENT : 12-mai-20
FICHER : 240314.DWG

240316-1

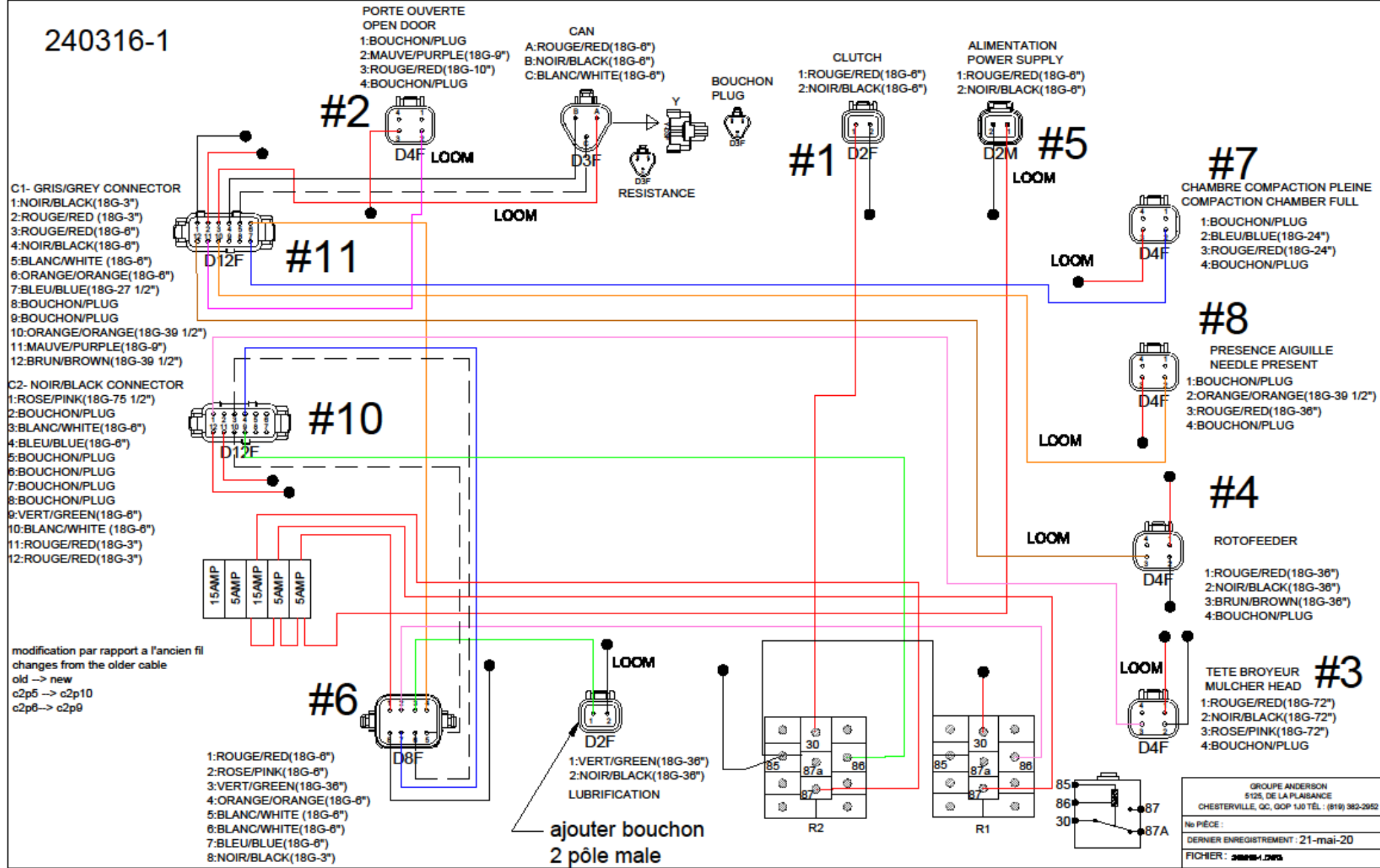

325089-1

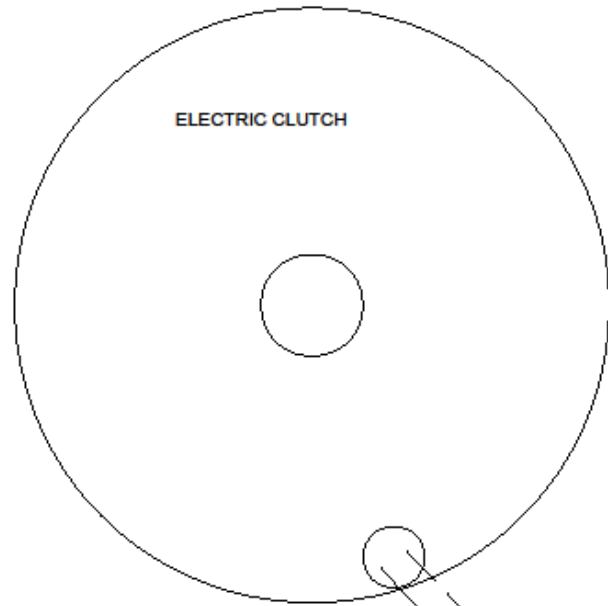

ELECTRIC CLUTCH

LOOM

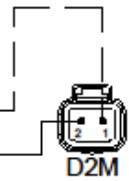

D2M

- 1:BLANC/WHITE (14G-18")
- 2:NOIR/BLACK (14G-18")

#1

GRUPE ANDERSON 5125, DE LA PLAISANCE CHESTERVILLE, QC, G0P 1J0 TEL : (514) 382-2652
No PIÈCE :
DERNIER ENREGISTREMENT : 12-mai-20
FICHER : 325089-1.0WG