



# Evolution

Electric Diagram / Diagramme Électrique

To navigate the electric diagram, you can click on the **red rectangle** that identify the wiring section you want to look up, click on the



button to go back to the main section.

Pour naviguer dans le schéma électrique, vous pouvez cliquer sur les **rectangles rouges** qui identifie la section du câblage que vous souhaitez regarder, cliquez sur le bouton



pour revenir à la section principale.

# DIAGRAMME ÉLECTRIQUE/ELECTRIC DIAGRAM – Pilote auto/ Auto pilot

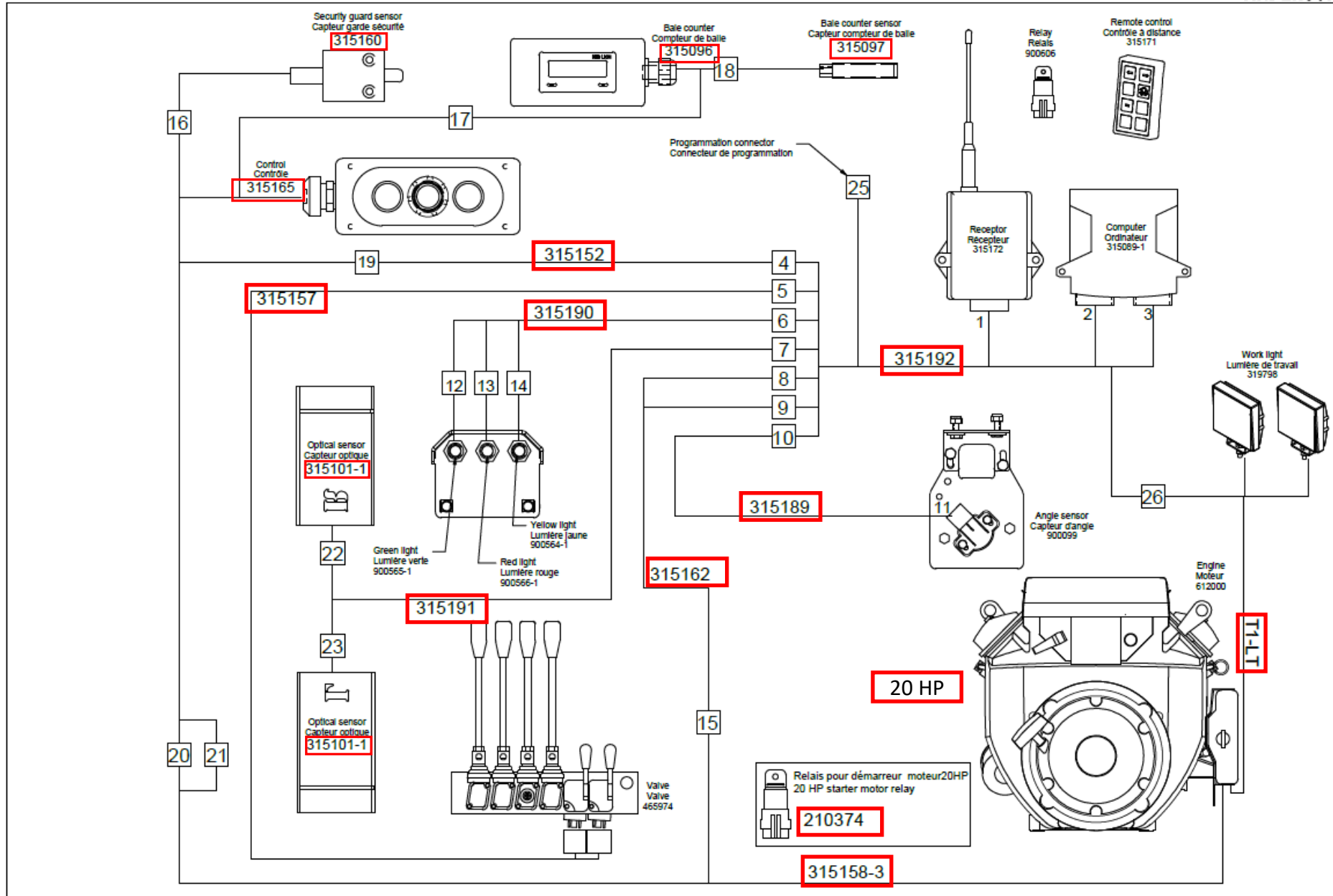

# T1-LT

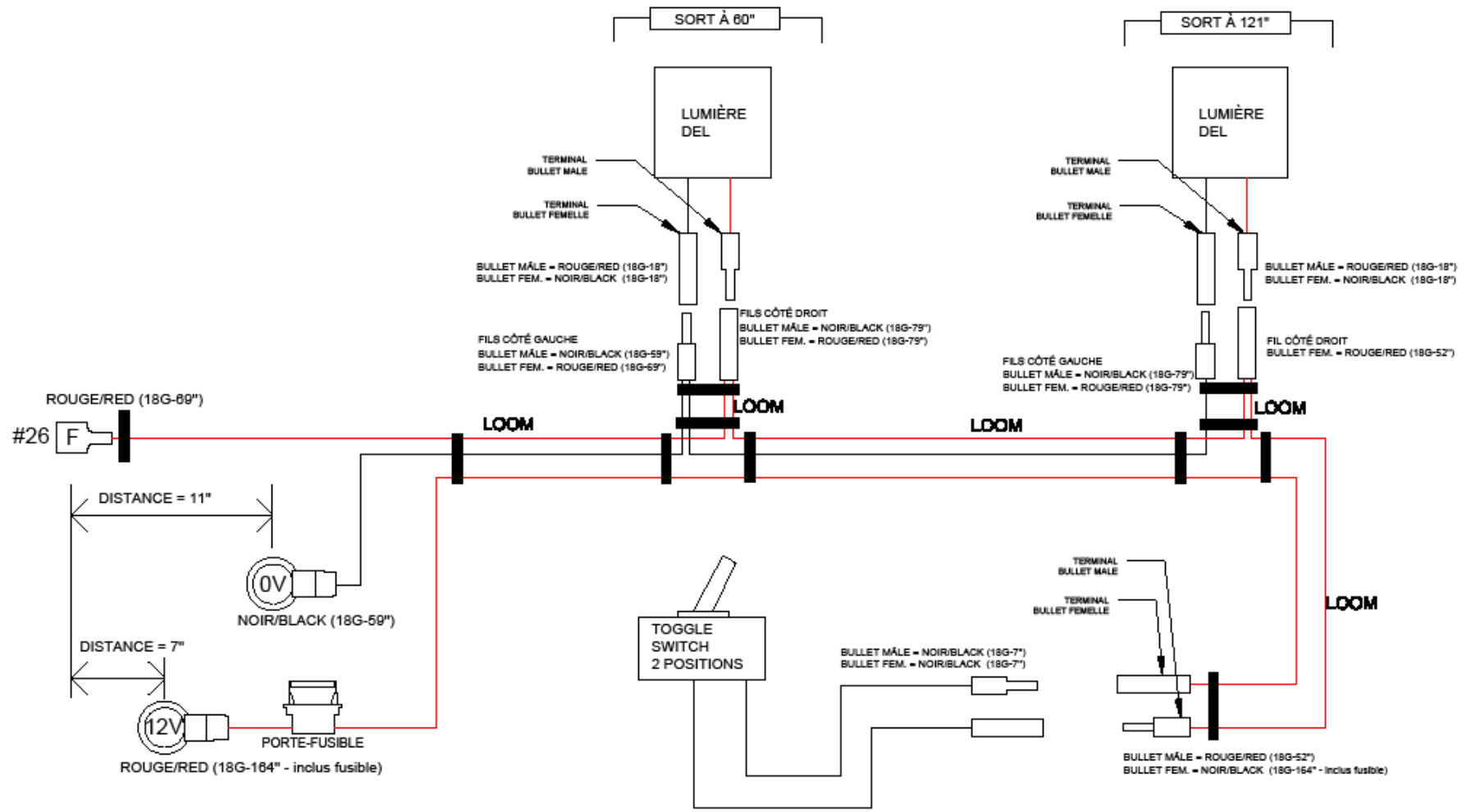

GROUPE ANDERSON 5125, DE LA PLAISANCE CHESTERVILLE, QC, G0P 1J0 TÉL : (819) 382-2952
No PIÈCE :
DERNIER ENREGISTREMENT : 8-juin-20
FICHER : T1-LT.DWG

210374

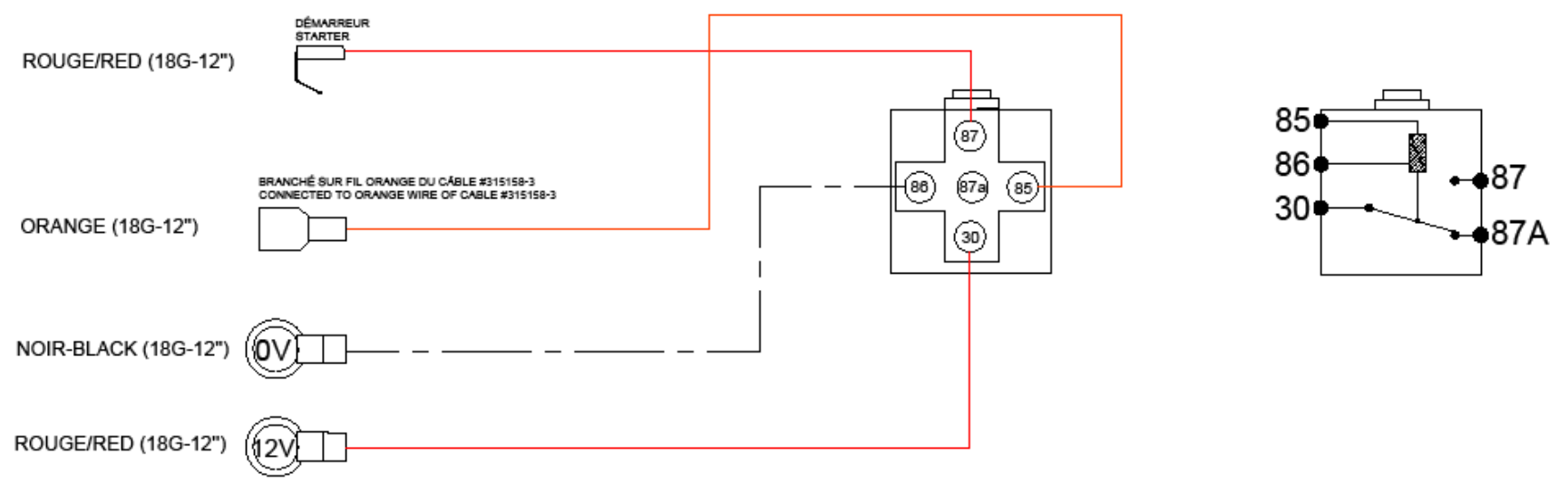

GRUPE ANDERSON 5125, DE LA PLAISANCE CHESTERVILLE, QC, G0P 1J0 TÉL : (514) 382-2952
No PIÈCE :
DERNIER ENREGISTREMENT : 11-juin-20
FICHER : 210374.DWG

315096

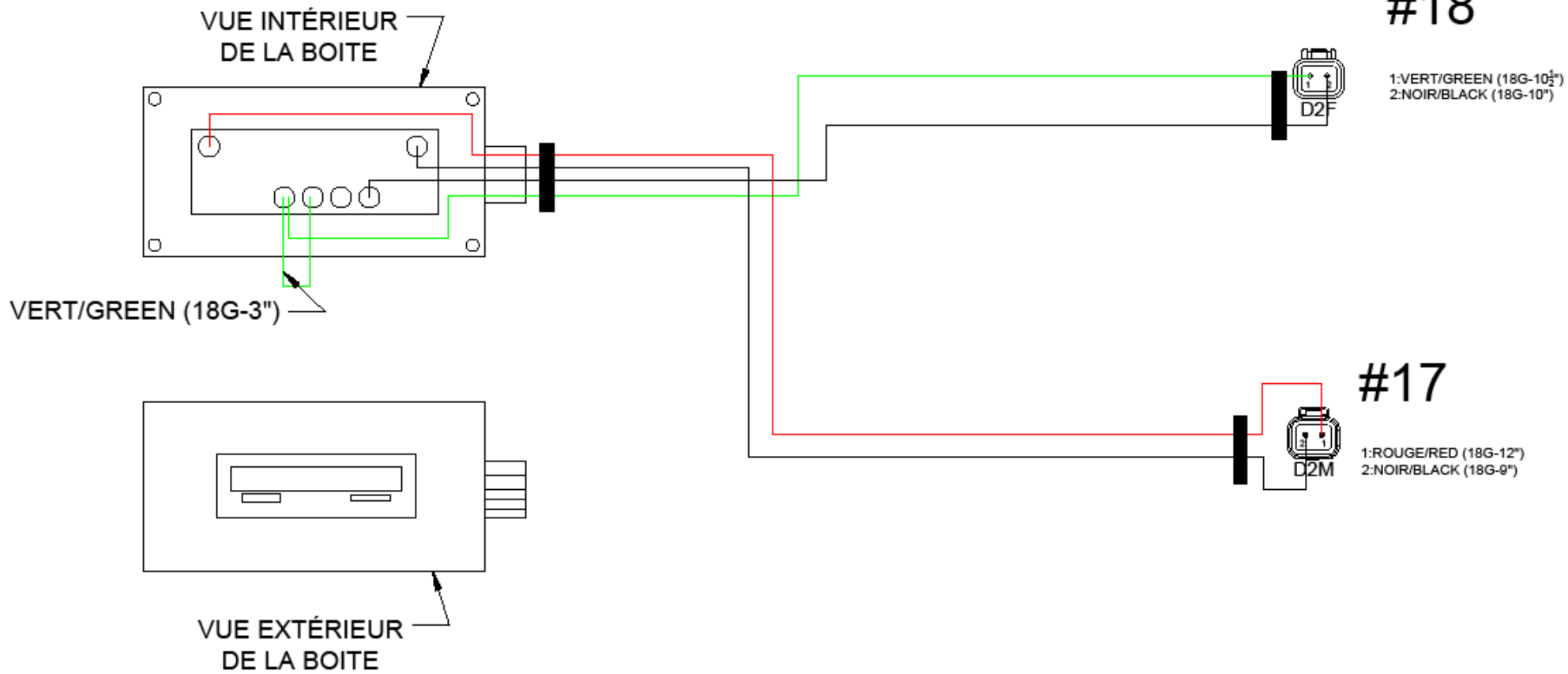

GRUPE ANDERSON 5125, DE LA PLAISANCE CHESTERVILLE, QC, G0P 1J0 TÉL : (514) 382-2952
No PIÈCE :
DERNIER ENREGISTREMENT : 19-juil.-23
FICHER : <b>XXXXXXXXXX</b>

315097

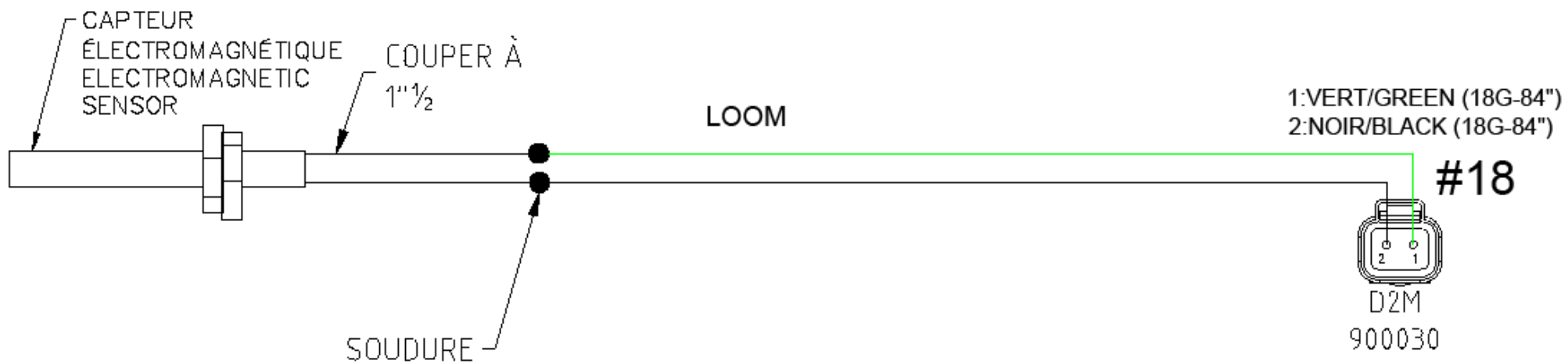

GRUPE ANDERSON 5125, DE LA PLAISANCE CHESTERVILLE, QC, G0P 1J0 TEL : (819) 382-2950
No PIÈCE :
DERNIER ENREGISTREMENT : 2-mars-22
FICHER : 315087.DWG

315101

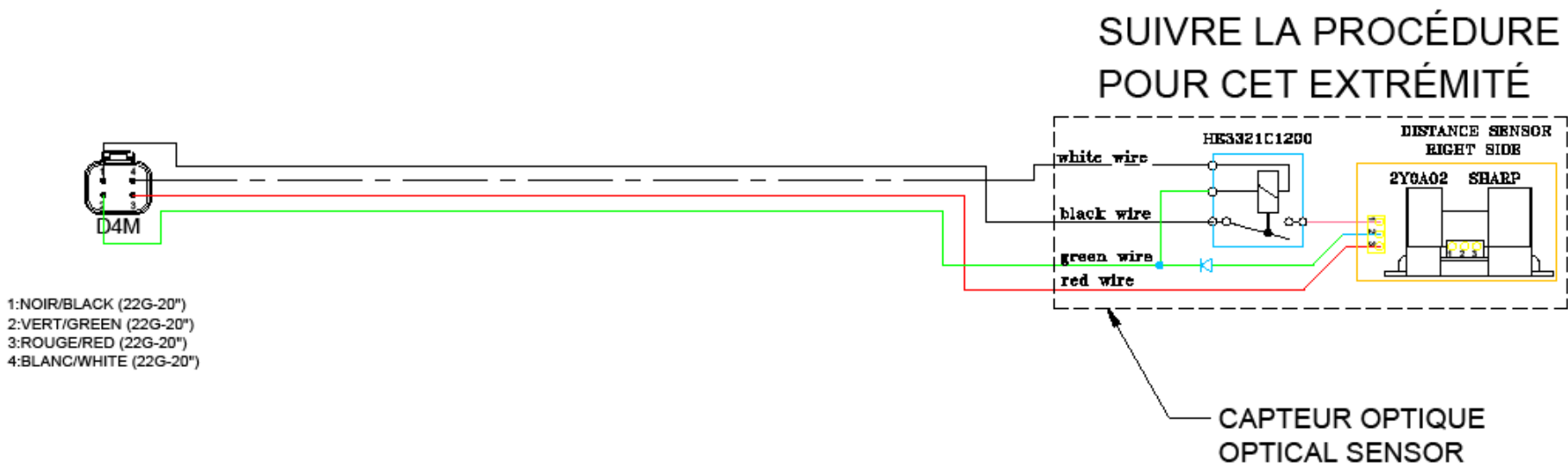

GRUPE ANDERSON 5125, DE LA PLAISANCE CHESTERVILLE, QC, G0P 1J0 TEL : (819) 382-2952
No PIÈCE :
DERNIER ENREGISTREMENT : 14-juil.-21
FICHER : 31 01DI.DWG

315152



#4

- 1:ROUGE/RED (18G-100")
- 2:ROUGE/RED (18G-100")
- 3:VERT/GREEN (18G-100")
- 4:VERT/GREEN (18G-100")

D4M  
900032

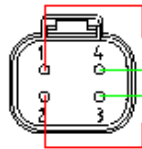

ATTN

LOOM

- 1:ROUGE/RED (18G-100")
- 2:ROUGE/RED (18G-100")
- 3:VERT/GREEN (18G-100")
- 4:VERT/GREEN (18G-100")

#19

D4F  
900033

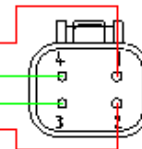

ATTN

GRUPE ANDERSON 5125, DE LA PLAISANCE CHESTERVILLE, QC, G0P 1J0 TEL. : (819) 382-2952
No PIÈCE :
DERNIER ENREGISTREMENT : 7-juin-23
FICHER : 315152.DWG



315155-4

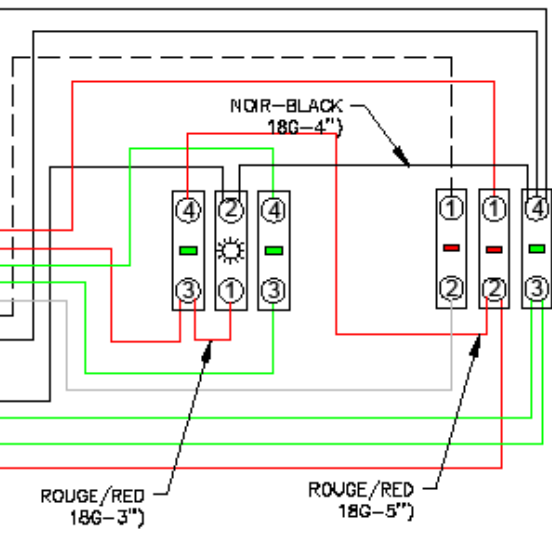
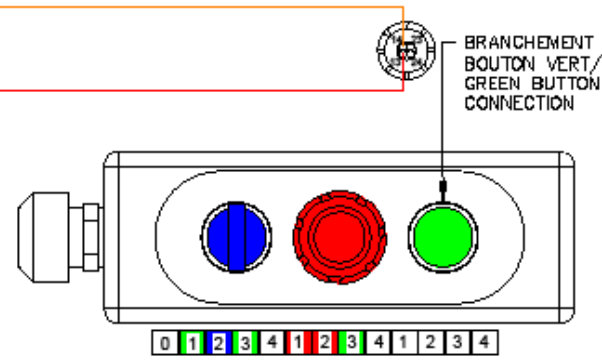
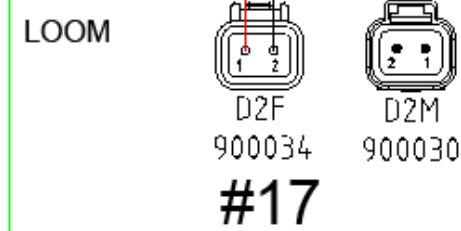
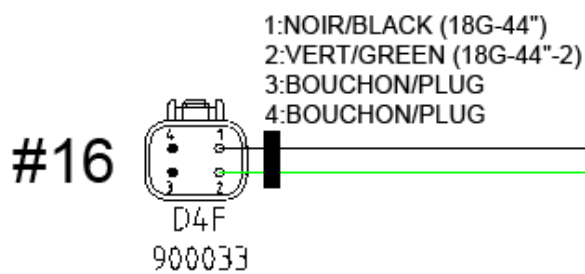
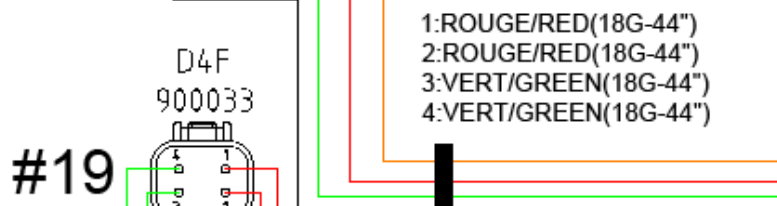
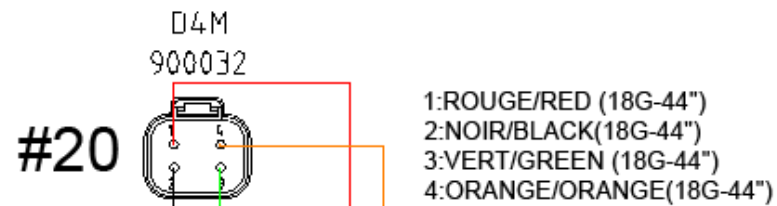

GROUPE ANDERSON 5125, DE LA PLAISANCE CHESTERVILLE, QC, G0P 1J0 TEL.: (819) 382-2052	
No PIÈCE:	
DERNIER ENREGISTREMENT: 2-mars-22	
FICHER: 315155-4.DWG	

315157

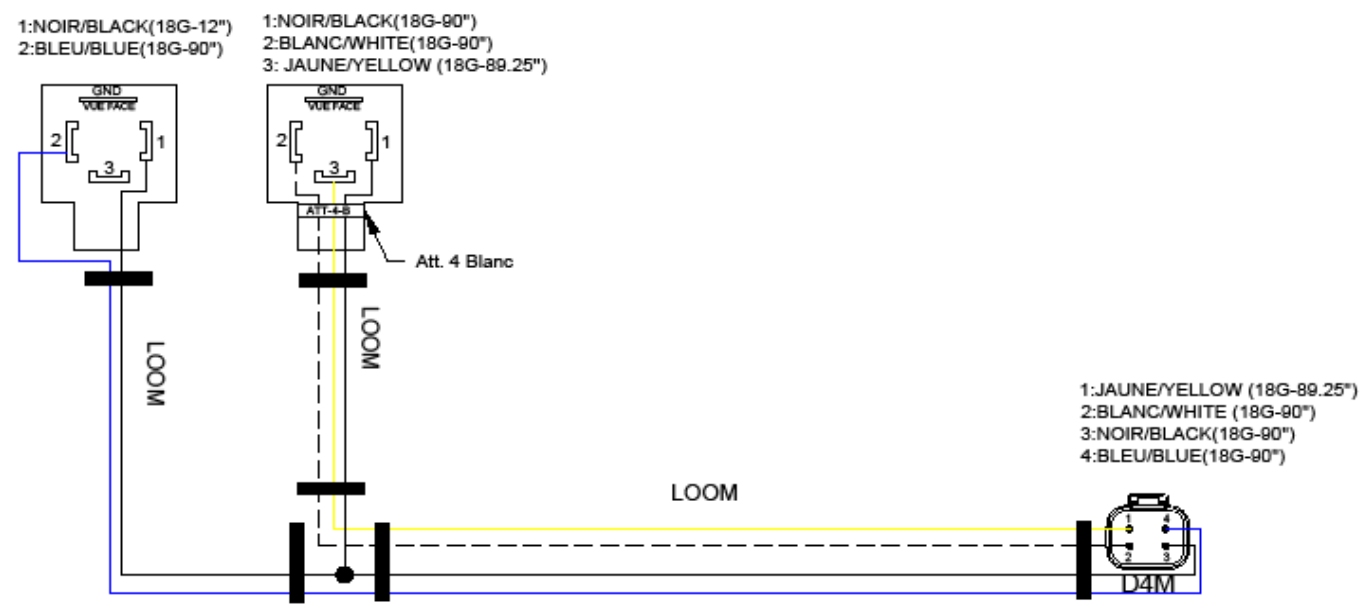

GRUPE ANDERSON 5125, DE LA PLAISANCE CHESTERVILLE, QC, G0P 1J0 TEL : (514) 382-2952
No PIÈCE :
DERNIER ENREGISTREMENT : 1-juil.-21
FICHER : 310157.DWC

315158-3

- 1:BLANC/WHITE (18G-100")
- 2:GRIS/GREY (18G-100")



#21

LOOM

12 1/2"

PORTE-FUSIBLE

+12V

900116

900131

GRIS/GREY (18G-100")  
CHARGEUR BATTERIE  
BATTERY CHARGER  
BLANC/WHITE (18G-100")

900132

900113

VERT/GREEN (18G-100")  
ARRET MOTEUR  
STOP ENGINE  
VERT/GREEN (18G-3")

900132

900112

ORANGE/ORANGE (18G-100")  
DÉMARREUR  
STARTER

900105

NOIR/BLACK (18G-100")  
MASSE  
GROUND

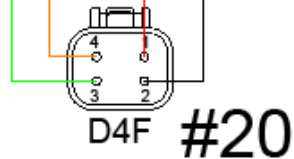

#20

- 1:ROUGE/RED (18G-88")
- 2:NOIR/BLACK (18G-100")
- 3:VERT/GREEN (18G-100")
- 4:ORANGE/ORANGE (18G-100")

#15

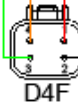

- 1:ROUGE/RED (18G-3")
- 2:NOIR/BLACK (18G-3")
- 3:VERT/GREEN (18G-3")
- 4:ORANGE/ORANGE (18G-3")

SORT À 87.5"

GROUPE ANDERSON 5125, DE LA PLAISANCE CHESTERVILLE, QC, G0P 1J0 TÉL : (514) 382-2952	
No PIÈCE :	
DERNIER ENREGISTREMENT : 21-mai-21	
FICHER : 310158-3.DWG	

315160



GRUPE ANDERSON 5125, DE LA PLAISANCE CHESTERVILLE, QC, G0P 1J0 TEL. : (819) 382-2952
No PIÈCE :
DERNIER ENREGISTREMENT : 21-mai-20
FICHER : 315160.DWG

315162

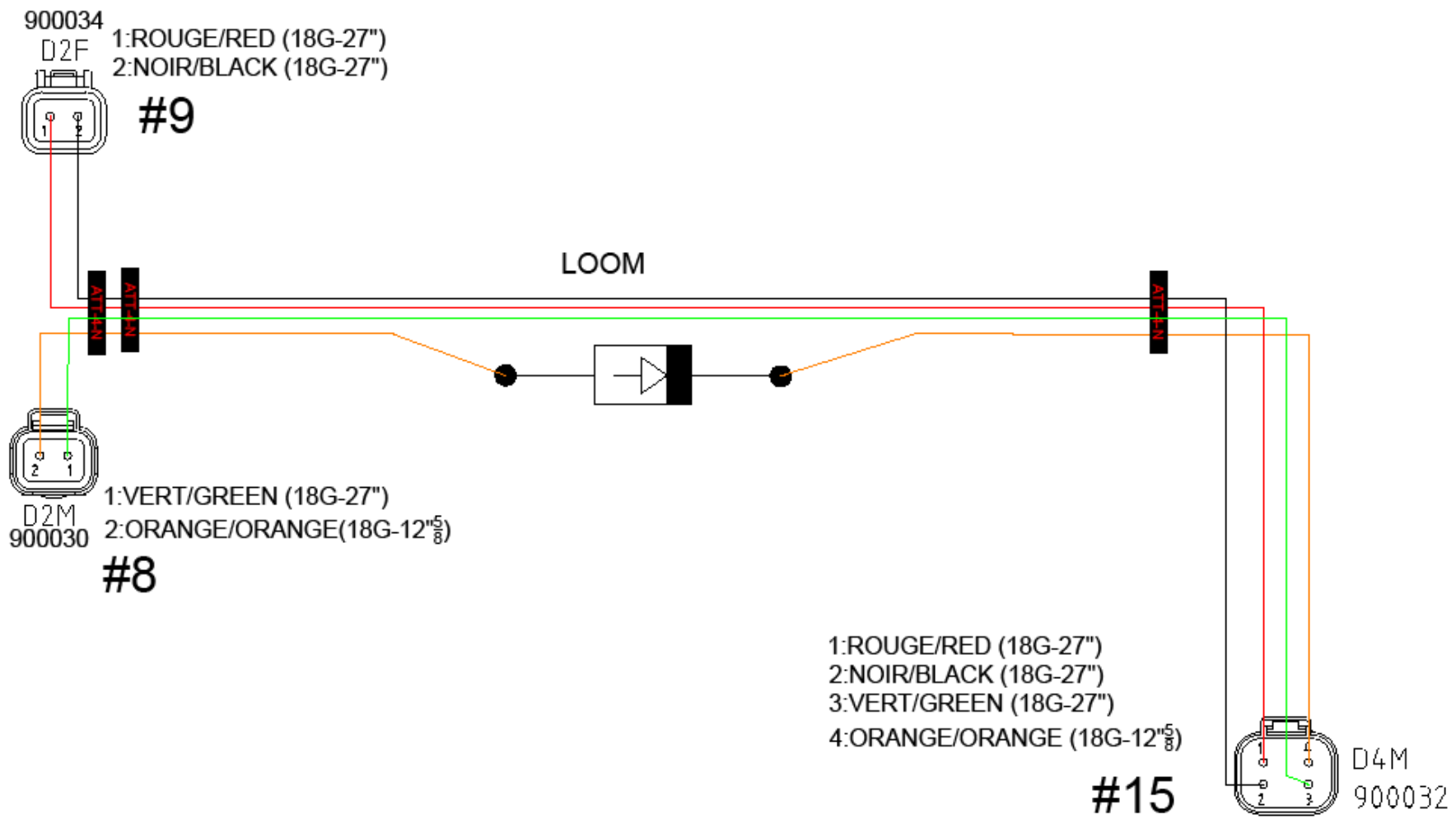

GRUPE ANDERSON 5125, DE LA PLAISANCE CHESTERVILLE, QC, G0P 1J0 TEL : (819) 382-2952
No PIÈCE :
DERNIER ENREGISTREMENT : 14-mai-20
FICHER : 315162.DWG

315189

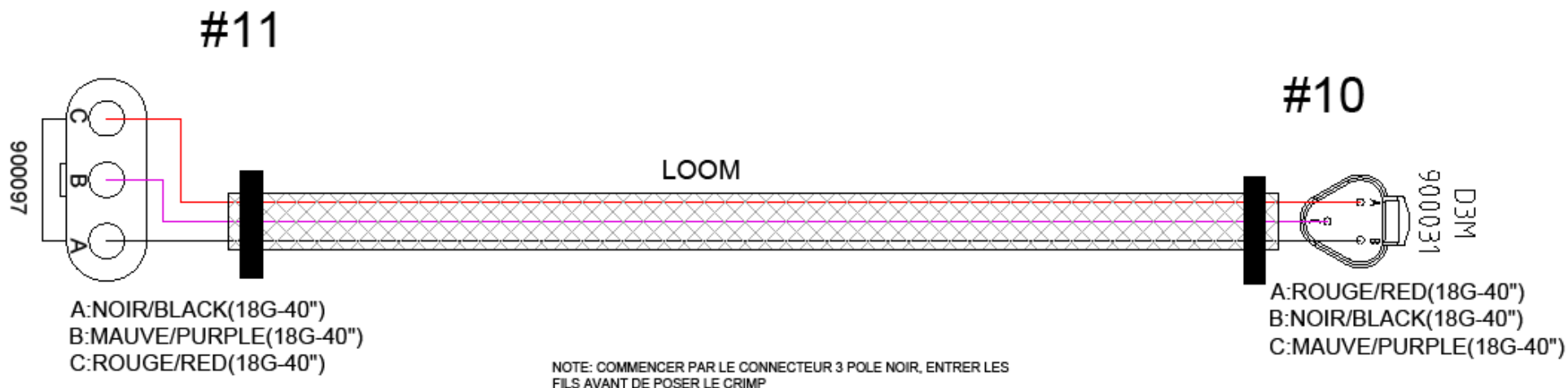

A:NOIR/BLACK(18G-40")  
B:MAUVE/PURPLE(18G-40")  
C:ROUGE/RED(18G-40")

A:ROUGE/RED(18G-40")  
B:NOIR/BLACK(18G-40")  
C:MAUVE/PURPLE(18G-40")

NOTE: COMMENCER PAR LE CONNECTEUR 3 POLE NOIR, ENTRER LES  
FILS AVANT DE POSER LE CRIMP

GRUPE ANDERSON 5125, DE LA PLAISANCE CHESTERVILLE, QC, G0P 1J0 TEL : (819) 382-2952
No PIÈCE :
DERNIER ENREGISTREMENT : 14-mai-20
FICHER : 315189.DWG

315190

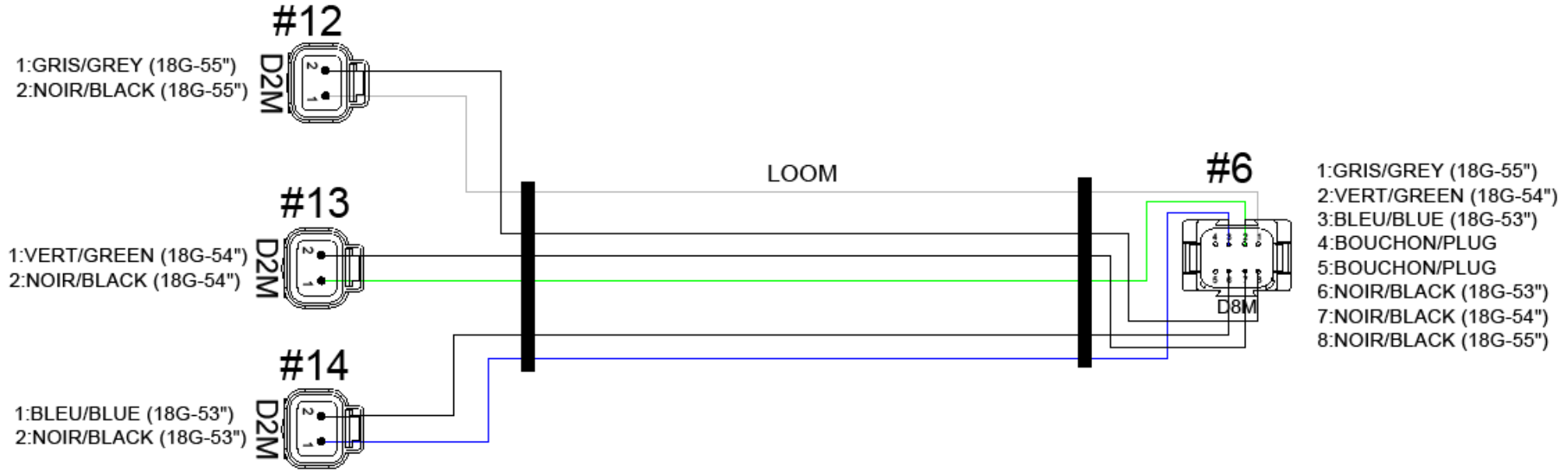

GRUPE ANDERSON 5125, DE LA PLAISANCE CHESTERVILLE, QC, G0P 1J0 TEL : (819) 382-2952
No PIÈCE :
DERNIER ENREGISTREMENT : 31-mars-21
FICHIER : 315190LOW

315191



#22

- 1:BRUN/BROWN (18G-113")
- 2:NOIR/BLACK (18G-113")
- 3:ROUGE/RED (18G-113")
- 4:BLEU/BLEU (18G-113")

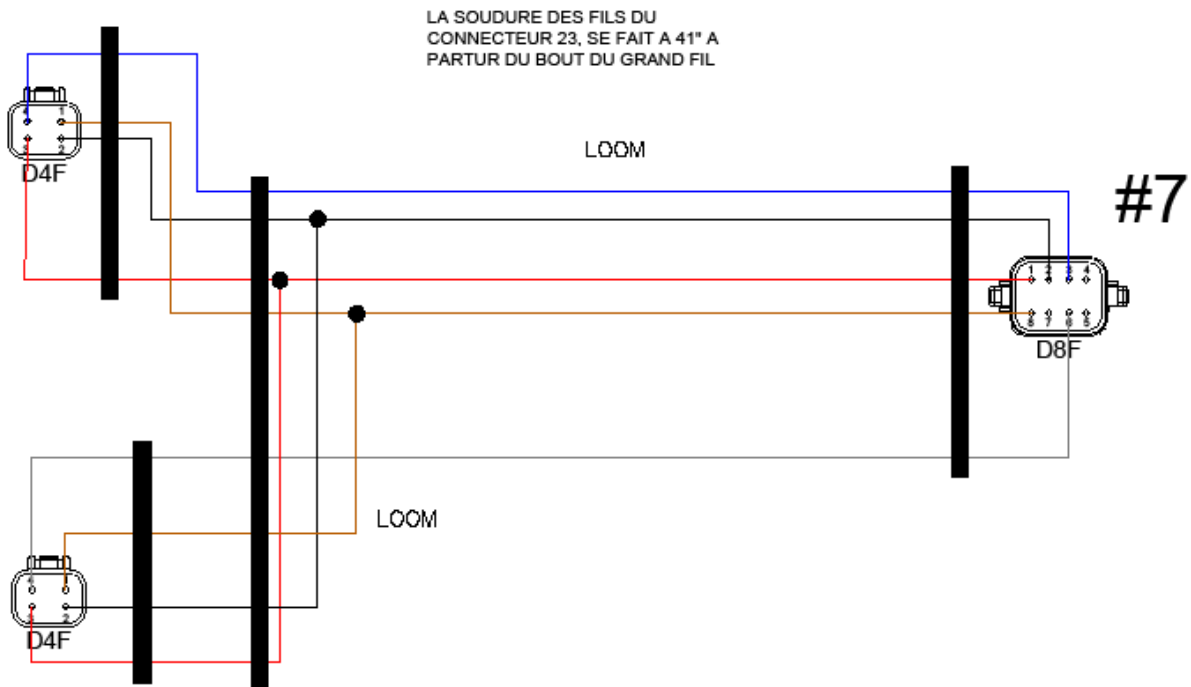

LA SOUDURE DES FILS DU  
CONNECTEUR 23, SE FAIT A 41° A  
PARTIR DU BOUT DU GRAND FIL

LOOM

#7

- 1:ROUGE/RED (18G-113")
- 2:NOIR/BLACK (18G-113")
- 3:BLEU/BLEU (18G-113")
- 4:BOUCHON/PLUG
- 5:BOUCHON/PLUG
- 6:GRIS/GREY (18G-113")
- 7:BOUCHON/PLUG
- 8:BRUN/BROWN(18G-113")

#23

- 1:BRUN/BROWN (18G-41")
- 2:NOIR/BLACK (18G-41")
- 3:ROUGE/RED (18G-41")
- 4:GRIS/GREY (18G-113")

LOOM

GRUPE ANDERSON 5135, DE LA PLAISANCE CHESTERVILLE, QC, QCP 1J0 TÉL : (819) 382-2952
No PIÈCE :
DERNIER ENREGISTREMENT : 3-nov.-20
FICHER : 31 0191.DWG



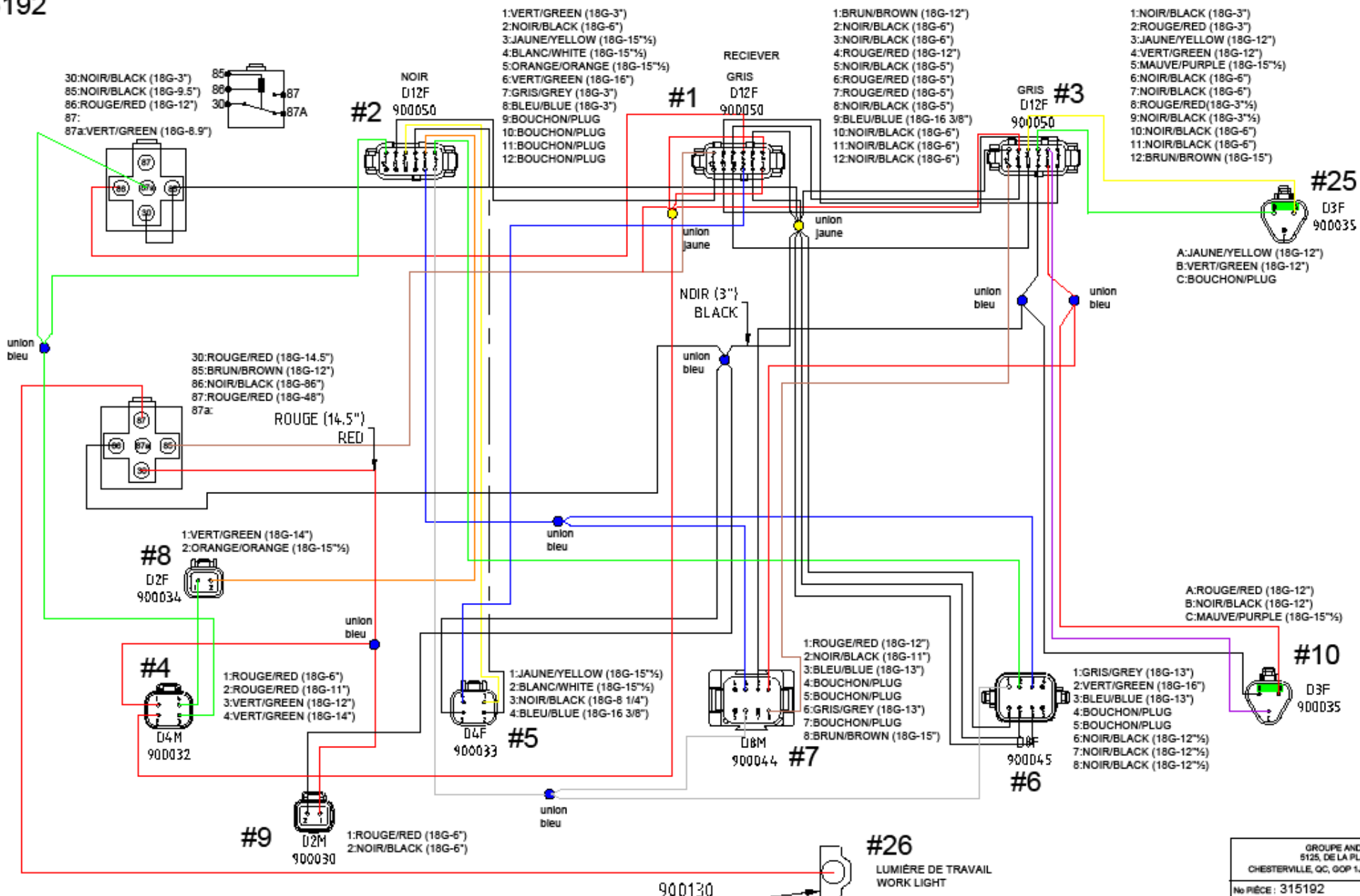

GROUPE ANDERSON 5125, DE LA PLAISANCE CHESTERVILLE, QC, G0P 1J0 TEL : (819) 382-2952	
No PIÈCE : 315192	
DERNIER ENREGISTREMENT : 6-juil.-21	
FICHER : 315192.DWG	

# IFX 20HP

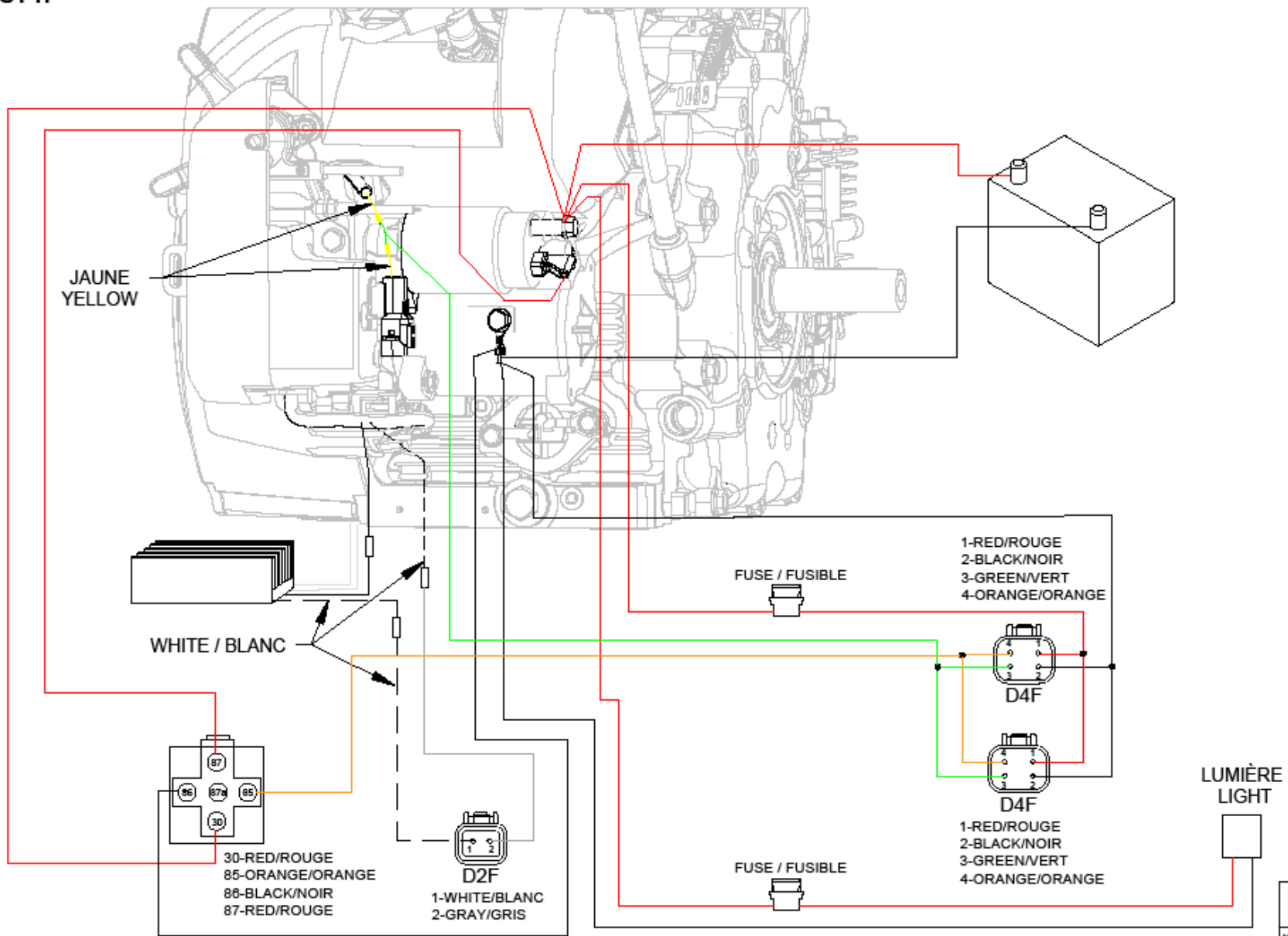

JAUNE  
YELLOW

WHITE / BLANC

- 30-RED/ROUGE
- 85-ORANGE/ORANGE
- 88-BLACK/NOIR
- 87-RED/ROUGE

- D2F**
- 1-WHITE/BLANC
  - 2-GRAY/GRIS

FUSE / FUSIBLE

- 1-RED/ROUGE
- 2-BLACK/NOIR
- 3-GREEN/VERT
- 4-ORANGE/ORANGE

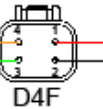
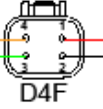

- 1-RED/ROUGE
- 2-BLACK/NOIR
- 3-GREEN/VERT
- 4-ORANGE/ORANGE

FUSE / FUSIBLE

LUMIÈRE  
LIGHT

GROUPE ANDERSON 5125, DE LA PLAISANCE CHESTERVILLE, QC, G0P 1J0 TÉL : (514) 382-2952
No PIÈCE :
DERNIER ENREGISTREMENT : 29-nov.-23
FICHER : _FX_P1.2760



# IFX 20 HP

BL	Black	Gr	Gray
Y	Yellow	Bu	Blue
Bu	Blue	BL/Y	Black / Yellow
G	Green	BL/W	Black / White
R	Red	W/Bu	White / Blue
W	White		

COMBINATION SWITCH				
IGN	GND	BAT	LO	ST
OFF				
ON				
ST				

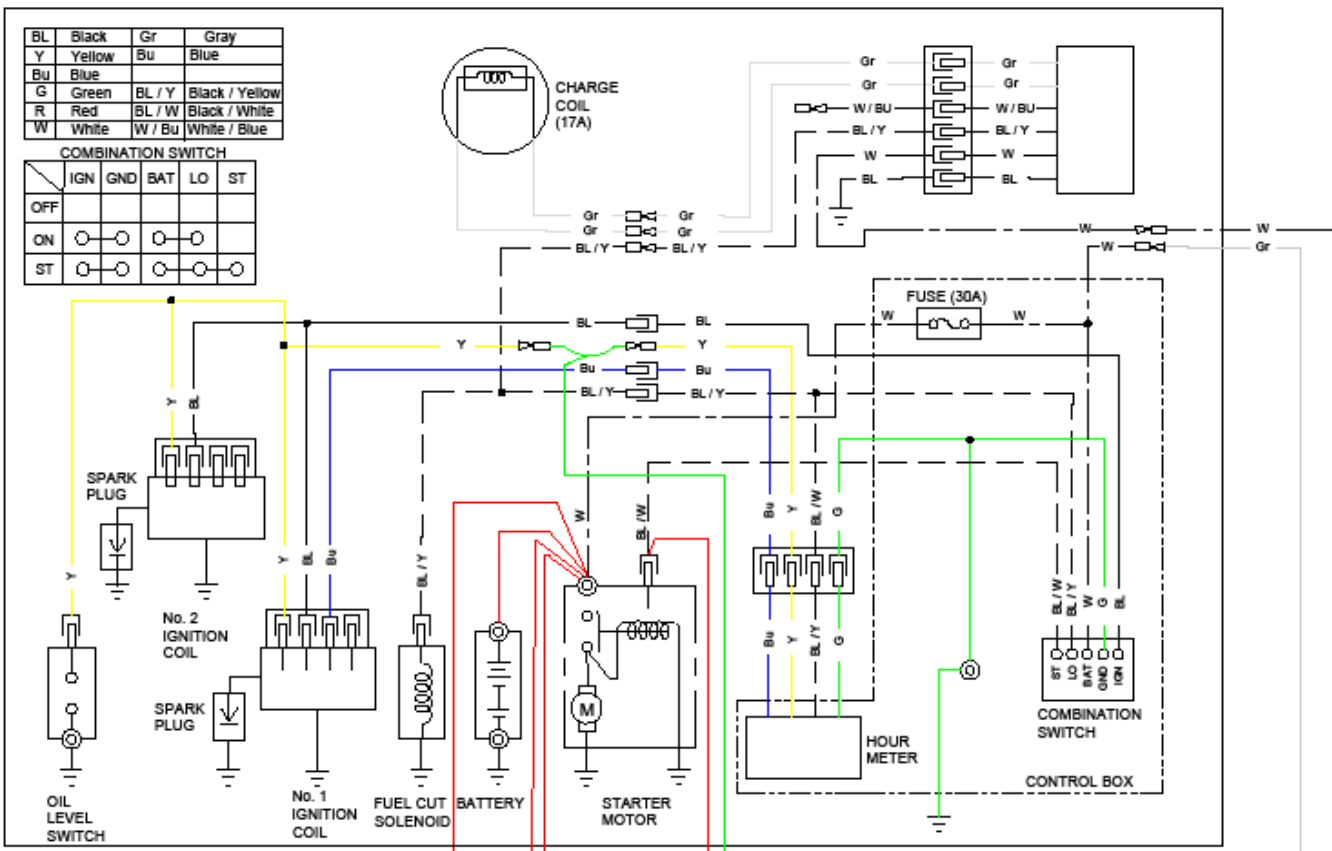

**#20**  
 1 - RED / ROUGE  
 2 - BLACK / NOIR  
 3 - GREEN / VERT  
 4 - ORANGE / ORANGE

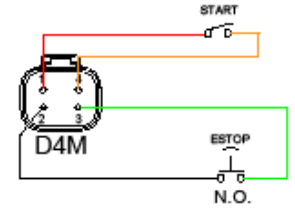

**#21**  
 1 - WHITE / BLANC  
 2 - GREY / GRIS

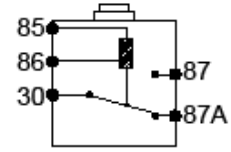
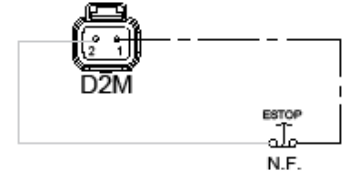

**#21**  
 1 - WHITE / BLANC  
 2 - GREY / GRIS

