



To navigate the electric diagram, you can click on the **red rectangle** that identify the wiring section you want to look up, click on the



button to go back to the main section.

Pour naviguer dans le schéma électrique, vous pouvez cliquer sur les **rectangles rouges** qui identifie la section du câblage que vous souhaitez regarder, cliquez sur le bouton



pour revenir à la section principale.

# IFX - HYBX - NWS

Electric Diagram / Diagramme Électrique

# DIAGRAMME ÉLECTRIQUE/ELECTRIC DIAGRAM – Conduite à distance / Remote control

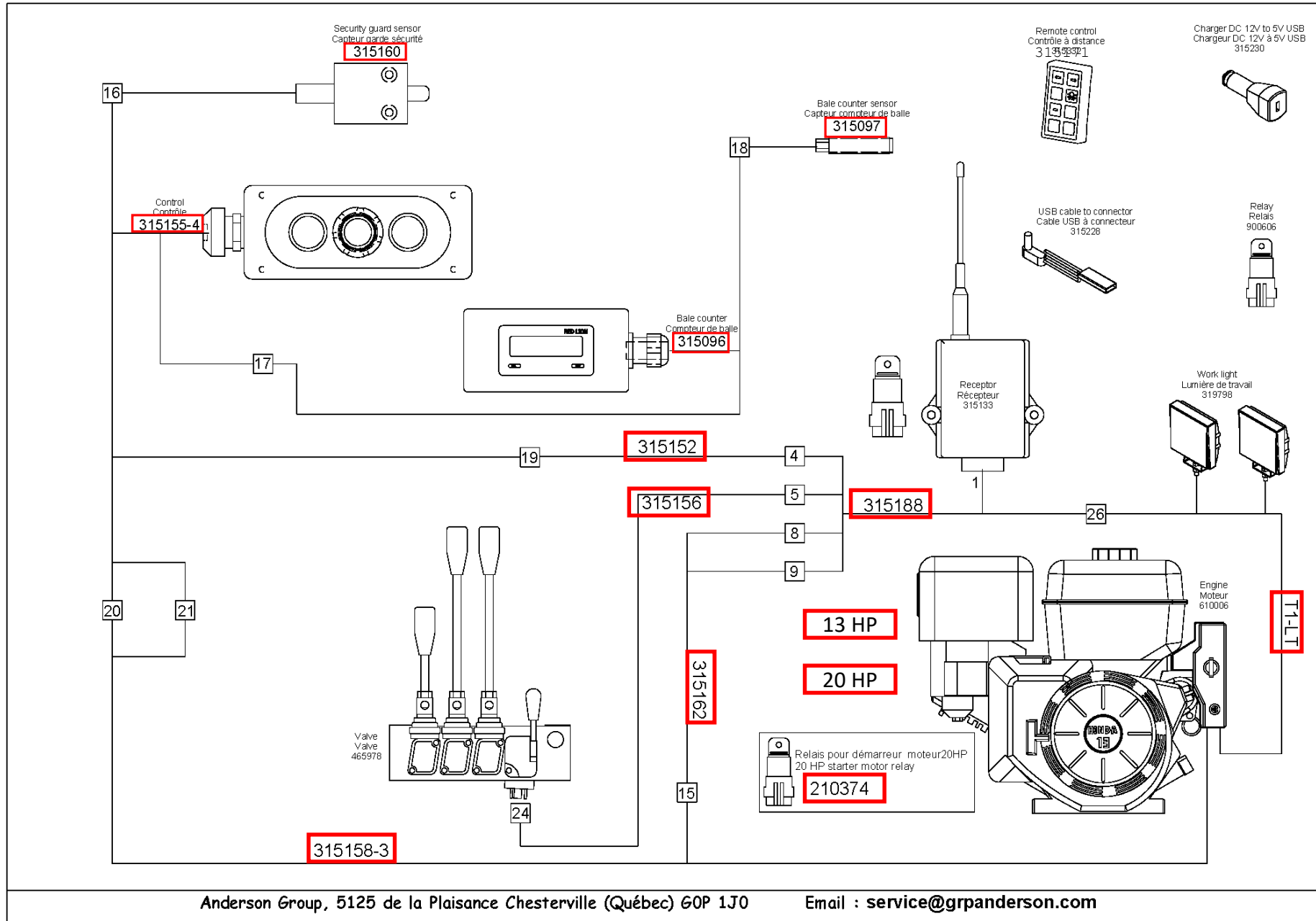

T1-LT

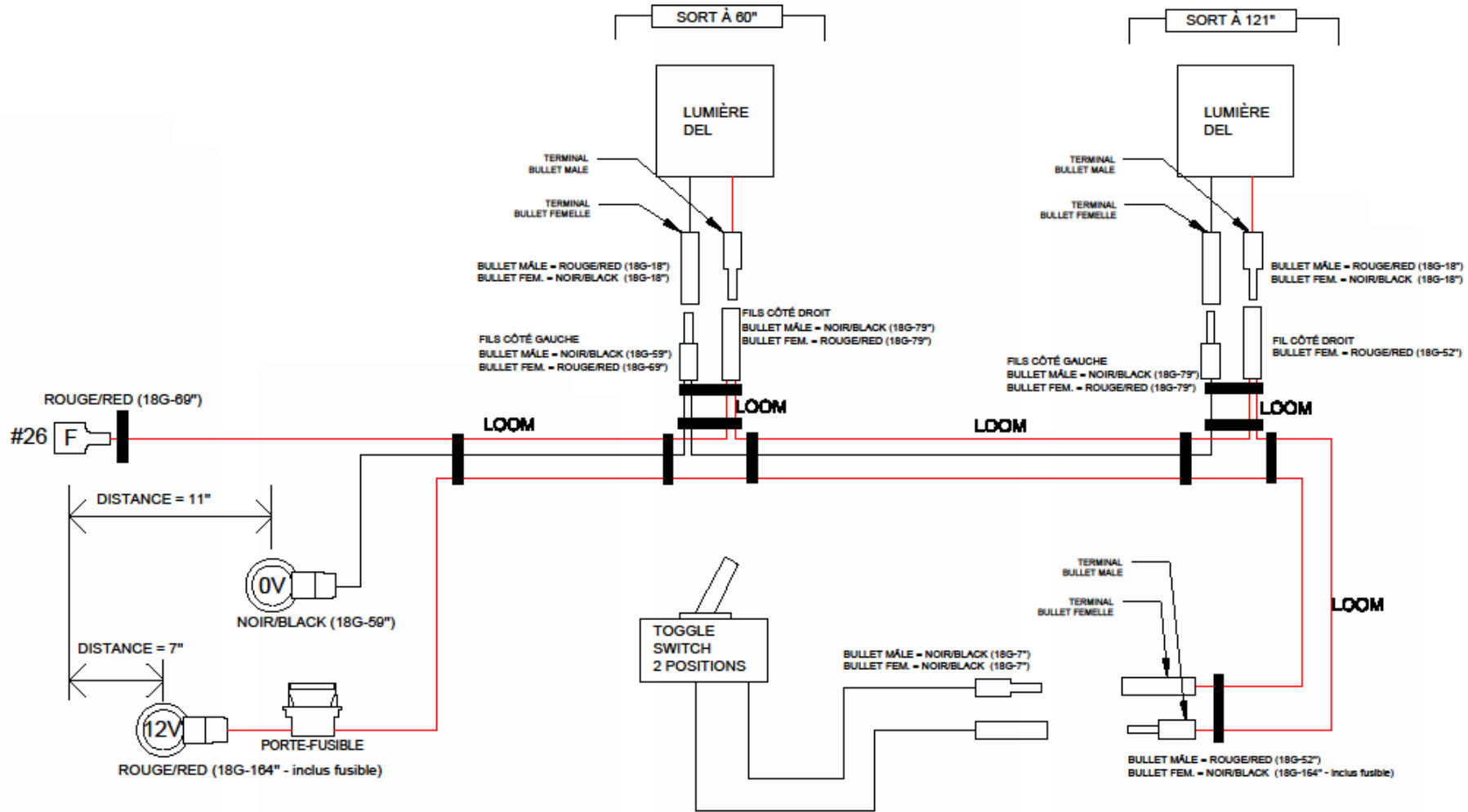

GROUPE ANDERSON  
 5125, DE LA PLAISANCE  
 CHESTERVILLE, QC, GOP 1J0 TÉL. : (819) 382-2952  
 No PIÈCE :  
 DERNIER ENREGISTREMENT : 8-juin-20  
 FICHER : T1-LT.DWG

210374

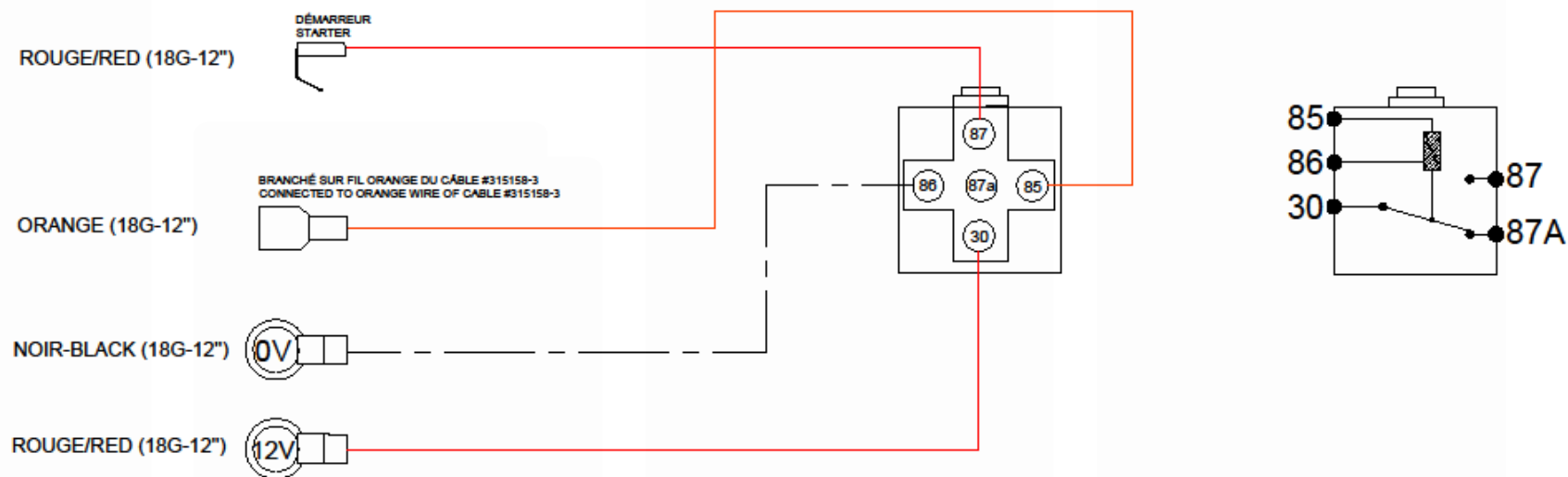

GRUPE ANDERSON 5125, DE LA PLAISANCE CHESTERVILLE, QC, G0P 1J0 TÉL : (819) 382-2952
No PIÈCE :
DERNIER ENREGISTREMENT : 11-juin-20
FICHER : 210374.DWG

315096

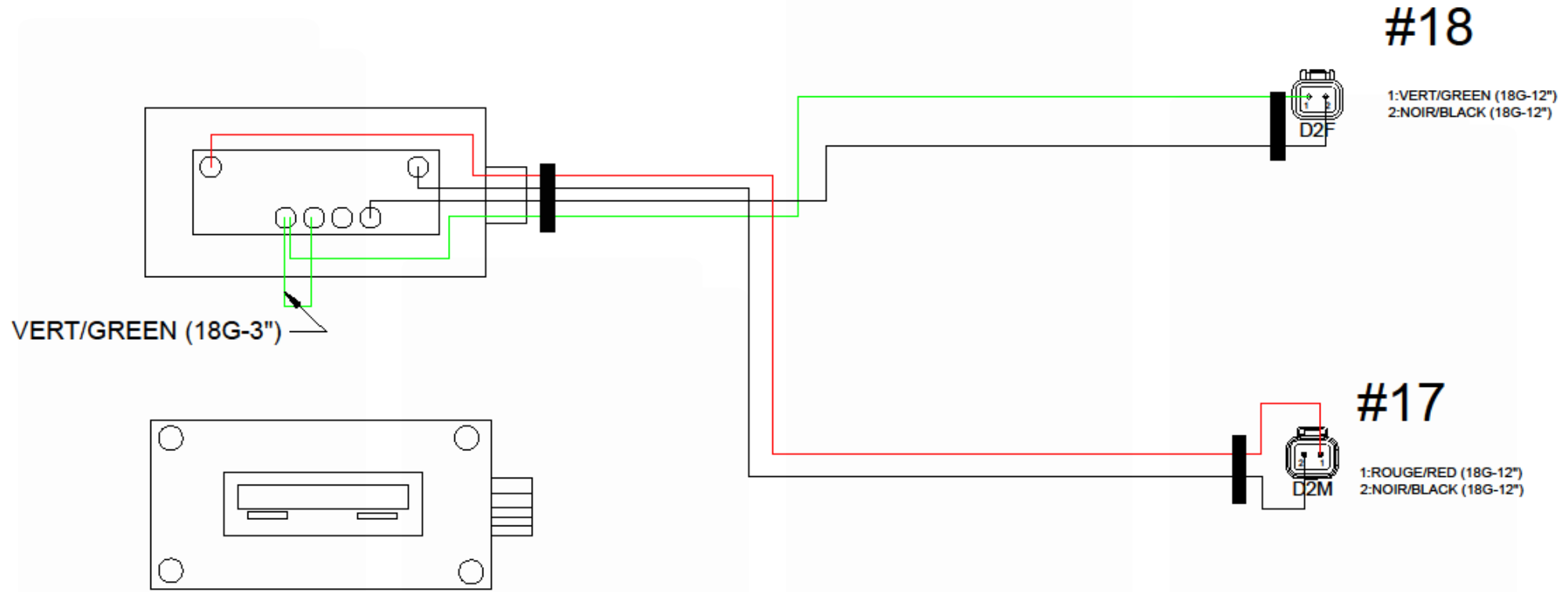

#18

1:VERT/GREEN (18G-12")  
2:NOIR/BLACK (18G-12")

#17

1:ROUGE/RED (18G-12")  
2:NOIR/BLACK (18G-12")

GRUPE ANDERSON 5125, DE LA PLAISANCE CHESTERVILLE, QC, G0P 1J0 T�L : (819) 382-2952
No PI�CE :
DERNIER ENREGISTREMENT : 1-juil.-21
FICHER : 310096.0100

315097

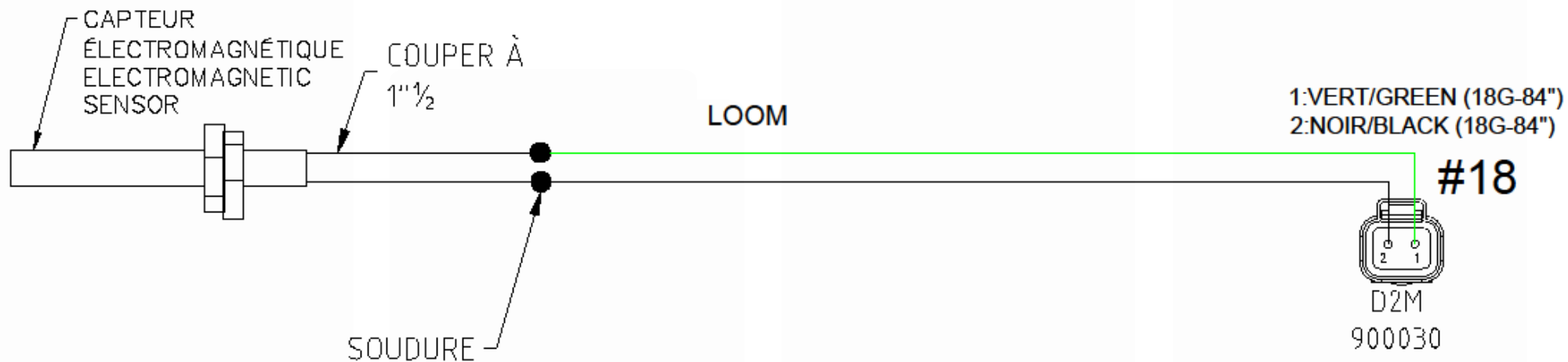

GRUPE ANDERSON 5125, DE LA PLAISANCE CHESTERVILLE, QC, G0P 1J0 TEL : (819) 382-2950
No PIÈCE :
DERNIER ENREGISTREMENT : 2-mars-22
FICHER : 315087.DWG

315152



#4

- 1:ROUGE/RED (18G-96")
- 2:ROUGE/RED (18G-96")
- 3:VERT/GREEN (18G-96")
- 4:VERT/GREEN (18G-96")

D4M  
900032

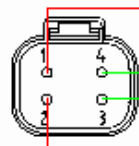

LOOM

- 1:ROUGE/RED (18G-96")
- 2:ROUGE/RED (18G-96")
- 3:VERT/GREEN (18G-96")
- 4:VERT/GREEN (18G-96")

#19

D4F  
900033

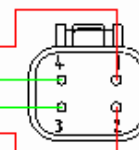

GRUPE ANDERSON 5125, DE LA PLAISANCE CHESTERVILLE, QC, G0P 1J0 TEL : (819) 382-2950
No PIÈCE :
DERNIER ENREGISTREMENT : 14-mai-20
FICHER : 315152.DWG

315155-4

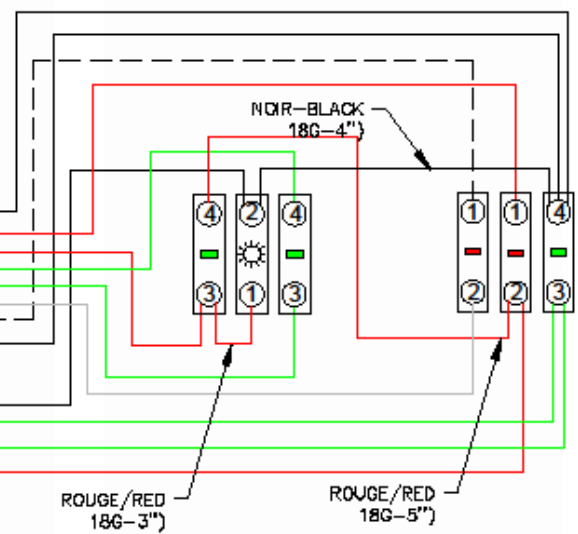
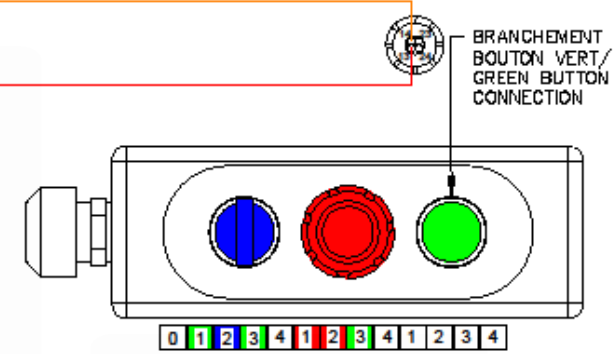
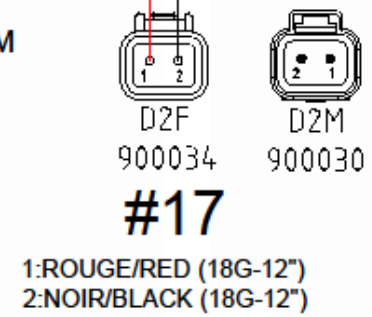
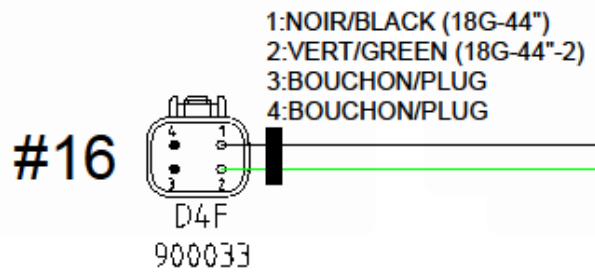
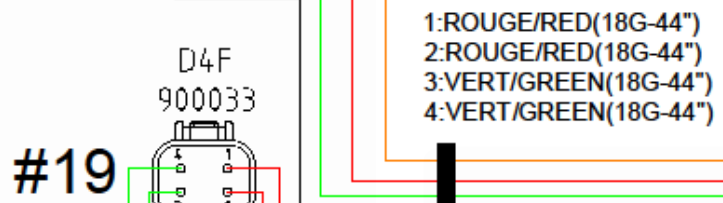
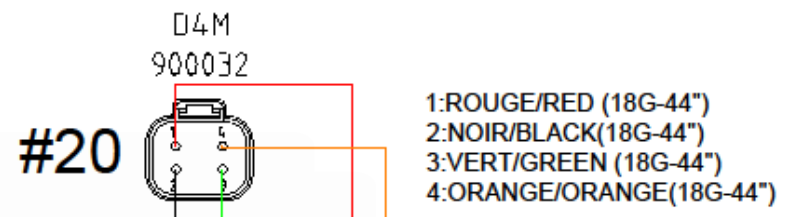

GROUPE ANDERSON 5125, DE LA PLAISANCE CHESTERVILLE, QC, G0P 1J0 TEL : (514) 382-2652
No PIÈCE :
DERNIER ENREGISTREMENT : 2-mars-22
FICHER : 315155-4.DWG



315156

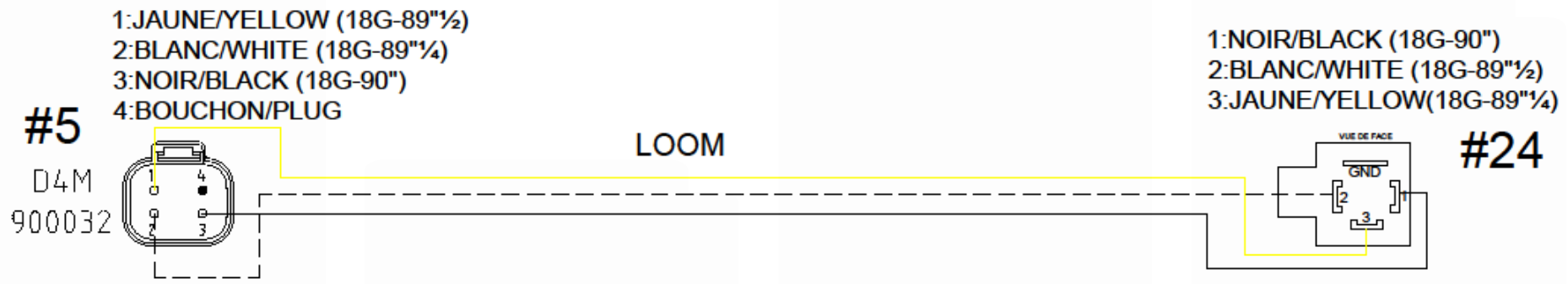

GRUPE ANDERSON 5125, DE LA PLAISANCE CHESTERVILLE, QC, G0P 1J0 TÉL : (514) 382-2052
No PIÈCE :
DERNIER ENREGISTREMENT : 21-mai-20
FICHER : 315156.DWG



315160

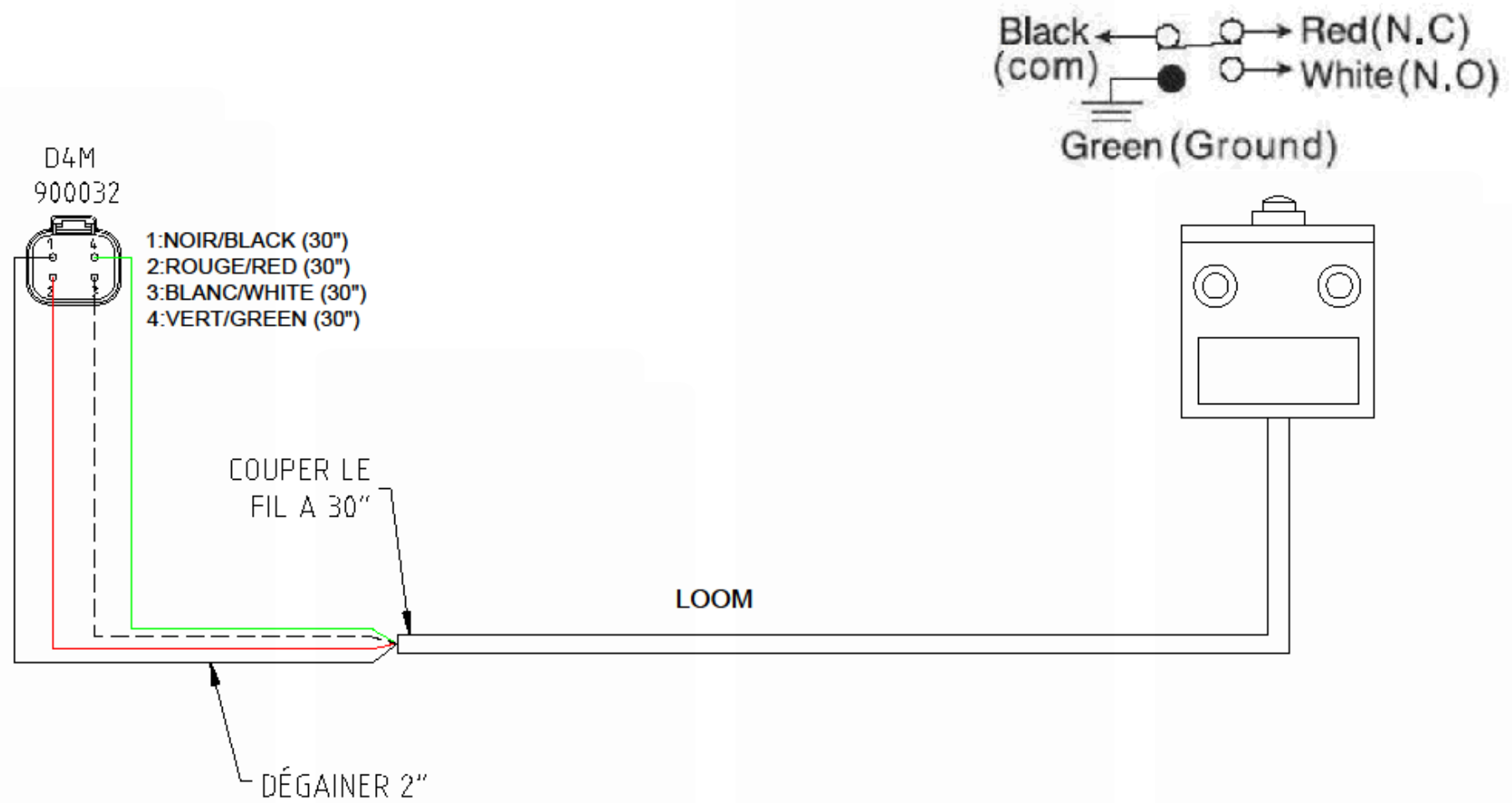

GRUPE ANDERSON 5125, DE LA PLAISANCE CHESTERVILLE, QC, G0P 1J0 TÉL : (819) 382-2952
No PIÈCE :
DERNIER ENREGISTREMENT : 21-mai-20
FICHER : 315160.DWG

315162

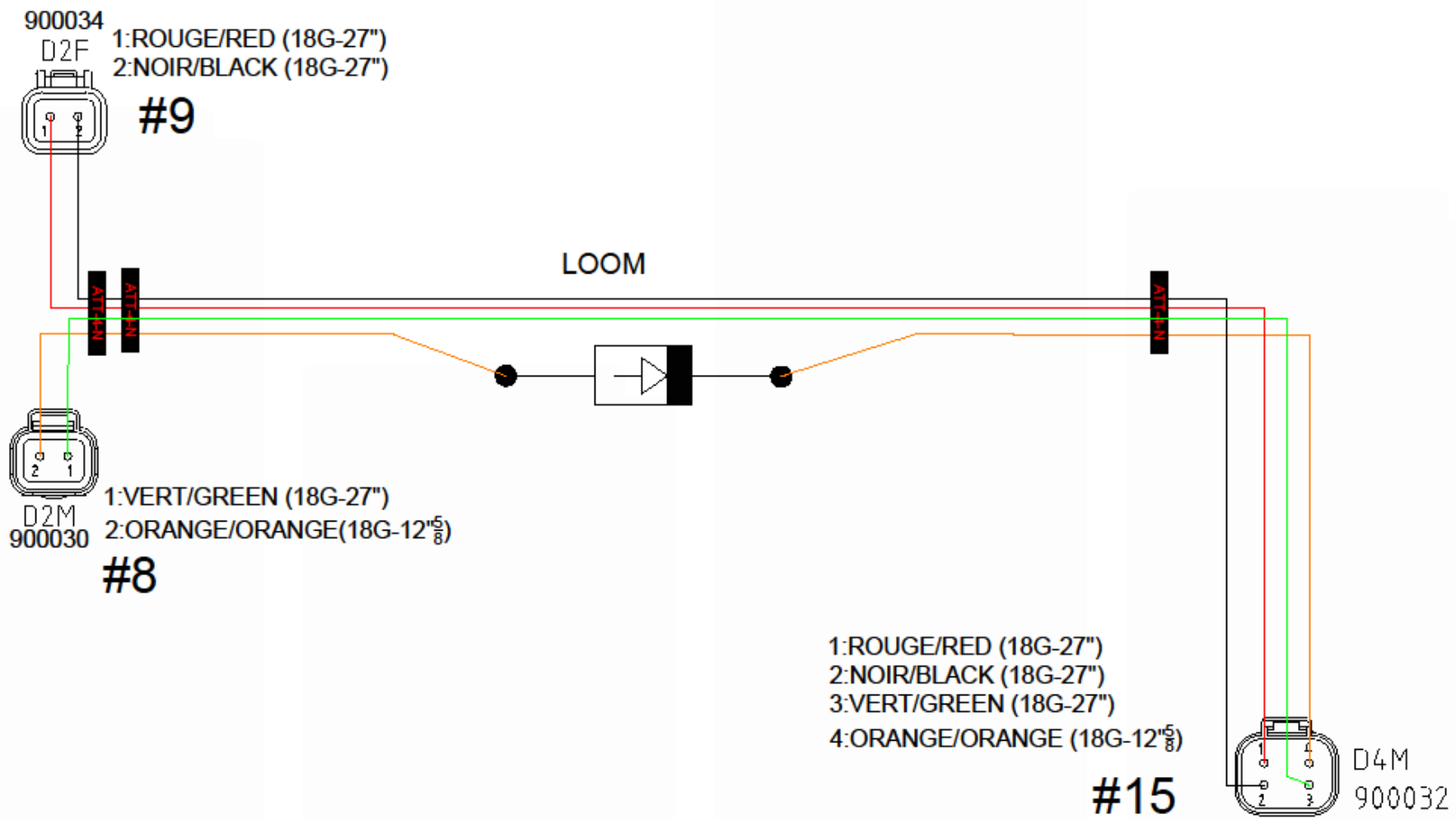

GRUPE ANDERSON 5125, DE LA PLAISANCE CHESTERVILLE, QC, G0P 1J0 TEL : (819) 382-2952
No PIÈCE :
DERNIER ENREGISTREMENT : 14-mai-20
FICHER : 315162.DWG



315188

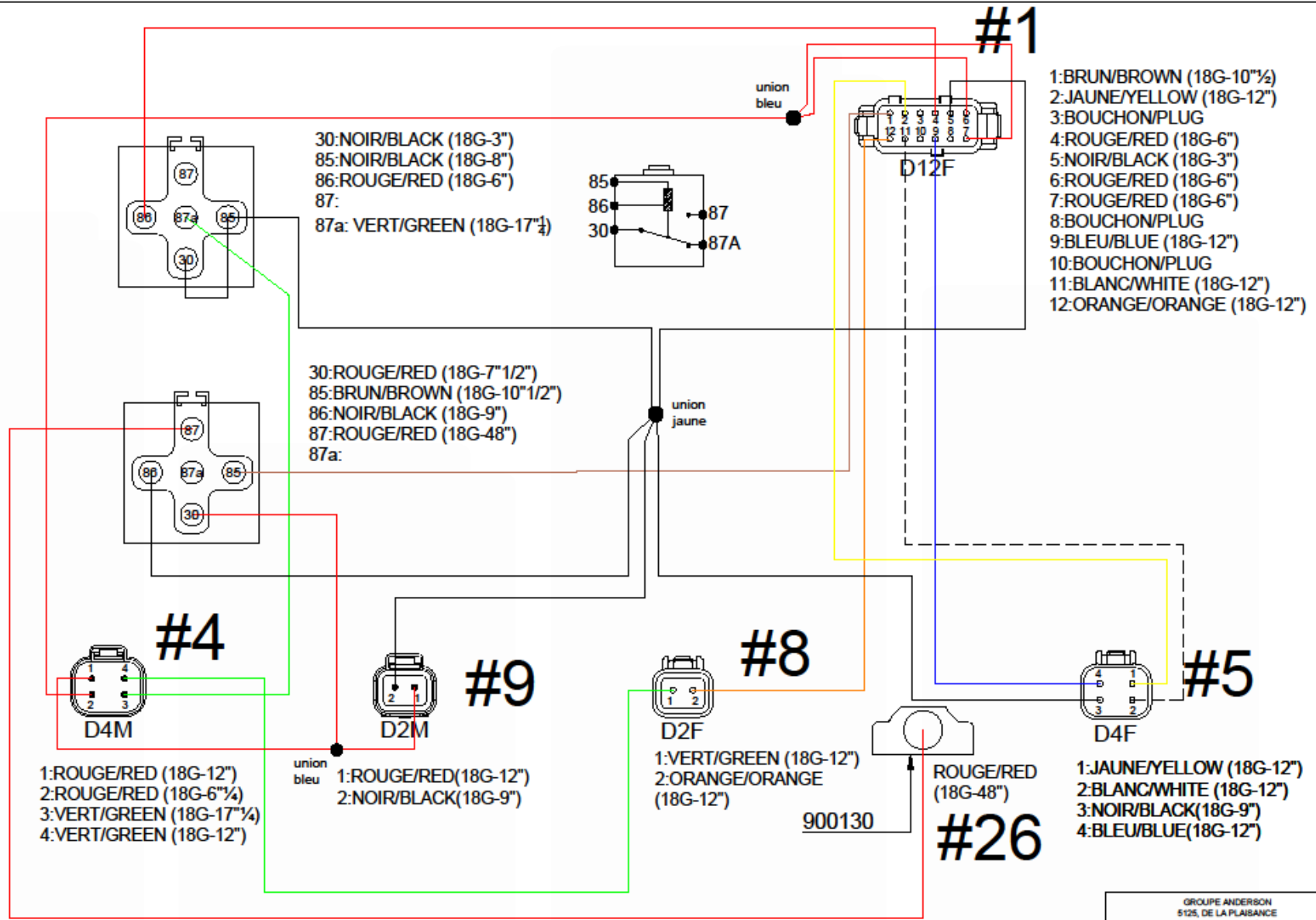

GRUPE ANDERSON  
 5125, DE LA PLAISANCE  
 CHESTERTVILLE, QC, GOP 1J0 TEL : (819) 382-2952

No PIÈCE :

DERNIER ENREGISTREMENT : 9-nov.-20

FICHER : 31 010BLDWC



MOTOR ELECTRICAL  
WIRING / FILAGE  
ÉLECTRIQUE DU  
MOTEUR

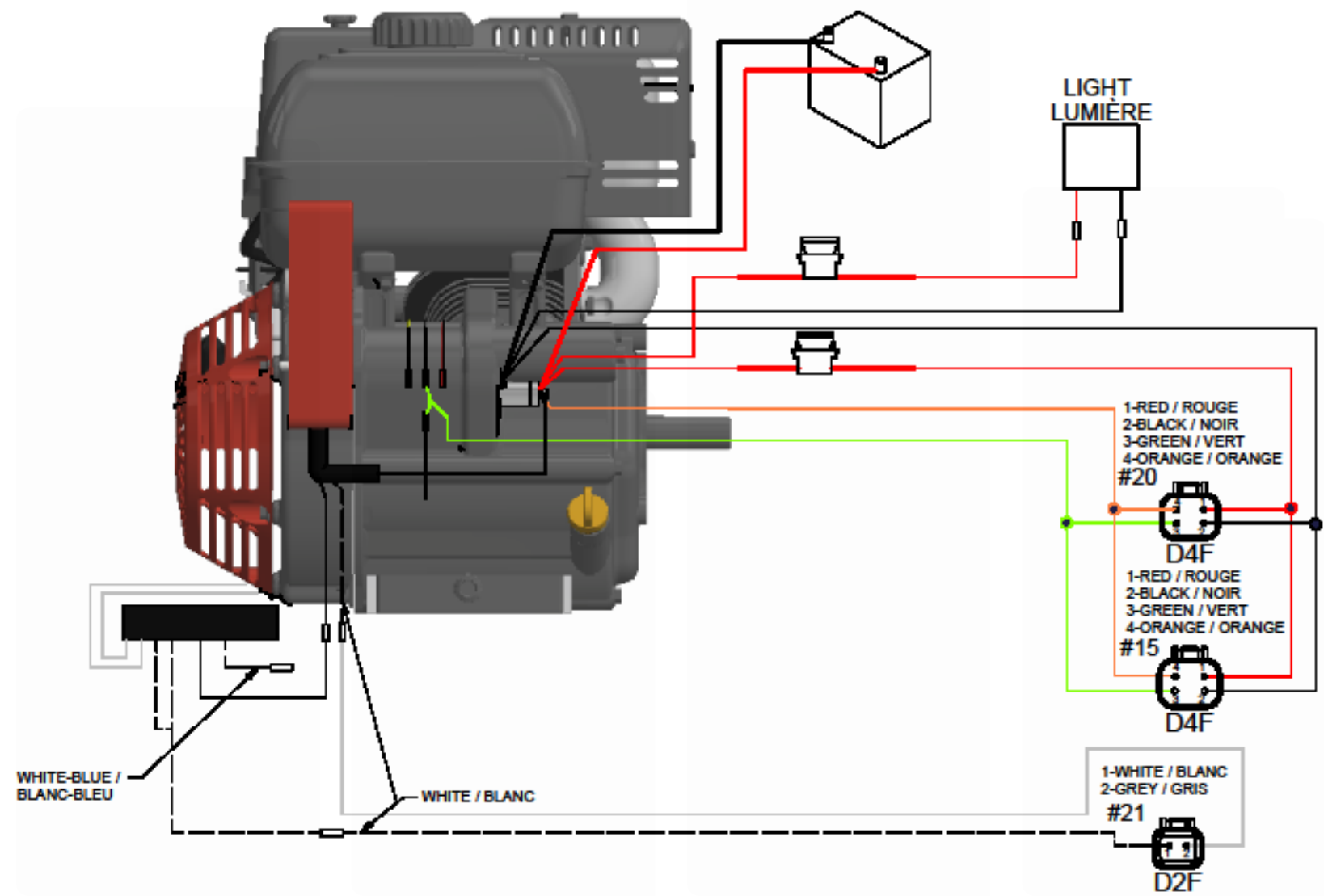

IFX 13 HP

18A CHARGING SYSTEM

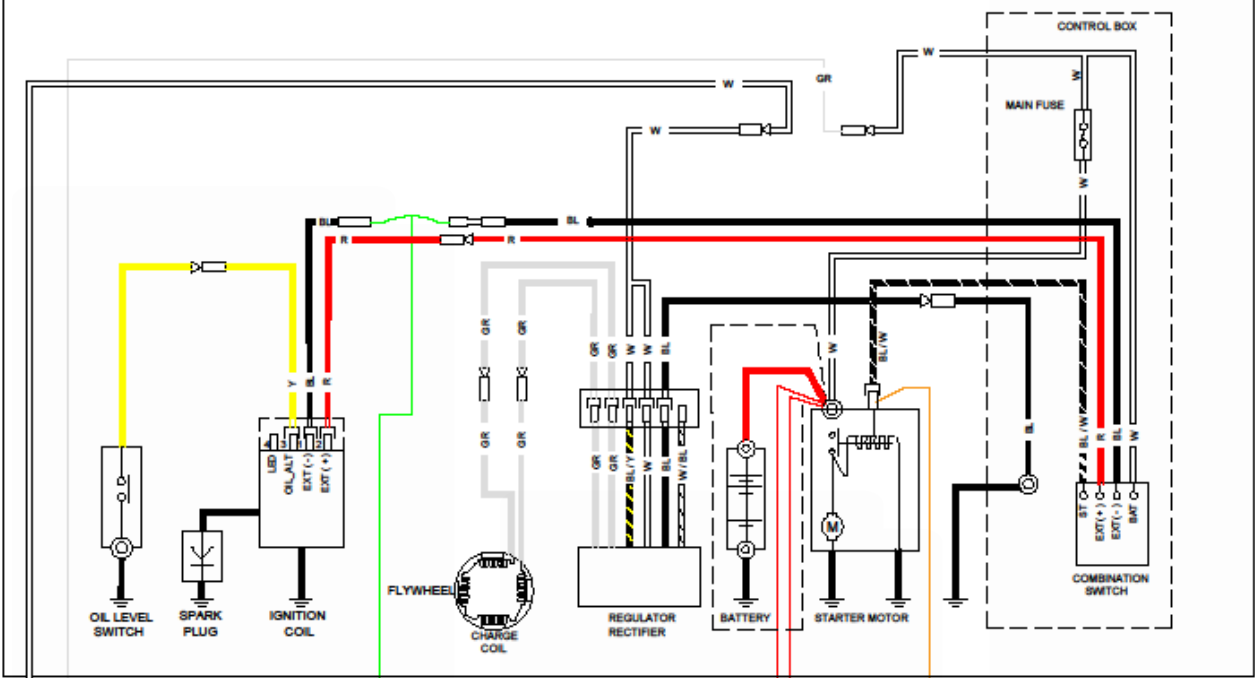

#20

- 1 - RED / ROUGE
- 2 - BLACK / NOIR
- 3 - GREEN / VERT
- 4 - ORANGE / ORANGE

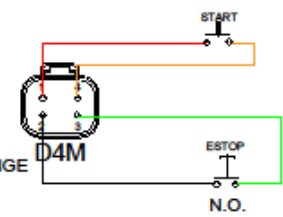

#21

- 1 - WHITE / BLANC
- 2 - GREY / GRIS

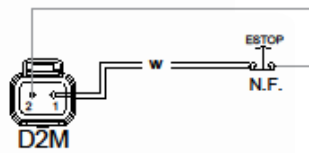

	EXT (+)	EXT (-)	ST	BAT
OFF				
ON	○	○		
START	○	○	○	○

- 1 - WHITE / BLANC
- 2 - GREY / GRIS

#21

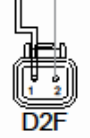

#15

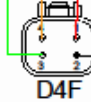

#20

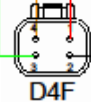

- 1 - RED / ROUGE
- 2 - BLACK / NOIR
- 3 - GREEN / VERT
- 4 - ORANGE / ORANGE

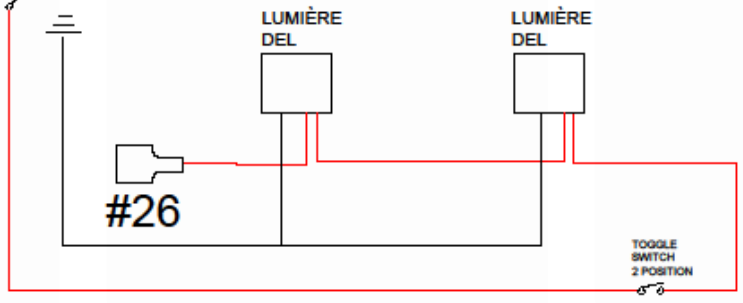

MOTOR ELECTRICAL WIRING / FILAGE ÉLECTRIQUE DU MOTEUR

IFX 20HP

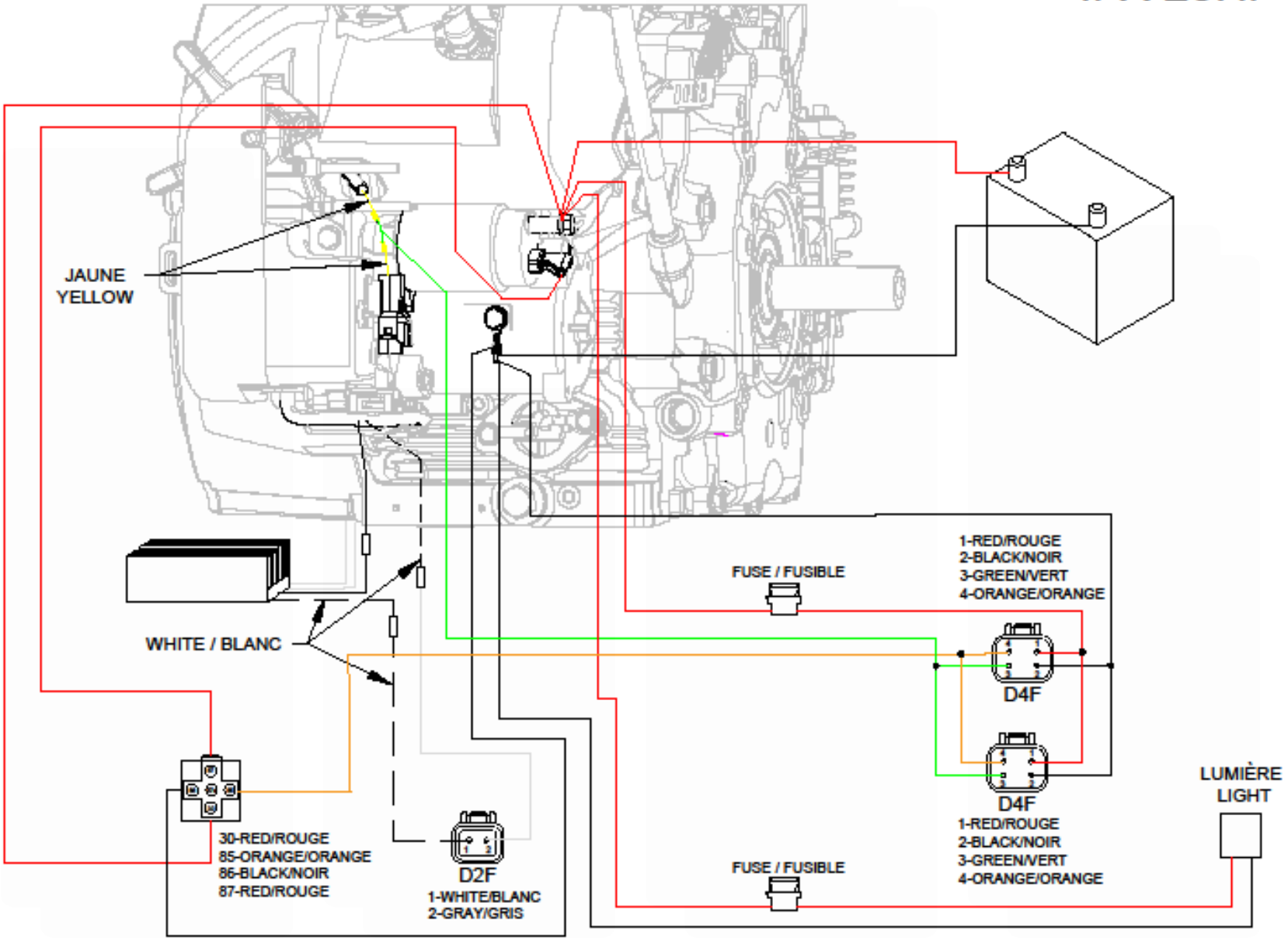





# IFX 20 HP

BL	Black	Gr	Gray
Y	Yellow	Bu	Blue
Bu	Blue		
G	Green	BL/Y	Black / Yellow
R	Red	BL/W	Black / White
W	White	W/Bu	White / Blue

COMBINATION SWITCH				
IGN	GND	BAT	LO	ST
OFF				
ON				
ST				

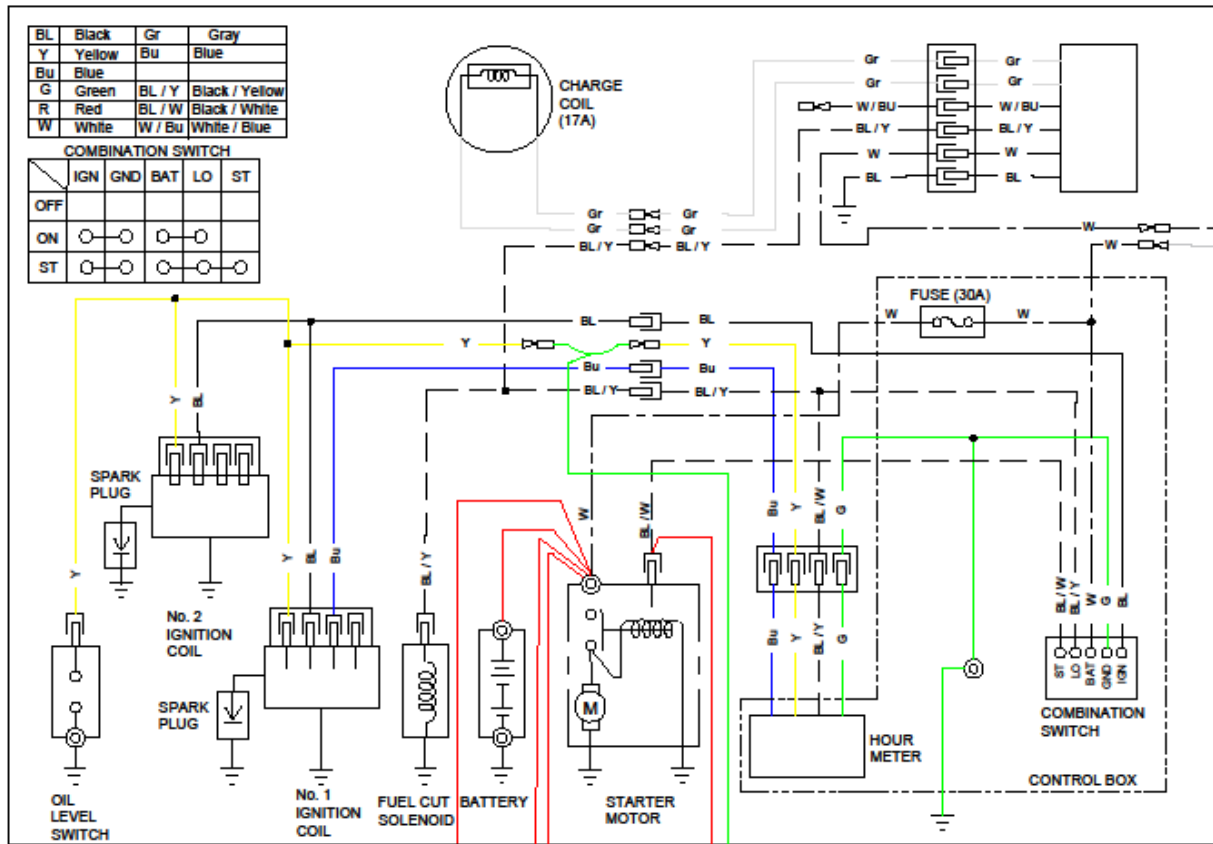

## #20

- 1 - RED / ROUGE
- 2 - BLACK / NOIR
- 3 - GREEN / VERT
- 4 - ORANGE / ORANGE

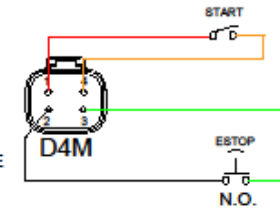

## #21

- 1 - WHITE / BLANC
- 2 - GREY / GRIS

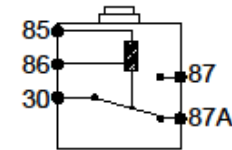
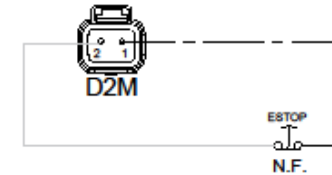

## #21

- 1 - WHITE / BLANC
- 2 - GREY / GRIS



## #26

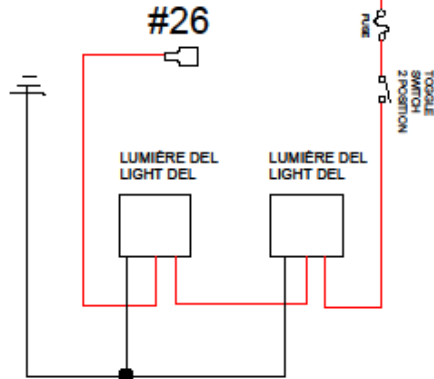

## #15

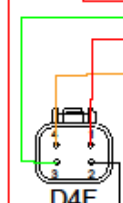

## #20

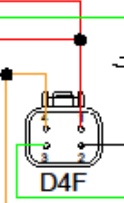

- 1:RED / ROUGE
- 2:BLACK / NOIR
- 3:GREENN / VERT
- 4:ORANGE / ORANGE

