



# MERGEPRO 915/1060

2023

Electric Diagram / Diagramme Électrique

To navigate the electric diagram, you can click on the **red rectangle** that identify the wiring section you want to look up, click on the



button to go back to the main section.

Pour naviguer dans le schéma électrique, vous pouvez cliquer sur les **rectangles rouges** qui identifie la section du câblage que vous souhaitez regarder, cliquez sur le bouton



pour revenir à la section principale.

# DIAGRAMME ÉLECTRIQUE/ELECTRIC DIAGRAM – MERGEPRO 915/1060 (2023)

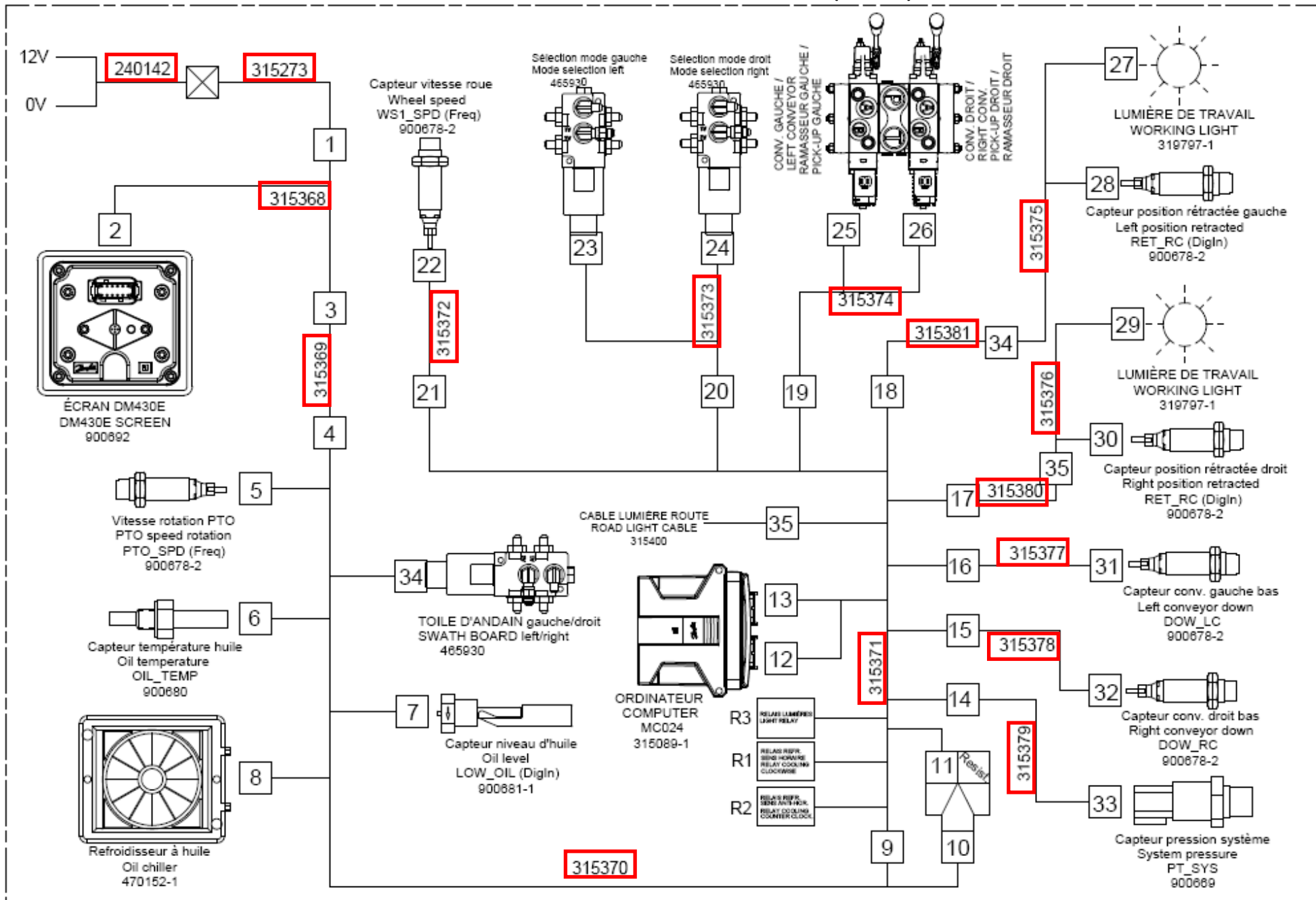

240142

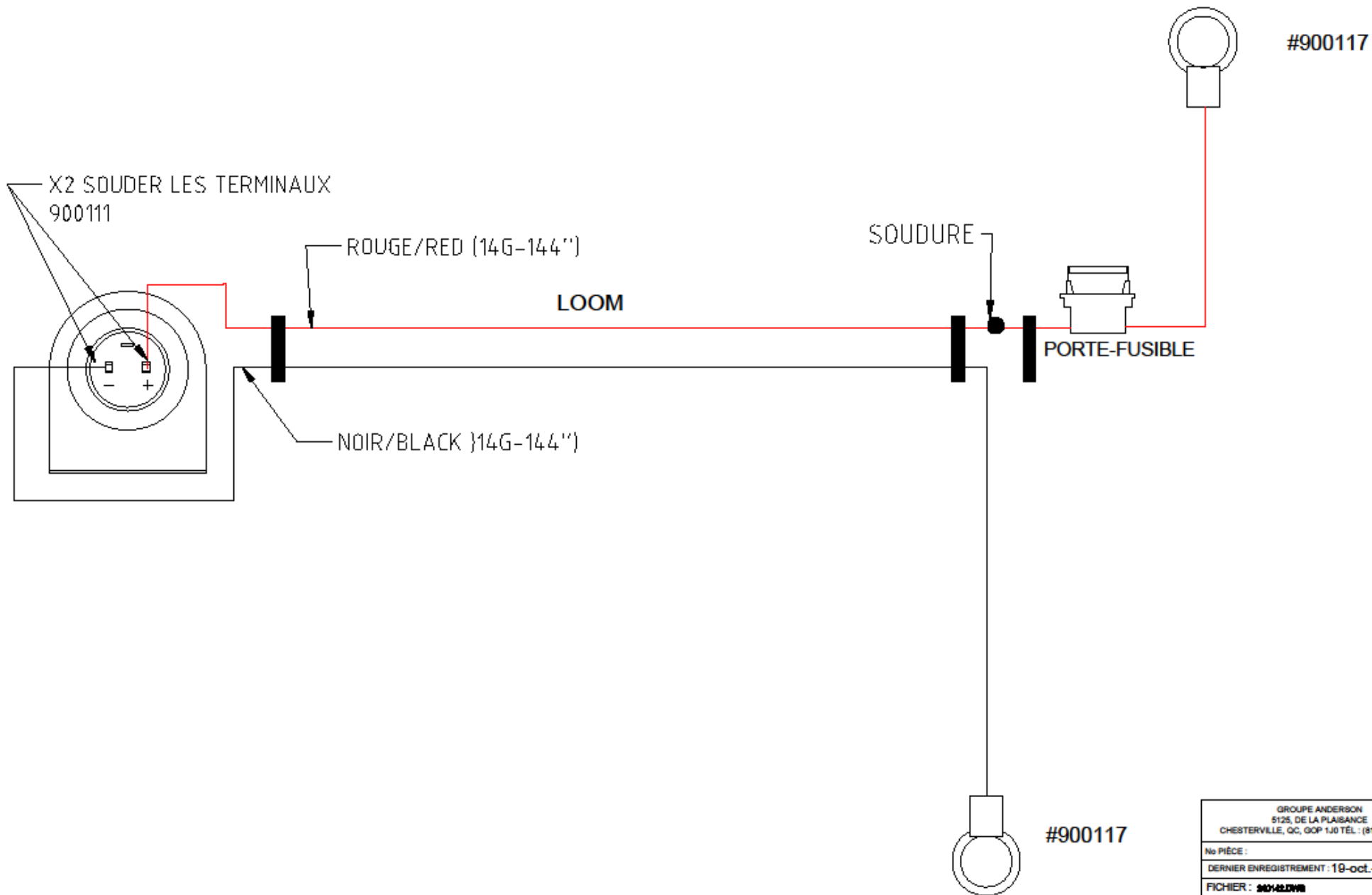

GRUPE ANDERSON 5125, DE LA PLAISANCE CHESTERVILLE, QC, GOP 1J0 TEL : (819) 382-2952
No PIÈCE :
DERNIER ENREGISTREMENT : 19-oct.-23
FICHER : 240142.DWG

315273

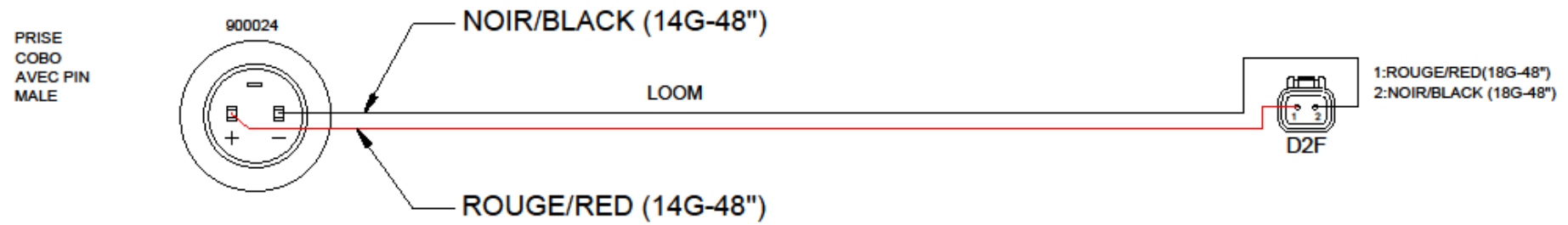

GRUPE ANDERSON 5125, DE LA PLAISANCE CHESTERVILLE, QC, G0P 1J0 TEL : (519) 382-2952
No PIÈCE :
DERNIER ENREGISTREMENT : 31-mars-21
FICHER : 310273.010C

# 315368

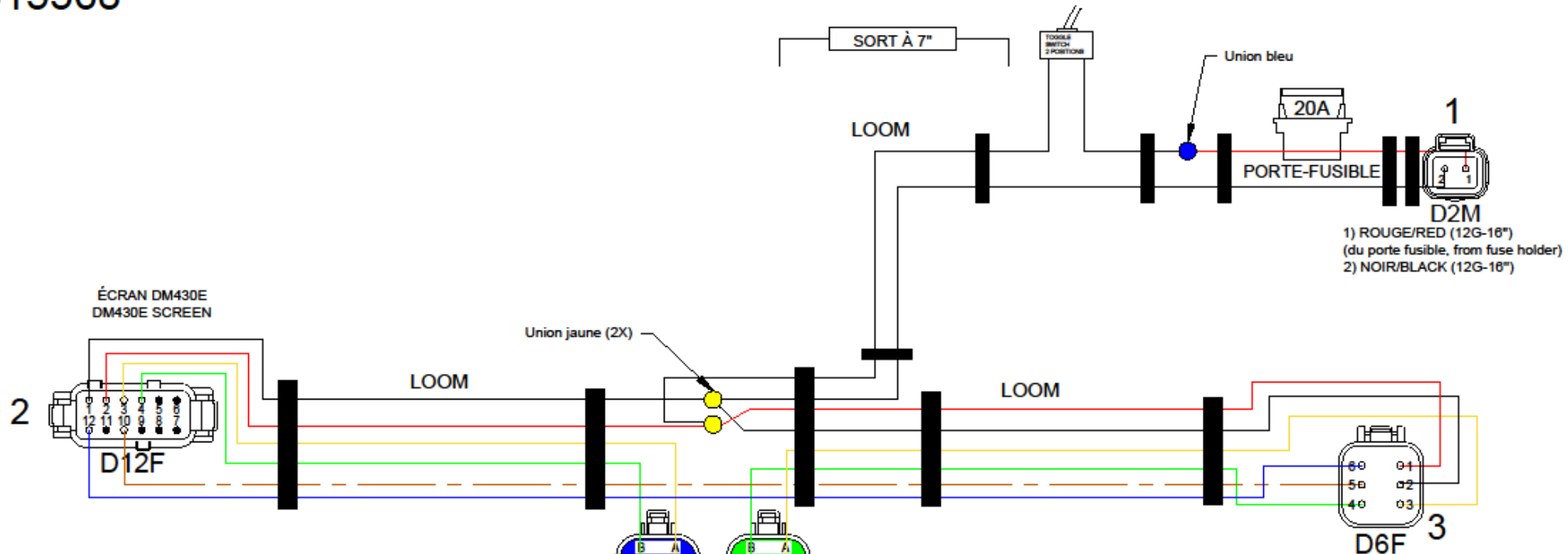

- 1: NOIR/BLACK (18G-8")
- 2: ROUGE/RED (18G-8")
- 3: JAUNE/YELLOW (18G-6.5")
- 4: VERT/GREEN (18G-6.5")
- 5: BOUCHON/PLUG
- 6: BOUCHON/PLUG
- 7: BOUCHON/PLUG
- 8: BOUCHON/PLUG
- 9: BOUCHON/PLUG
- 10: BRUN-BLANC (18G-24")  
BROWN-WHITE
- 11: BOUCHON/PLUG
- 12: BLEU/BLUE (18G-24")

- A) JAUNE/YELLOW (18G-6 1/2")
- B) VERT/GREEN (18G-6 1/2")
- C) BOUCHON/PLUG

- A) JAUNE/YELLOW (18G-16")
- B) VERT/GREEN (18G-16")
- C) BOUCHON/PLUG

- 1: ROUGE/RED (12G-16")
- 2: NOIR/BLACK (12G-16")
- 3: JAUNE/YELLOW (18G-16")
- 4: VERT/GREEN (18G-16")
- 5: BRUN-BLANC (18G-24")  
BROWN-WHITE
- 6: BLEU/BLUE (18G-24")

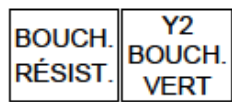
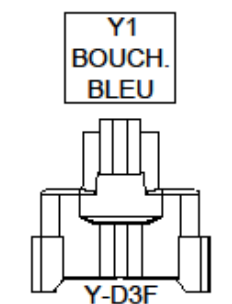

GROUPE ANDERSON  
 5125, DE LA PLAISANCE  
 CHESTERVILLE, QC, GOP 1J0 TÉL. : (514) 382-2952  
 No PIÈCE :  
 DERNIER ENREGISTREMENT : 8-nov.-23  
 FICHER : 200001000

315369

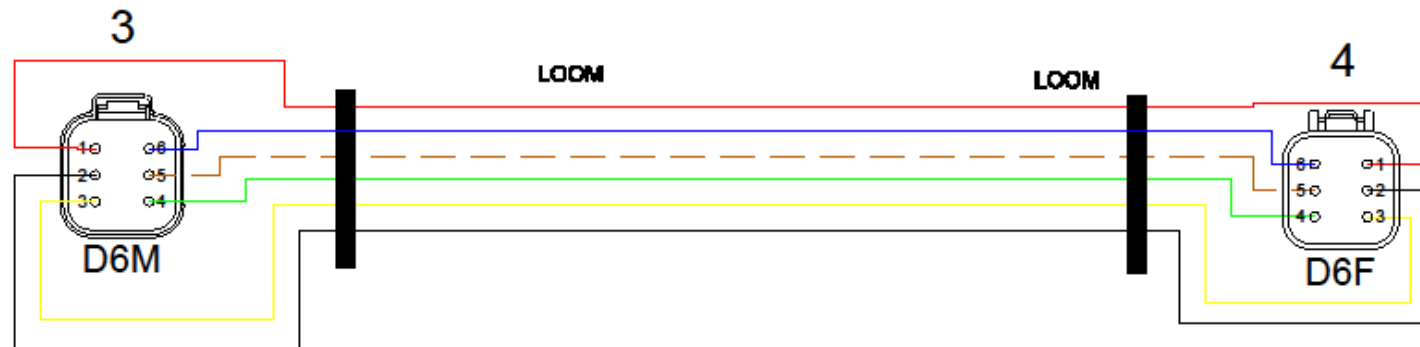

- 1: ROUGE/RED (12G-150")
- 2: NOIR/BLACK (12G-150")
- 3: JAUNE/YELLOW (18G-150")
- 4: VERT/GREEN (18G-150")
- 5: BRUN-BLANC (18G-150")  
BROWN-WHITE
- 6: BLEU/BLUE (18G-150")

- 1: ROUGE/RED (12G-150")
- 2: NOIR/BLACK (12G-150")
- 3: JAUNE/YELLOW (18G-150")
- 4: VERT/GREEN (18G-150")
- 5: BRUN-BLANC (18G-150")  
BROWN-WHITE
- 6: BLEU/BLUE (18G-150")

# 315370



**SORT À 23°**  
CAPTEUR VITESSE PTO  
PTO SPEED SENSOR

**SORT À 80°**  
VALVE BUTÉE CONVOYEUR  
CONVEYOR STOPPER VALVE

- A: ROUGE/RED (18G-89")
- B: NOIR/BLACK (18G-89")
- C: BRUN/BROWN (18G-92")

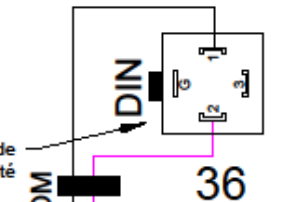
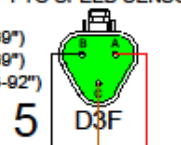

- 1: NOIR/BLACK (18G-10")
- 2: ROSE/PINK (18G-148")

10

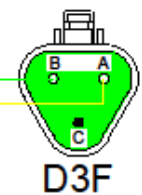

- A: JAUNE/YELLOW (18G-218")
- B: VERT/GREEN (18G-218")
- C: BOUCHON/PLUG

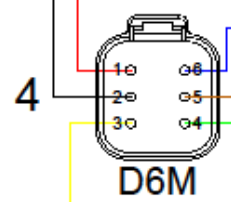

- 1: ROUGE/RED (12G-218")
- 2: NOIR/BLACK (12G-218")
- 3: JAUNE/YELLOW (18G-218")
- 4: VERT/GREEN (18G-218")
- 5: BRUN/BROWN (18G-92")
- 6: BLEU/BLUE (18G-218")

Fil entre de ce côté

36

LOOM

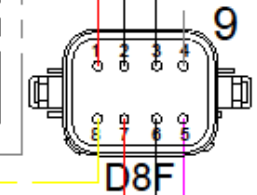

- 1: ROUGE/RED (12G-218")
- 2: NOIR/BLACK (12G-218")
- 3: NOIR-BLANC (18G-114")  
BLACK-WHITE
- 4: GRIS-BLANC (18G-114")  
GREY-WHITE
- 5: ROSE/PINK (18G-148")
- 6: NOIR / BLACK (12G-122")
- 7: ROUGE / RED (12G-122")
- 8: JAUNE-WHITE (18G-114")  
YELLOW-WHITE

LOOM

LOOM

LOOM



6

- 1: NOIR-BLANC (18G-114")  
BLACK-WHITE
- 2: GRIS-BLANC (18G-114")  
GREY-WHITE



7

- A: BOUCHON-PLUG
- B: ROUGE/RED (18G-8")
- C: JAUNE-BLANC (18G-114")  
YELLOW-WHITE



8

- 1: ROUGE/RED (12G-122")
- 2: NOIR/BLACK (12G-122")

CAPTEUR TEMPÉRATURE HUILE  
OIL TEMPERATURE SENSOR

CAPTEUR NIVEAU HUILE  
OIL LEVEL SENSOR

REFROIDISSEUR HUILE  
OIL CHILLER

38



BOUCHON  
4 POLE MALE  
G00032-1

- 1: ROUGE/RED (18G-8")
- 2: NOIR/BLACK (18G-8")
- 3: BLEU/BLUE (18G-218")
- 4: BOUCHON/PLUG

SORTENT À 112°

GRUPE ANDERSON  
5125, DE LA PLAISANCE  
CHESTERTVILLE, QC, G0P 1J0 TEL : (819) 382-2952

No PIÈCE :

DERNIER ENREGISTREMENT : 28-nov.-23

FICHER : 200201000

# 315371

- 1: NOIR/BLACK (18G-11")
- 2: ROUGE/RED (18G-11")
- 3: JAUNE/YELLOW (18G-18")
- 4: VERT/GREEN (18G-18")
- 5: BLEU-BLANC (18G-18")
- 6: BLANC/WHITE (18G-18")
- 7: GRIS/GREY (18G-18")
- 8: ROUGE-BLANC (18G-18")
- 9: RED-WHITE
- 10: NOIR-BLANC (18G-18")
- 11: VERT-BLANC (18G-18")
- 12: JAUNE-BLANC (18G-18")
- 13: BLACK-WHITE
- 14: GREEN-WHITE
- 15: ROSE/PINK (18G-18")
- 16: YELLOW-WHITE

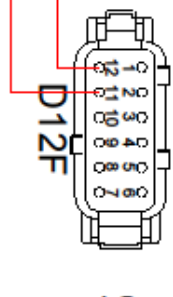
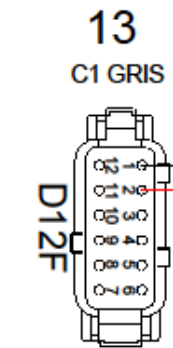

- 1: BLEU/BLUE (18G-18")
- 2: GRIS-BLANC (18G-15")
- 3: GREY-WHITE
- 4: VERT/GREEN (18G-18")
- 5: MAUVE-BLANC (18G-18")
- 6: PURPLE-WHITE
- 7: ROSE/PINK (18G-18")
- 8: BRUN/BROWN (18G-18")
- 9: BLEU-BLANC (18G-18")
- 10: ORANGE-BLANC (18G-15")
- 11: ORANGE (18G-15")
- 12: PINK-WHITE
- 13: ROUGE/RED (18G-11")
- 14: ROUGE/RED (18G-11")

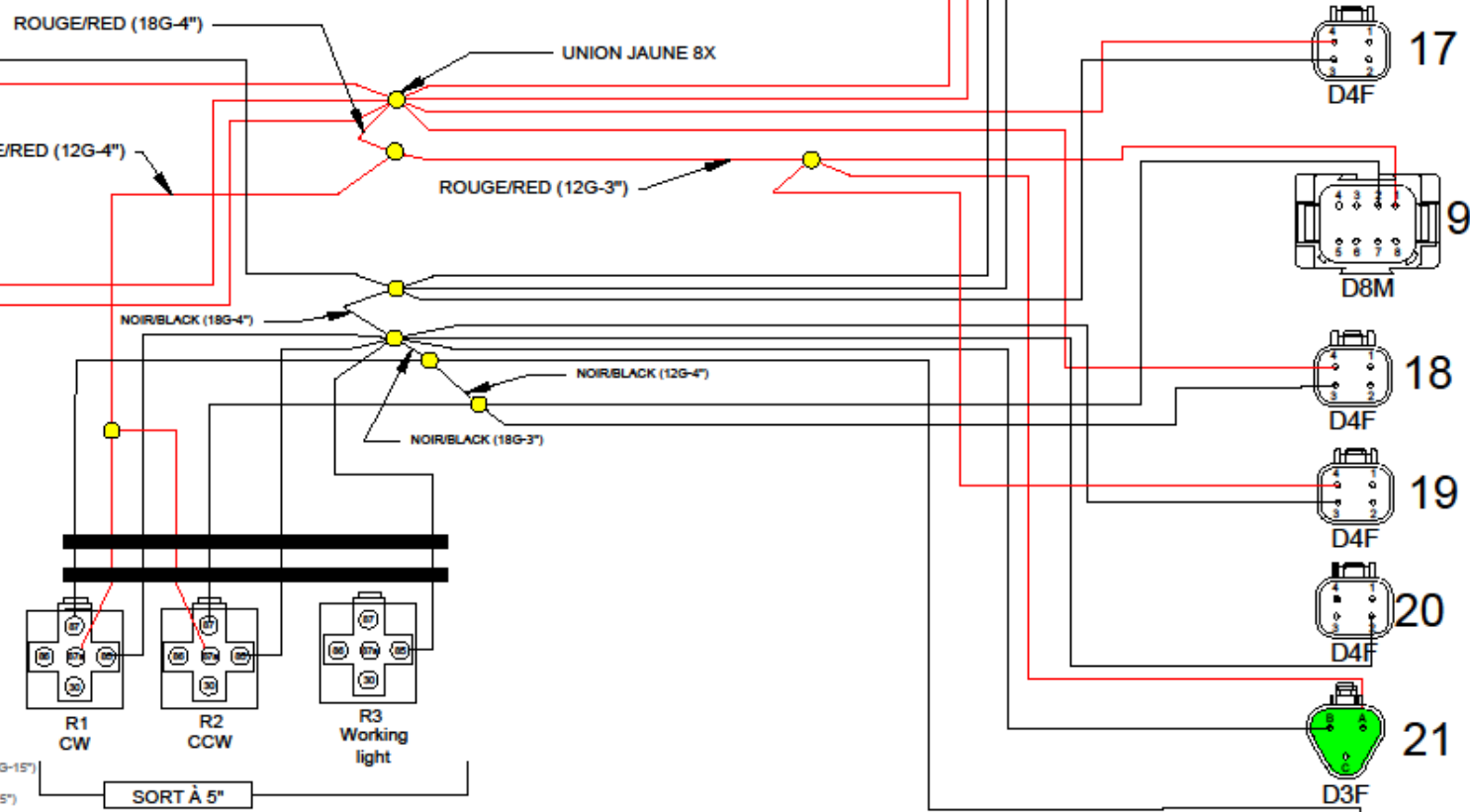

**R1**

- 85: NOIR/BLACK (18G-14")
- 86: ROSE-BLANC (18G-15")
- ORANGE-WHITE
- 30: NOIR/BLACK (12G-18")
- 87: NOIR/BLACK (12G-9")
- 87a: ROUGE/RED (12G-9")

**R2**

- 85: NOIR/BLACK (18G-14")
- 86: ROSE-BLANC (18G-15")
- PINK-WHITE
- 30: ROUGE/RED (12G-18")
- 87: NOIR/BLACK (12G-9")
- 87a: ROUGE/RED (12G-9")

**R3**

- 85: NOIR/BLACK (18G-14")
- 86: ORANGE (18G-15")
- 30: BRUN/BROWN (18G-25")
- 87: BRUN-BLANC (18G-25")
- BROWN-WHITE
- 87a: NA

- A: ROUGE/RED (18G-7")
- B: NOIR/BLACK (18G-7")
- C: BLEU/BLUE (18G-18")

- A: ROUGE/RED (18G-7")
- B: NOIR/BLACK (18G-7")
- C: ROSE/PURPLE (18G-18")

- 1: GRIS/GREY (18G-18")
- 2: BRUN-BLANC (18G-25")
- BROWN-WHITE
- 3: NOIR/BLACK (18G-7")
- 4: ROUGE/RED (18G-7")

- 1: ROUGE/RED (12G-4.5")
- 2: NOIR/BLACK (12G-7")
- 3: NOIR-BLANC (18G-9")
- BLACK-WHITE
- 4: GRIS-BLANC (18G-18")
- GREY-WHITE
- 5: ROSE/PINK (18G-18")
- 6: NOIR/BLACK (12G-18")
- 7: ROUGE/RED (12G-18")
- 8: JAUNE-BLANC (18G-18")
- YELLOW-WHITE

- 1: BLANC/WHITE (18G-18")
- 2: BRUN-BLANC (18G-25")
- BROWN-WHITE
- 3: NOIR/BLACK (18G-7")
- 4: ROUGE/RED (18G-4.5")

- 1: VERT/GREEN (18G-18")
- 2: MAUVE-BLANC (18G-18")
- PURPLE-WHITE
- 3: NOIR/BLACK (18G-7")
- 4: ROUGE/RED (18G-7")

- 1: BRUN/BROWN (18G-18")
- 2: NOIR/BLACK (18G-7")
- 3: BLEU-BLANC (18G-18")
- BLUE-WHITE
- 4: BOUCHON/PLUG

- A: ROUGE/RED (18G-7")
- B: NOIR/BLACK (18G-7")
- C: VERT-BLANC (18G-18")
- GREEN-WHITE

- 1: NOIR/BLACK (18G-7")
- 2: BRUN/BROWN (18G-25")

GROUPE ANDERSSON  
 5125, DE LA PLAISANCE  
 CHESTERTVILLE, QC, G0P 1J0 TÉL. : (819) 382-2952  
 No PIÈCE :  
 DERNIER ENREGISTREMENT : 12-juil.-23  
 FICHER : 2023\_P1.DWG





# 315371



- 1: NOIR/BLACK (18G-11")
- 2: ROUGE/RED (18G-11")
- 3: JAUNE/YELLOW (18G-18")
- 4: VERT/GREEN (18G-18")
- 5: BLEU-BLANC (18G-18")
- 6: BLANC/WHITE (18G-18")
- 7: GRIS/GREY (18G-18")
- 8: ROUGE-BLANC (18G-18")
- 9: NOIR-BLANC (18G-18")
- 10: VERT-BLANC (18G-18")
- 11: ROSE/PINK (18G-18")
- 12: JAUNE-BLANC (18G-18")

- 1: ROUGE/RED (12G-4.5")
- 2: NOIR/BLACK (12G-7")
- 3: NOIR-BLANC (18G-9")
- 4: GRIS-BLANC (18G-18")
- 5: ROSE/PINK (18G-18")
- 6: NOIR/BLACK (12G-18")
- 7: ROUGE/RED (12G-18")
- 8: JAUNE-BLANC (18G-18")

- A: JAUNE/YELLOW (18G-18")
- B: VERT/GREEN (18G-18")
- C: BOUCHON/PLUG

- 1: NOIR-BLANC (18G-18")
- 2: BLACK-WHITE
- 3: ROUGE-BLANC (18G-18")
- 4: RED-WHITE
- 5: BOUCHON/PLUG
- 6: BLEU-BLANC (18G-18")
- 7: BLUE-WHITE

13  
C1 GRIS

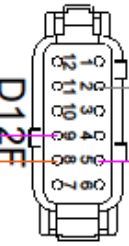
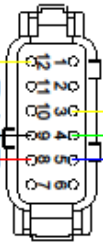

12  
C2 NOIR

- 1: BLEU/BLUE (18G-18")
- 2: GRIS-BLANC (18G-18")
- 3: VERT/GREEN (18G-18")
- 4: MAUVE-BLANC (18G-18")
- 5: ROSE/PINK (18G-18")
- 6: BRUN/BROWN (18G-18")
- 7: BLEU-BLANC (18G-18")
- 8: ORANGE-BLANC (18G-15")
- 9: ROSE-BLANC (18G-15")
- 10: ORANGE (18G-19")
- 11: ROUGE/RED (18G-11")
- 12: ROUGE/RED (18G-11")

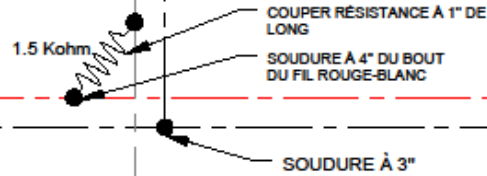

1.5 Kohm

SOUDURE À 3"

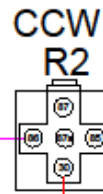
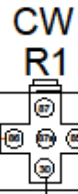
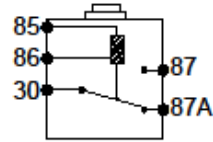

SORT À 5"

R1

- 85: NOIR/BLACK (18G-14")
- 86: ORANGE-BLANC (18G-15")
- 30: NOIR/BLACK (12G-18")
- 87: NOIR/BLACK (12G-9")
- 87a: ROUGE/RED (12G-9")

R2

- 85: NOIR/BLACK (18G-14")
- 86: ROSE-BLANC (18G-15")
- 30: ROUGE/RED (12G-18")
- 87: NOIR/BLACK (12G-9")
- 87a: ROUGE/RED (12G-9")

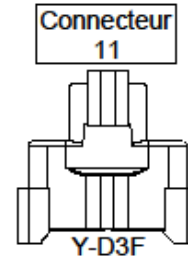

RÉSIST.

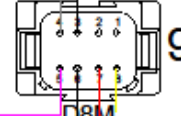

GROUPE ANDERSON 5125, DE LA PLAISANCE CHESTERTVILLE, QC, G0P 1J0 TÉL. : (819) 382-2952	
No PIÈCE :	
DERNIER ENREGISTREMENT : 12-juil.-23	
FICHER : 2007_P2DWH	

# 315371



- 1: NOIR/BLACK (18G-11")
- 2: ROUGE/RED (18G-11")
- 3: JAUNE/YELLOW (18G-18")
- 4: VERT/GREEN (18G-18")
- 5: BLEU-BLANC (18G-18")  
BLUE-WHITE
- 6: BLANC/WHITE (18G-18")
- 7: GRIS/GREY (18G-18")
- 8: ROUGE-BLANC (18G-18")  
RED-WHITE
- 9: NOIR-BLANC (18G-18")  
BLACK-WHITE
- 10: VERT-BLANC (18G-18")  
GREEN-WHITE
- 11: ROSE/PINK (18G-18")
- 12: JAUNE-BLANC (18G-18")  
YELLOW-WHITE

13

C1 GRIS

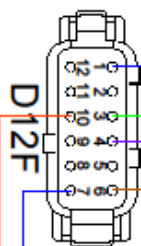
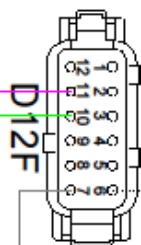

12

C2 NOIR

- 1: BLEU/BLUE (18G-18")
- 2: GRIS-BLANC (18G-18")  
GREY-WHITE
- 3: VERT/GREEN (18G-18")
- 4: MAUVE-BLANC (18G-18")  
PURPLE-WHITE
- 5: ROSE/PINK (18G-18")
- 6: BRUN/BROWN (18G-18")
- 7: BLEU-BLANC (18G-18")  
BLUE-WHITE
- 8: ORANGE-BLANC (18G-15")  
ORANGE-WHITE
- 9: ROSE-BLANC (18G-15")  
PINK-WHITE
- 10: ORANGE (18G-15")
- 11: ROUGE/RED (18G-11")
- 12: ROUGE/RED (18G-11")

R3

- 85: NOIR/BLACK (18G-14")
- 86: ORANGE (18G-15")
- 88: BRUN/BROWN (18G-17")
- 87: BRUN-BLANC (18G-18")  
BROWN-WHITE
- 87a: NA

R3  
Working  
light

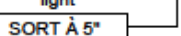

SOUDURE À 7"

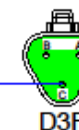

15

- A: ROUGE/RED (18G-7")
- B: NOIR/BLACK (18G-7")
- C: BLEU/BLUE (18G-18")



16

- A: ROUGE/RED (18G-7")
- B: NOIR/BLACK (18G-7")
- C: ROSE/PURPLE (18G-18")



17

- 1: GRIS/GREY (18G-18")
- 2: BRUN-BLANC (18G-25")  
BROWN-WHITE
- 3: NOIR/BLACK (18G-7")
- 4: ROUGE/RED (18G-7")



18

- 1: BLANC/WHITE (18G-18")
- 2: BRUN-BLANC (18G-25")  
BROWN-WHITE
- 3: NOIR/BLACK (18G-7")
- 4: ROUGE/RED (18G-4.5")

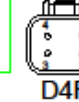

19

- 1: VERT/GREEN (18G-18")
- 2: MAUVE-BLANC (18G-18")  
PURPLE-WHITE
- 3: NOIR/BLACK (18G-7")
- 4: ROUGE/RED (18G-7")



20

- 1: BRUN/BROWN (18G-18")
- 2: NOIR/BLACK (18G-7")
- 3: BLEU-BLANC (18G-18")  
BLUE-WHITE
- 4: BOUCHON/PLUG



21

- A: ROUGE/RED (18G-7")
- B: NOIR/BLACK (18G-7")
- C: VERT-BLANC (18G-18")  
GREEN-WHITE



35

- 1: NOIR/BLACK (18G-7")
- 2: BRUN/BROWN (18G-25")

GRUPE ANDERSON  
5125, DE LA PLAISANCE  
CHESTERTVILLE, QC, G0P 1J0 TEL: (819) 382-2952  
No PIÈCE :  
DERNIER ENREGISTREMENT : 12-juil.-23  
FICHER : 2023\_P1234

315372

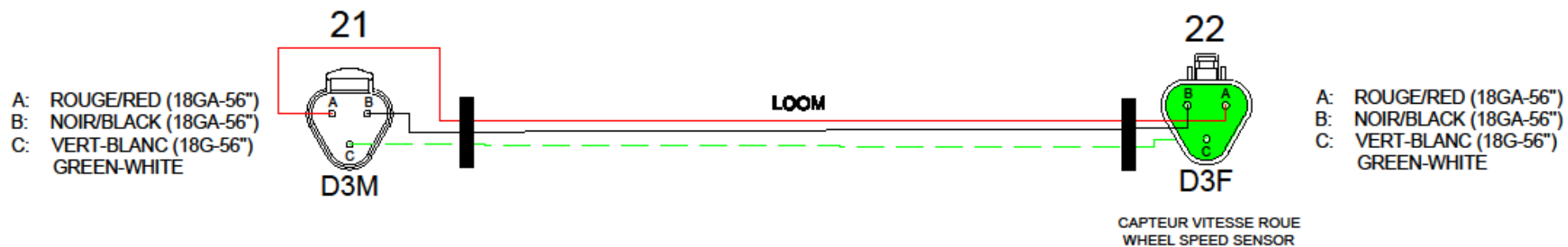

GRUPE ANDERSON 5125, DE LA PLAISANCE CHESTERVILLE, QC, G0P 1J0 TEL : (819) 382-2952
No PIÈCE :
DERNIER ENREGISTREMENT : 9-janv.-23
FICHER : 2002.0908

315373

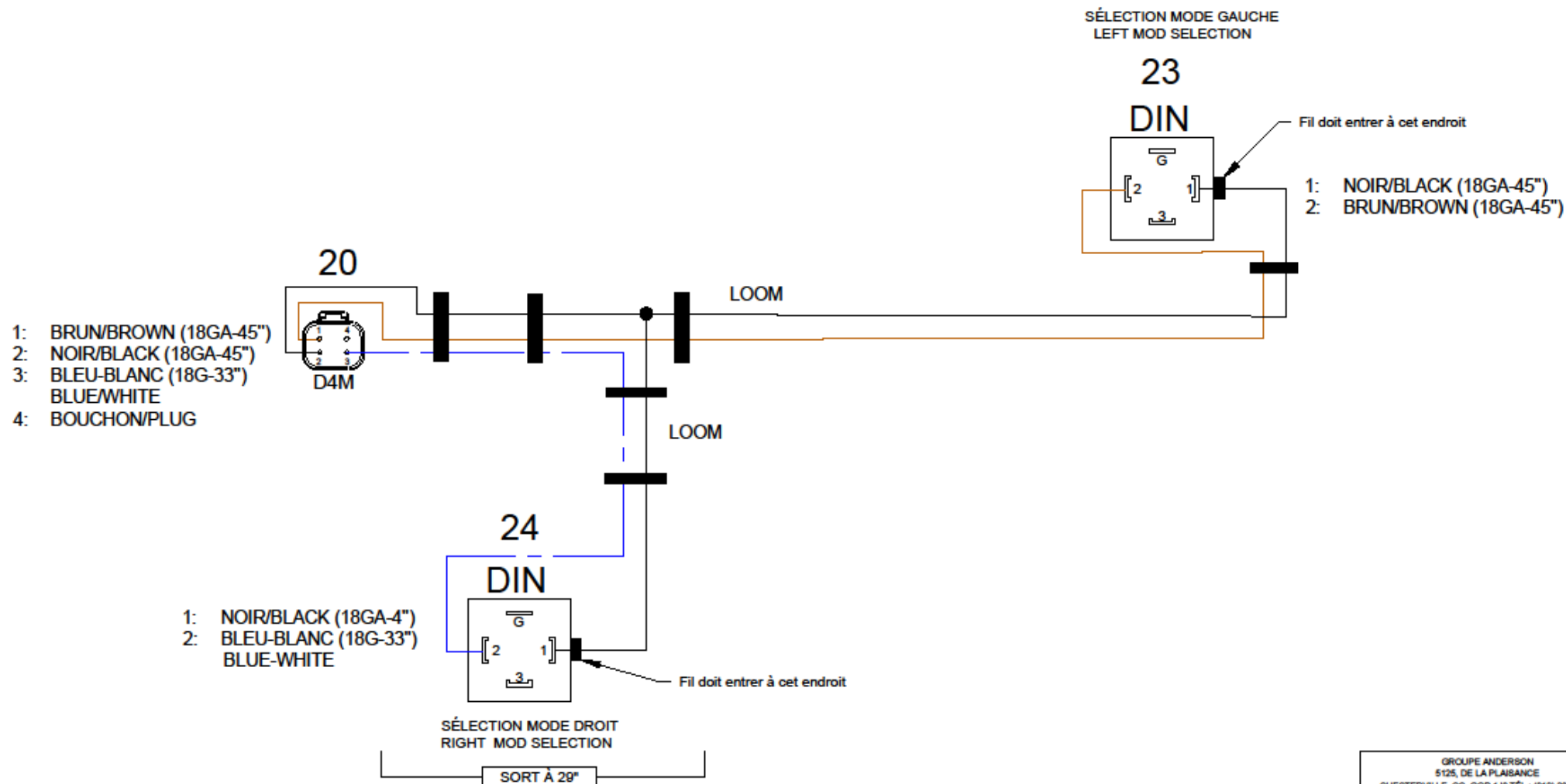

GRUPE ANDERSON 5125, DE LA PLAISANCE CHESTERVILLE, QC, G0P 1J0 TÉL. : (819) 382-2952
No PIÈCE :
DERNIER ENREGISTREMENT : 9-mai-23
FICHER : <b>315373</b>

315374

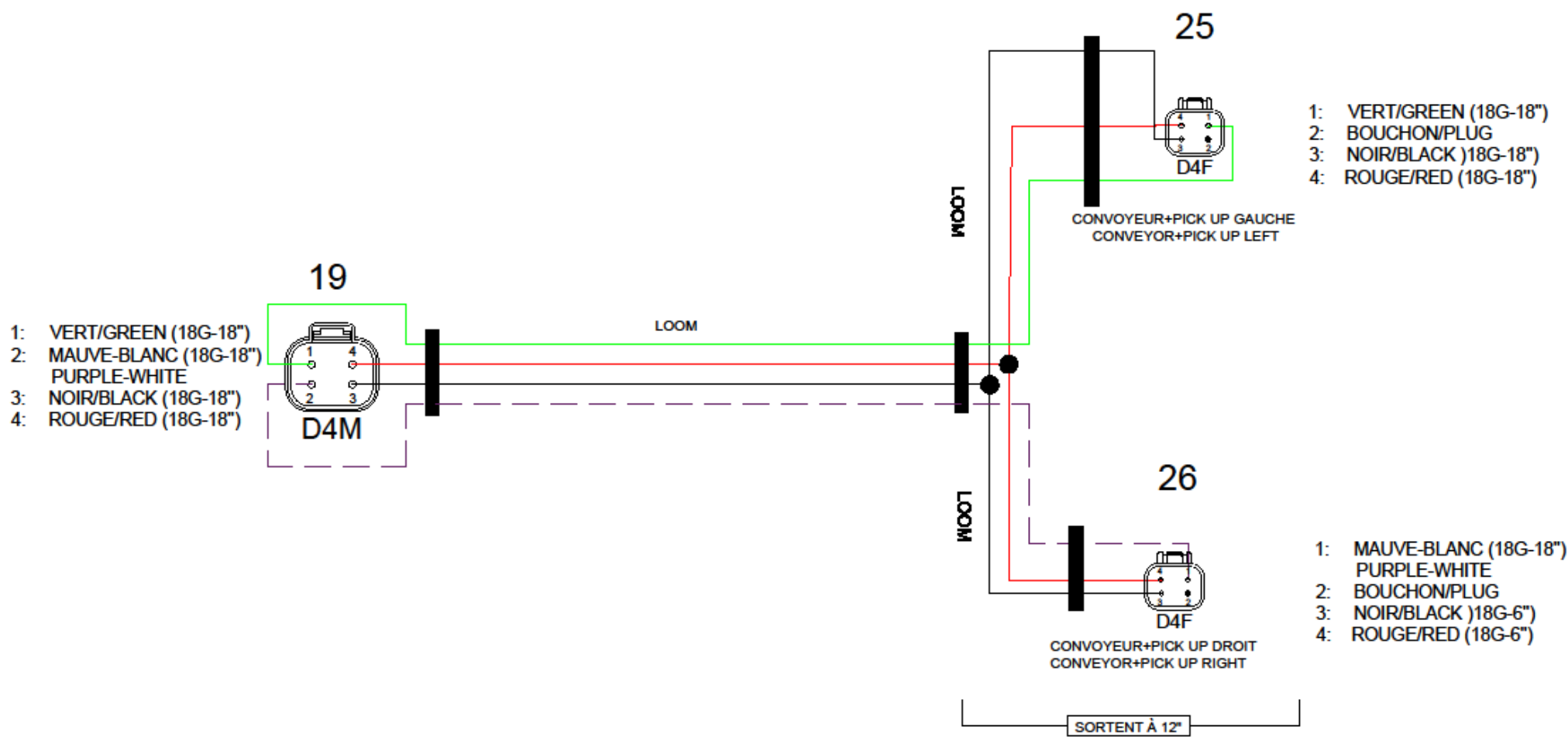

GRUPE ANDERSON 5125, DE LA PLAISANCE CHESTERVILLE, QC, G0P 1J0 TÉL : (819) 382-2952
No PIÈCE :
DERNIER ENREGISTREMENT : 27-nov.-23
FICHER : 20004.DWG

315375

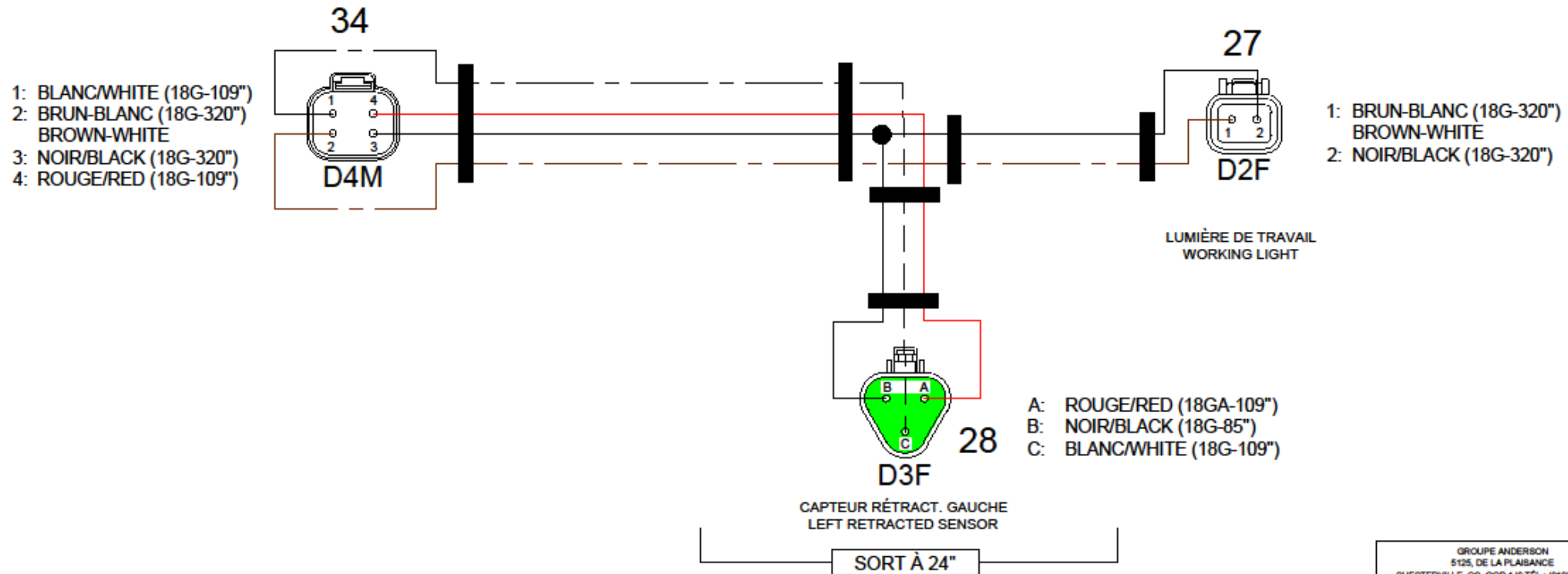

GRUPE ANDERSON 5125, DE LA PLAISANCE CHESTERVILLE, QC, GOP 1J0 TÉL. : (819) 382-2952
No PIÈCE :
DERNIER ENREGISTREMENT : 17-avr.-23
FICHER : <b>315375</b>

315376

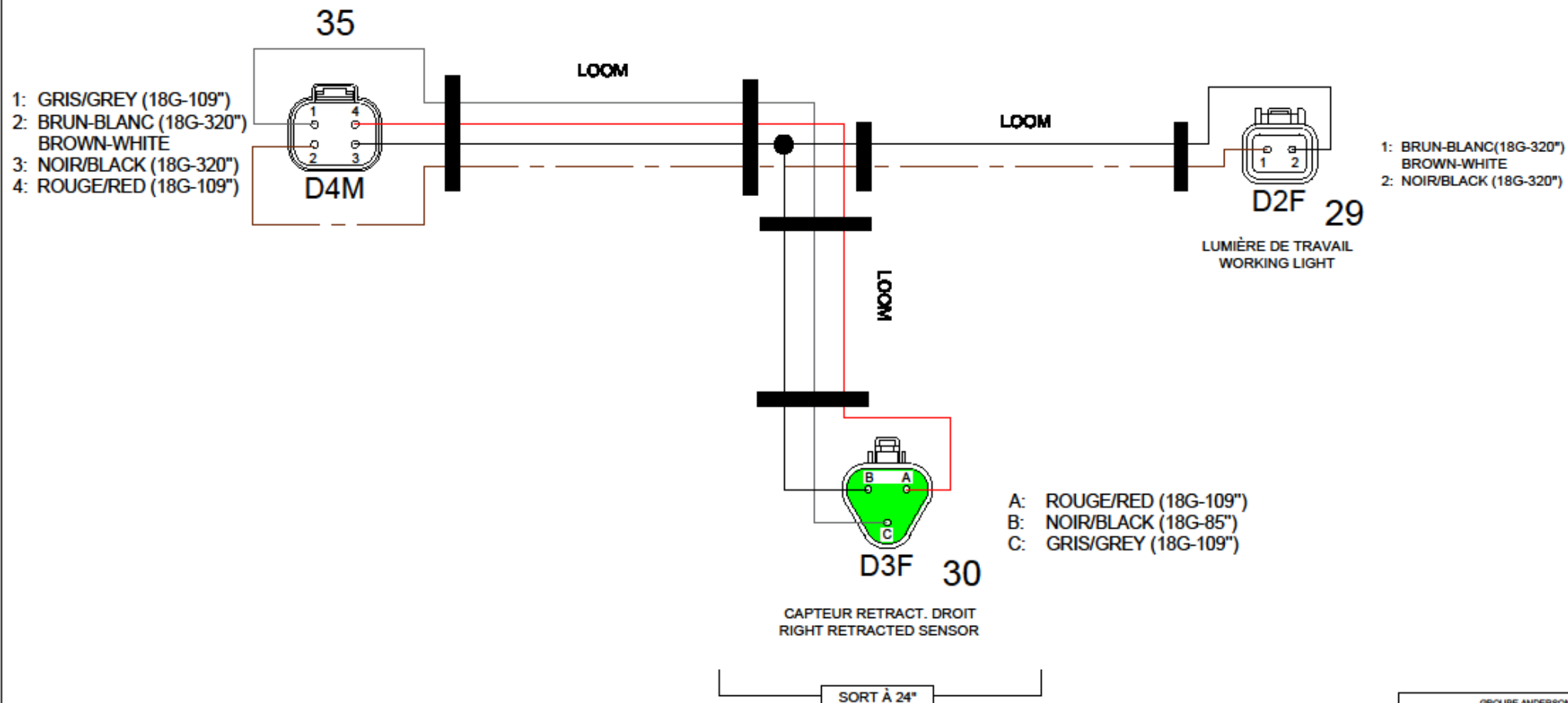

GROUPE ANDERSON 5125, DE LA PLAISANCE CHESTERVILLE, QC, GOP 1J0 TÉL. : (819) 382-2952
No Pièce :
DERNIER ENREGISTREMENT : 17-avr.-23
FICHER : <b>315376</b>

315377

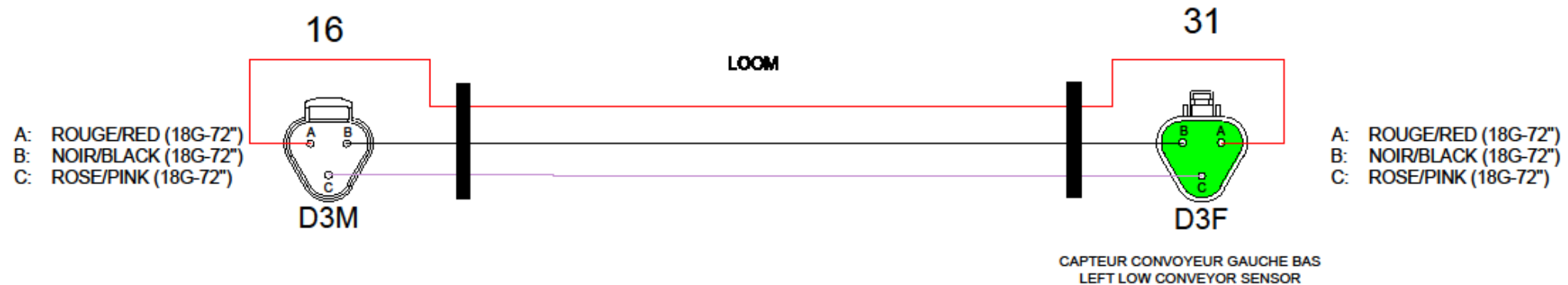

GRUPE ANDERSON 5125, DE LA PLAISANCE CHESTERVILLE, QC, G0P 1J0 TEL : (819) 382-2952
No PIÈCE :
DERNIER ENREGISTREMENT : 9-janv.-23
FICHER : 2007.DRM



315378

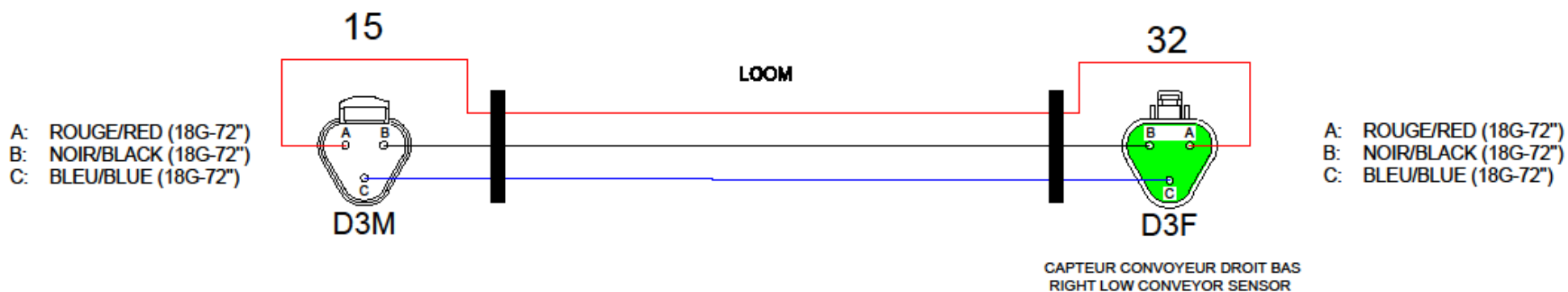

GRUPE ANDERSON 5125, DE LA PLAISANCE CHESTERVILLE, QC, GOP 1J0 T�L : (514) 382-2952
No PI�CE :
DERNIER ENREGISTREMENT : 9-janv.-23
FICHER : 315378

315379

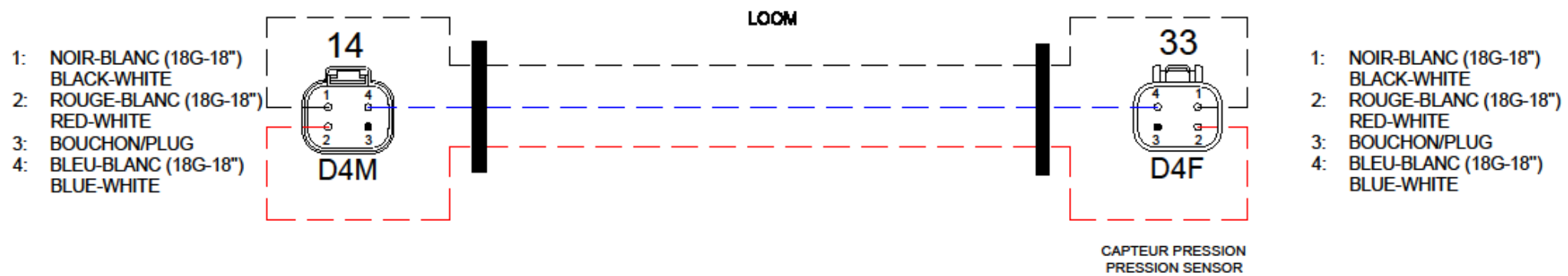

GRUPE ANDERSON 5125, DE LA PLAISANCE CHESTERVILLE, QC, GOP 1J0 TEL : (819) 382-2952
No PIÈCE :
DERNIER ENREGISTREMENT : 9-janv.-23
FICHER : <b>315379.DWG</b>

315380



- 1: GRIS/GREY (18G-86")
- 2: BRUN-BLANC (18G-86")  
BROWN-WHITE
- 3: NOIR/BLACK (18G-86")
- 4: ROUGE/RED (18G-86")

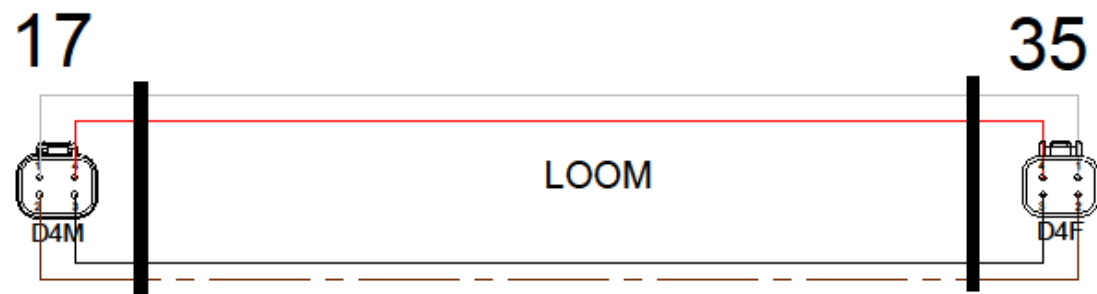

- 1: GRIS/GREY (18G-86")
- 2: BRUN-BLANC (18G-86")  
BROWN-WHITE
- 3: NOIR/BLACK (18G-86")
- 4: ROUGE/RED (18G-86")

GRUPE ANDERSON 5125, DE LA PLAISANCE CHESTERVILLE, QC, G0P 1J0 T�L : (514) 383-2952
No PI�CE :
DERNIER ENREGISTREMENT : 24-janv.-23
FICHER : <b>315380</b>

315381



- 1: BLANC/WHITE (18G-86")
- 2: BRUN-BLANC (18G-86")  
BROWN-WHITE
- 3: NOIR/BLACK (18G-86")
- 4: ROUGE/RED (18G-86")

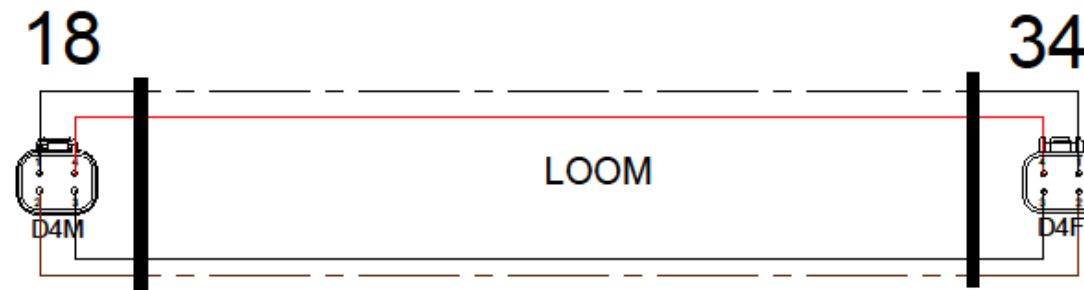

- 1: BLANC/WHITE (18G-86")
- 2: BRUN-BLANC (18G-86")  
BROWN-WHITE
- 3: NOIR/BLACK (18G-86")
- 4: ROUGE/RED (18G-86")

GRUPE ANDERSON 5125, DE LA PLAISANCE CHESTERVILLE, QC, GOP 1J0 TÉL. : (514) 383-2952
No Pièce :
DERNIER ENREGISTREMENT : 24-janv.-23
FICHER : 20001.DWG