



MERGEPRO 915/1060

2024 and +
Electric Diagram / Diagramme Électrique

To navigate the electric diagram, you can click on the **red rectangle** that identify the wiring section you want to look up, click on the

Back

button to go back to the main section.

Pour naviguer dans le schéma électrique, vous pouvez cliquer sur les **rectangles rouges** qui identifie la section du câblage que vous souhaitez regarder, cliquez sur le bouton

Back

pour revenir à la section principale.

DIAGRAMME ÉLECTRIQUE/ELECTRIC DIAGRAM – MERGEPRO 915 1060

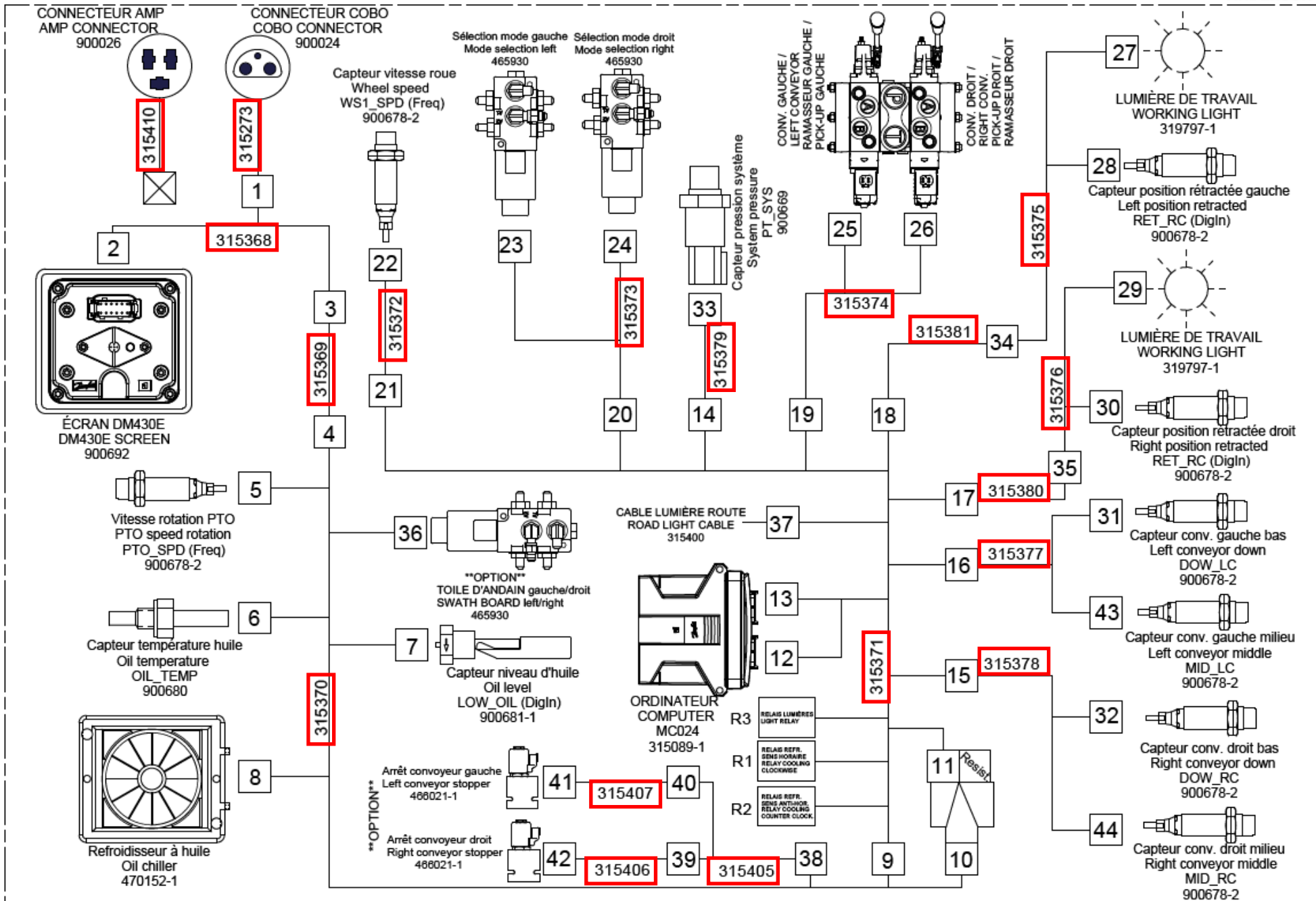

315273

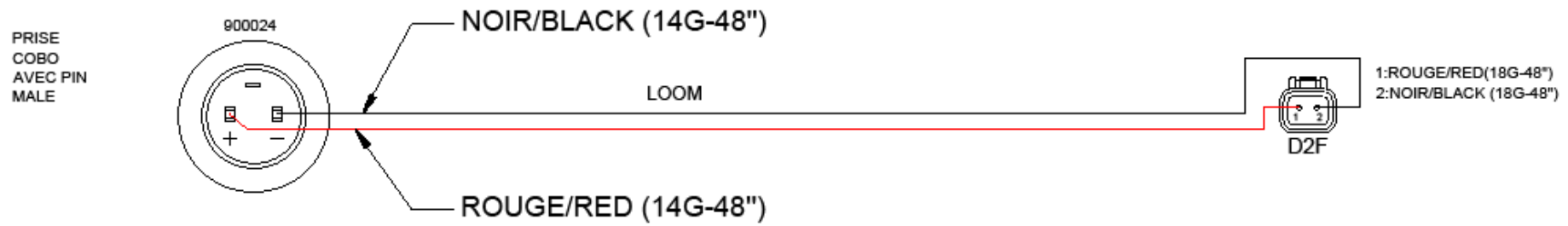

GRUPE ANDERSON 5125, DE LA PLAISANCE CHESTERVILLE, QC, G0P 1J0 TEL : (519) 382-2952
No PIÈCE :
DERNIER ENREGISTREMENT : 31-mars-21
FICHIER : 310273.DWG

315368

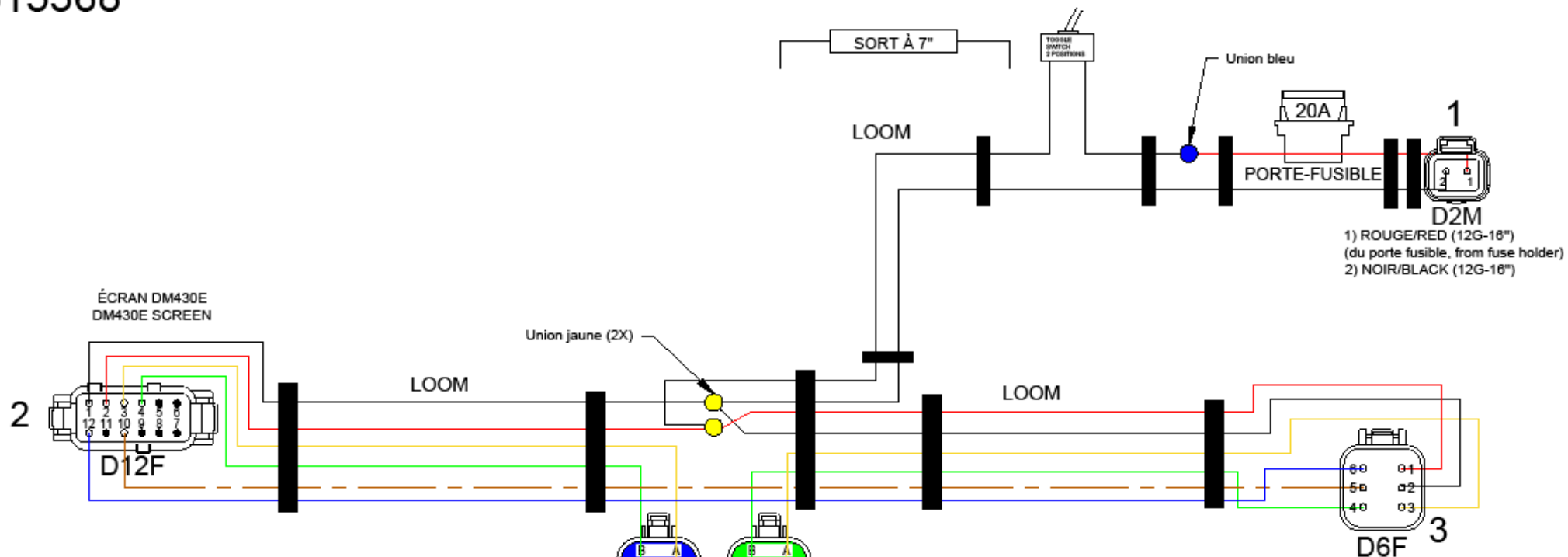

- 1: NOIR/BLACK (18G-8")
- 2: ROUGE/RED (18G-8")
- 3: JAUNE/YELLOW (18G-6.5")
- 4: VERT/GREEN (18G-6.5")
- 5: BOUCHON/PLUG
- 6: BOUCHON/PLUG
- 7: BOUCHON/PLUG
- 8: BOUCHON/PLUG
- 9: BOUCHON/PLUG
- 10: BRUN-BLANC (18G-24")
BROWN-WHITE
- 11: BOUCHON/PLUG
- 12: BLEU/BLUE (18G-24")

- A) JAUNE/YELLOW (18G-6 1/2")
- B) VERT/GREEN (18G-6 1/2")
- C) BOUCHON/PLUG

- A) JAUNE/YELLOW (18G-16")
- B) VERT/GREEN (18G-16")
- C) BOUCHON/PLUG

- 1: ROUGE/RED (12G-16")
- 2: NOIR/BLACK (12G-16")
- 3: JAUNE/YELLOW (18G-16")
- 4: VERT/GREEN (18G-16")
- 5: BRUN-BLANC (18G-24")
BROWN-WHITE
- 6: BLEU/BLUE (18G-24")

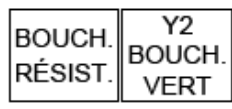
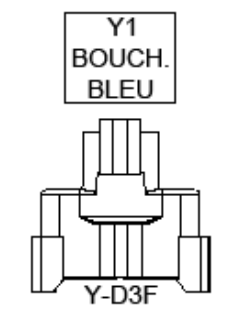
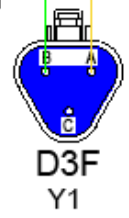

GROUPE ANDERSON
 5125, DE LA PLAISANCE
 CHESTERVILLE, QC, G0P 1J0 TÉL : (819) 382-2952
 No PIÈCE :
 DERNIER ENREGISTREMENT : 8-nov.-23
 FICHER : 200001000

315369

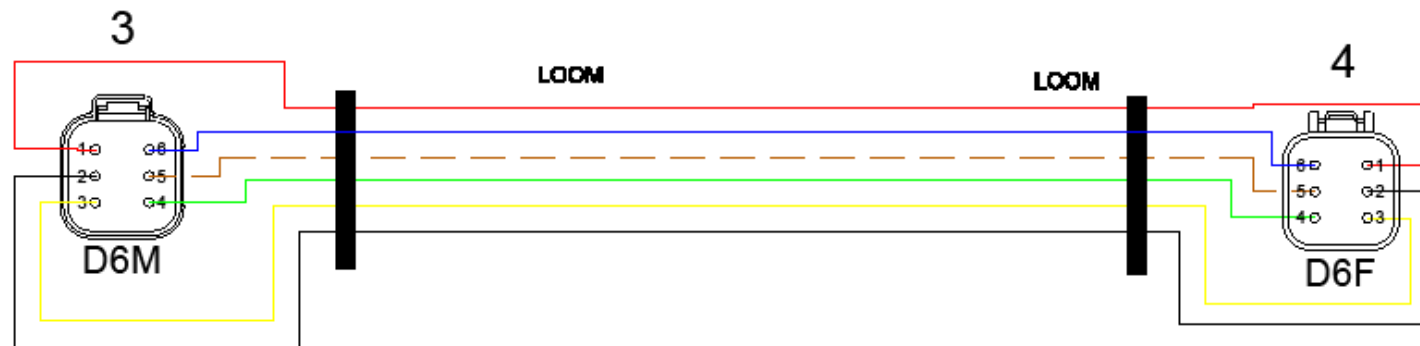

- 1: ROUGE/RED (12G-150")
- 2: NOIR/BLACK (12G-150")
- 3: JAUNE/YELLOW (18G-150")
- 4: VERT/GREEN (18G-150")
- 5: BRUN-BLANC (18G-150")
BROWN-WHITE
- 6: BLEU/BLUE (18G-150")

- 1: ROUGE/RED (12G-150")
- 2: NOIR/BLACK (12G-150")
- 3: JAUNE/YELLOW (18G-150")
- 4: VERT/GREEN (18G-150")
- 5: BRUN-BLANC (18G-150")
BROWN-WHITE
- 6: BLEU/BLUE (18G-150")

GRUPE ANDERSON 5125, DE LA PLAISANCE CHESTERVILLE, QC, G0P 1J0 TEL : (819) 382-2952
No PIÈCE :
DERNIER ENREGISTREMENT : 8-nov.-23
FICHER : 315369.DWG

315370



SORT À 23°
CAPTEUR VITESSE PTO
PTO SPEED SENSOR

SORT À 80°
VALVE BUTÉE CONVOYEUR
CONVEYOR STOPPER VALVE

- A: ROUGE/RED (18G-69")
- B: NOIR/BLACK (18G-69")
- C: BRUN/BROWN (18G-92")

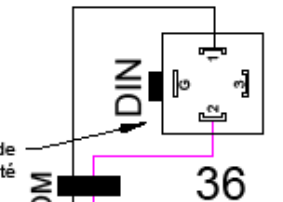
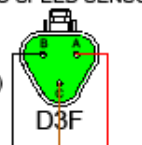

- 1: NOIR/BLACK (18G-10")
- 2: ROSE/PINK (18G-148")

10

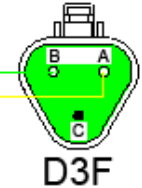

- A: JAUNE/YELLOW (18G-218")
- B: VERT/GREEN (18G-218")
- C: BOUCHON/PLUG

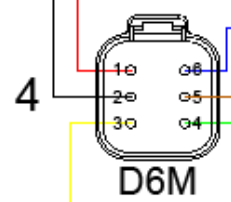

- 1: ROUGE/RED (12G-218")
- 2: NOIR/BLACK (12G-218")
- 3: JAUNE/YELLOW (18G-218")
- 4: VERT/GREEN (18G-218")
- 5: BRUN/BROWN (18G-92")
- 6: BLEU/BLUE (18G-218")

LOOM

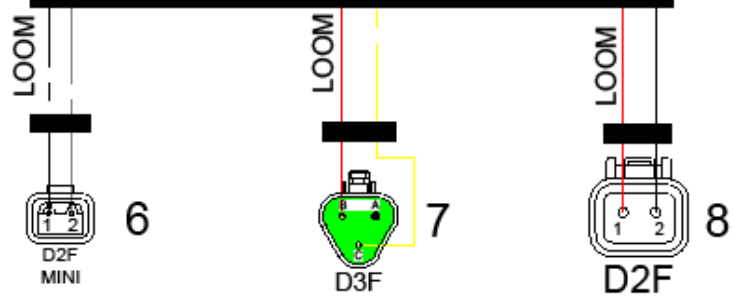

- 1: NOIR-BLANC (18G-114")
BLACK-WHITE
- 2: GRIS-BLANC (18G-114")
GREY-WHITE

- A: BOUCHON-PLUG
- B: ROUGE/RED (18G-8")
- C: JAUNE-BLANC (18G-114")
YELLOW-WHITE

- 1: ROUGE/RED (12G-122")
- 2: NOIR/BLACK (12G-122")

CAPTEUR TEMPÉRATURE HUILE
OIL TEMPERATURE SENSOR

CAPTEUR NIVEAU HUILE
OIL LEVEL SENSOR

REFROIDISSEUR HUILE
OIL CHILLER

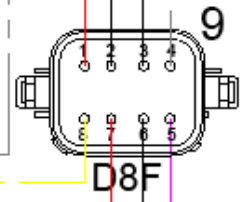

- 1: ROUGE/RED (12G-218")
- 2: NOIR/BLACK (12G-218")
- 3: NOIR-BLANC (18G-114")
BLACK-WHITE
- 4: GRIS-BLANC (18G-114")
GREY-WHITE
- 5: ROSE/PINK (18G-148")
- 6: NOIR / BLACK (12G-122")
- 7: ROUGE / RED (12G-122")
- 8: JAUNE-WHITE (18G-114")
YELLOW-WHITE

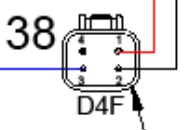

- 1: ROUGE/RED (18G-8")
- 2: NOIR/BLACK (18G-8")
- 3: BLEU/BLUE (18G-218")
- 4: BOUCHON/PLUG

BOUCHON
4 POLE MALE
G00032-1

SORTENT À 112°

GROUPE ANDERSON 5125, DE LA PLAISANCE CHESTERVILLE, QC, G0P 1J0 TÉL : (514) 382-2952	
No PIÈCE:	
DERNIER ENREGISTREMENT : 28-nov.-23	
FICHER : 28020.DWG	

315371

- | | |
|---------------------------|---------------------------|
| 1: NOIR/BLACK (18G-11") | 8: ROUGE-BLANC (18G-18") |
| 2: ROUGE/RED (18G-11") | 9: RED-WHITE |
| 3: JAUNE/YELLOW (18G-18") | 10: NOIR-BLANC (18G-18") |
| 4: VERT/GREEN (18G-18") | 11: BLACK-WHITE |
| 5: BLEU-BLANC (18G-18") | 12: VERT-BLANC (18G-18") |
| 6: BLEU-WHITE | 13: GREEN-WHITE |
| 7: BLANC/WHITE (18G-18") | 14: ROSE/PINK (18G-18") |
| 8: GRIS/GREY (18G-18") | 15: JAUNE-BLANC (18G-18") |
| | 16: YELLOW-WHITE |

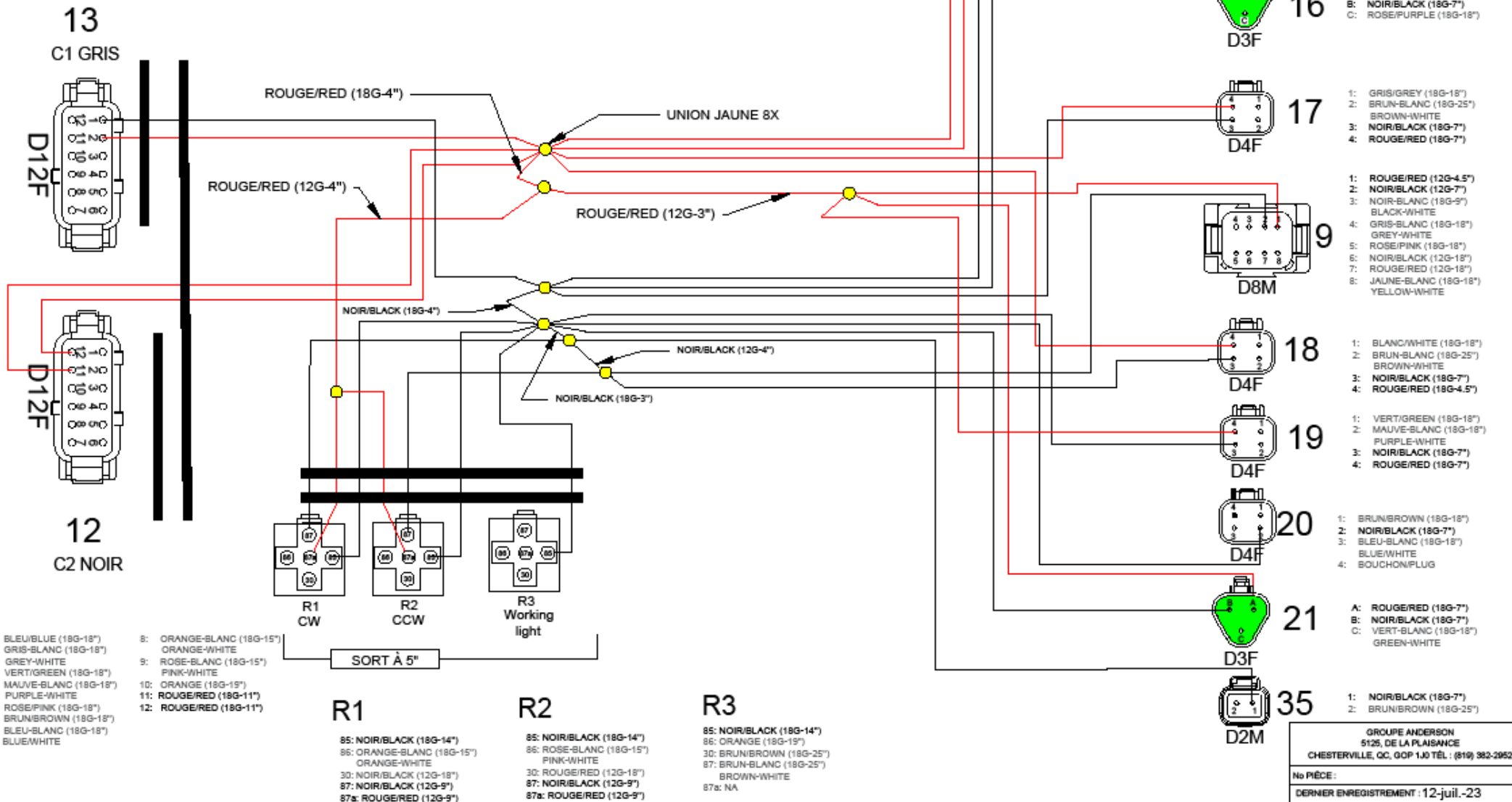

- | | |
|--------------------------|---------------------------|
| 1: BLEU/BLEU (18G-18") | 8: ORANGE-BLANC (18G-15") |
| 2: GRIS-BLANC (18G-18") | 9: ORANGE-WHITE |
| 3: GREY-WHITE | 10: ROSE-BLANC (18G-15") |
| 4: VERT/GREEN (18G-18") | 11: PINK-WHITE |
| 5: MAUVE-BLANC (18G-18") | 12: ORANGE (18G-15") |
| 6: PURPLE-WHITE | 13: ROUGE/RED (18G-11") |
| 7: ROSE/PINK (18G-18") | 14: ROUGE/RED (18G-11") |
| 8: BRUN/BROWN (18G-18") | |
| 9: BLEU-BLANC (18G-18") | |
| 10: BLUE-WHITE | |

- R1**
- 85: NOIR/BLACK (18G-14")
86: ORANGE-BLANC (18G-15")
ORANGE-WHITE
30: NOIR/BLACK (12G-18")
87: NOIR/BLACK (12G-9")
87a: ROUGE/RED (12G-9")
- R2**
- 85: NOIR/BLACK (18G-14")
86: ROSE-BLANC (18G-15")
PINK-WHITE
30: ROUGE/RED (12G-18")
87: NOIR/BLACK (12G-9")
87a: ROUGE/RED (12G-9")

- R3**
- 85: NOIR/BLACK (18G-14")
86: ORANGE (18G-15")
30: BRUN/BROWN (18G-25")
87: BRUN-BLANC (18G-25")
BROWN-WHITE
87a: NA

GRUPE ANDERSON
5125, DE LA PLAISANCE
CHESTERTVILLE, QC, G0P 1J0 TEL : (819) 382-2952

No PIÈCE:

DERNIER ENREGISTREMENT : 12-juil.-23

FICHER : 2023_P1.DWG

315371



- 1: NOIR/BLACK (18G-11")
- 2: ROUGE/RED (18G-11")
- 3: JAUNE/YELLOW (18G-18")
- 4: VERT/GREEN (18G-18")
- 5: BLEU-BLANC (18G-18")
BLUE-WHITE
- 6: BLANC/WHITE (18G-18")
- 7: GRIS/GREY (18G-18")
- 8: ROUGE-BLANC (18G-18")
RED-WHITE
- 9: NOIR-BLANC (18G-18")
BLACK-WHITE
- 10: VERT-BLANC (18G-18")
GREEN-WHITE
- 11: ROSE/PINK (18G-18")
- 12: JAUNE-BLANC (18G-18")
YELLOW-WHITE

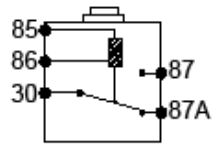
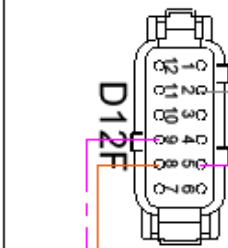
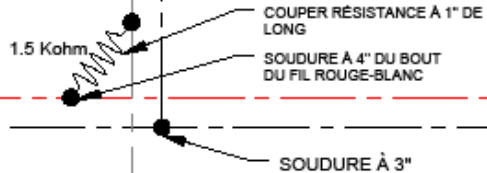
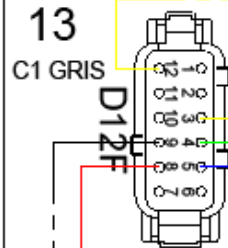

12
C2 NOIR

- 1: BLEU/BLUE (18G-18")
- 2: GRIS-BLANC (18G-18")
GREY-WHITE
- 3: VERT/GREEN (18G-18")
- 4: MAUVE-BLANC (18G-18")
PURPLE-WHITE
- 5: ROSE/PINK (18G-18")
- 6: BRUN/BROWN (18G-18")
- 7: BLEU-BLANC (18G-18")
BLUE-WHITE
- 8: ORANGE-BLANC (18G-15")
ORANGE-WHITE
- 9: ROSE-BLANC (18G-15")
PINK-WHITE
- 10: ORANGE (18G-19")
- 11: ROUGE/RED (18G-11")
- 12: ROUGE/RED (18G-11")

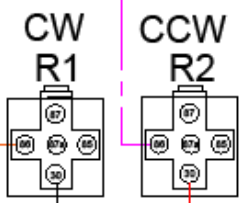

- R1
- 85: NOIR/BLACK (18G-14")
 - 86: ORANGE-BLANC (18G-15")
ORANGE-WHITE
 - 30: NOIR/BLACK (12G-18")
 - 87: NOIR/BLACK (12G-9")
 - 87a: ROUGE/RED (12G-9")

- R2
- 85: NOIR/BLACK (18G-14")
 - 86: ROSE-BLANC (18G-15")
PINK-WHITE
 - 30: ROUGE/RED (12G-18")
 - 87: NOIR/BLACK (12G-9")
 - 87a: ROUGE/RED (12G-9")

SORT À 5"

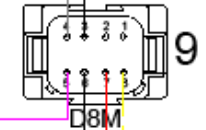

- 1: ROUGE/RED (12G-4.5")
- 2: NOIR/BLACK (12G-7")
- 3: NOIR-BLANC (18G-9")
BLACK-WHITE
- 4: GRIS-BLANC (18G-18")
GREY-WHITE
- 5: ROSE/PINK (18G-18")
- 6: NOIR/BLACK (12G-18")
- 7: ROUGE/RED (12G-18")
- 8: JAUNE-BLANC (18G-18")
YELLOW-WHITE

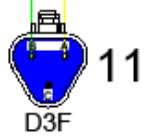

- A: JAUNE/YELLOW (18G-18")
- B: VERT/GREEN (18G-18")
- C: BOUCHON/PLUG

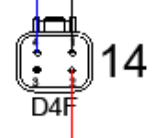

- 1: NOIR-BLANC (18G-18")
BLACK-WHITE
- 2: ROUGE-BLANC (18G-18")
RED-WHITE
- 3: BOUCHON/PLUG
- 4: BLEU-BLANC (18G-18")
BLUE-WHITE

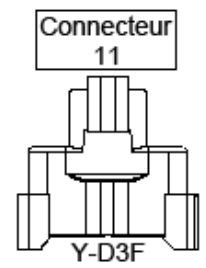

RÉSIST.

GROUPE ANDERSON 5125, DE LA PLAISANCE CHESTERTVILLE, QC, G0P 1J0 TEL : (819) 382-2952	
No PIÈCE :	
DERNIER ENREGISTREMENT : 12-juil.-23	
FICHER : 2007_P2008	

315371



- 1: NOIR/BLACK (18G-11")
- 2: ROUGE/RED (18G-11")
- 3: JAUNE/YELLOW (18G-18")
- 4: VERT/GREEN (18G-18")
- 5: BLEU-BLANC (18G-18")
BLUE-WHITE
- 6: BLANC/WHITE (18G-18")
- 7: GRIS/GREY (18G-18")
- 8: ROUGE-BLANC (18G-18")
RED-WHITE
- 9: NOIR-BLANC (18G-18")
BLACK-WHITE
- 10: VERT-BLANC (18G-18")
GREEN-WHITE
- 11: ROSE/PINK (18G-18")
- 12: JAUNE-BLANC (18G-18")
YELLOW-WHITE

13

C1 GRIS

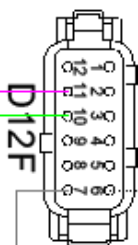

12

C2 NOIR

- 1: BLEU/BLUE (18G-18")
- 2: GRIS-BLANC (18G-18")
GREY-WHITE
- 3: VERT/GREEN (18G-18")
- 4: MAUVE-BLANC (18G-18")
PURPLE-WHITE
- 5: ROSE/PINK (18G-18")
- 6: BRUN/BROWN (18G-18")
- 7: BLEU-BLANC (18G-18")
BLUE-WHITE
- 8: ORANGE-BLANC (18G-15")
ORANGE-WHITE
- 9: ROSE-BLANC (18G-15")
PINK-WHITE
- 10: ORANGE (18G-15")
- 11: ROUGE/RED (18G-11")
- 12: ROUGE/RED (18G-11")

R3

- 85: NOIR/BLACK (18G-14")
 - 86: ORANGE (18G-15")
 - 30: BRUN/BROWN (18G-17")
 - 87: BRUN-BLANC (18G-18")
BROWN-WHITE
- 87 s: NA

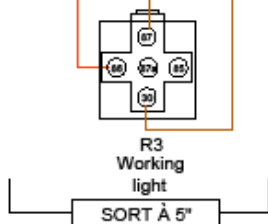

SOUDURE À 7"

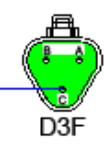

15

- A: ROUGE/RED (18G-7")
- B: NOIR/BLACK (18G-7")
- C: BLEU/BLUE (18G-18")

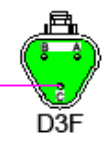

16

- A: ROUGE/RED (18G-7")
- B: NOIR/BLACK (18G-7")
- C: ROSE/PURPLE (18G-18")



17

- 1: GRIS/GREY (18G-18")
- 2: BRUN-BLANC (18G-25")
BROWN-WHITE
- 3: NOIR/BLACK (18G-7")
- 4: ROUGE/RED (18G-7")



18

- 1: BLANC/WHITE (18G-18")
- 2: BRUN-BLANC (18G-25")
BROWN-WHITE
- 3: NOIR/BLACK (18G-7")
- 4: ROUGE/RED (18G-4.5")

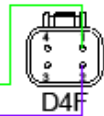

19

- 1: VERT/GREEN (18G-18")
- 2: MAUVE-BLANC (18G-18")
PURPLE-WHITE
- 3: NOIR/BLACK (18G-7")
- 4: ROUGE/RED (18G-7")

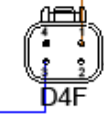

20

- 1: BRUN/BROWN (18G-18")
- 2: NOIR/BLACK (18G-7")
- 3: BLEU-BLANC (18G-18")
BLUE-WHITE
- 4: BOUCHON/PLUG

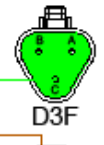

21

- A: ROUGE/RED (18G-7")
- B: NOIR/BLACK (18G-7")
- C: VERT-BLANC (18G-18")
GREEN-WHITE



35

- 1: NOIR/BLACK (18G-7")
- 2: BRUN/BROWN (18G-18")

GRUPE ANDERSON
5125, DE LA PLAISANCE
CHESTERVILLE, QC, G0P 1J0 TÉL : (819) 382-2952

No PIÈCE :
DERNIER ENREGISTREMENT : 12-juil.-23
FICHER : 2023_P1234

315372

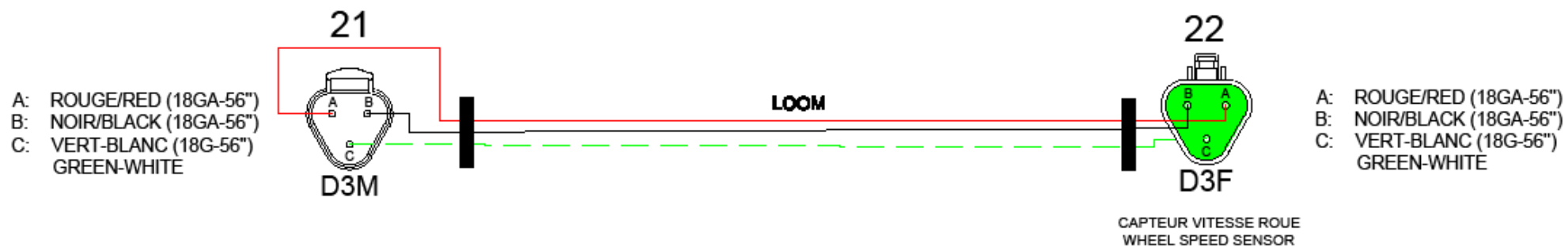

GRUPE ANDERSON 5125, DE LA PLAISANCE CHESTERVILLE, QC, G0P 1J0 TEL : (514) 382-2952
No PIÈCE :
DERNIER ENREGISTREMENT : 9-janv.-23
FICHER : 2002.0908

315373

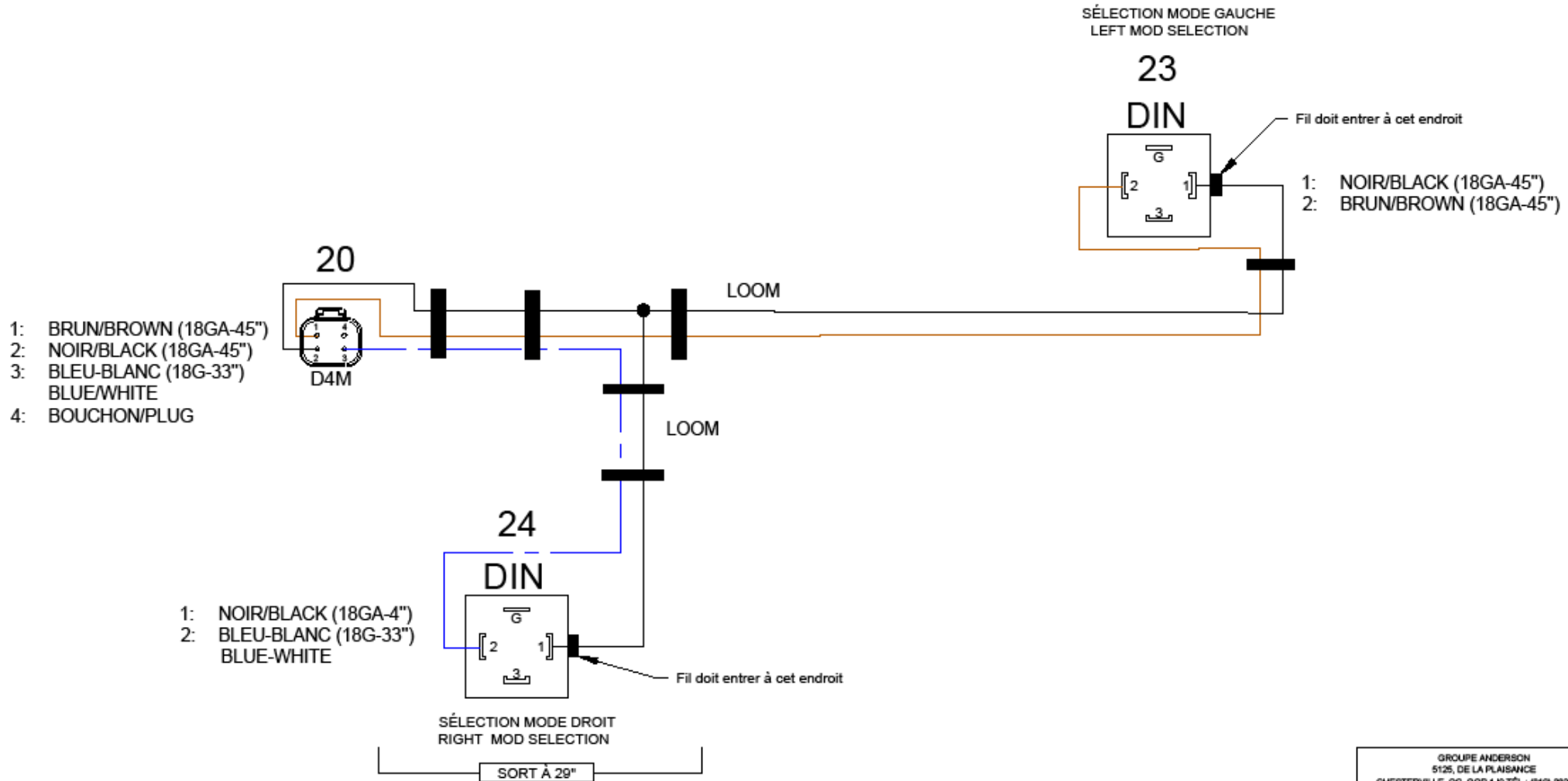

GRUPE ANDERSON 5125, DE LA PLAISANCE CHESTERVILLE, QC, G0P 1J0 TÉL : (819) 382-2952
No PIÈCE :
DERNIER ENREGISTREMENT : 9-mai-23
FICHER : 315373

315374

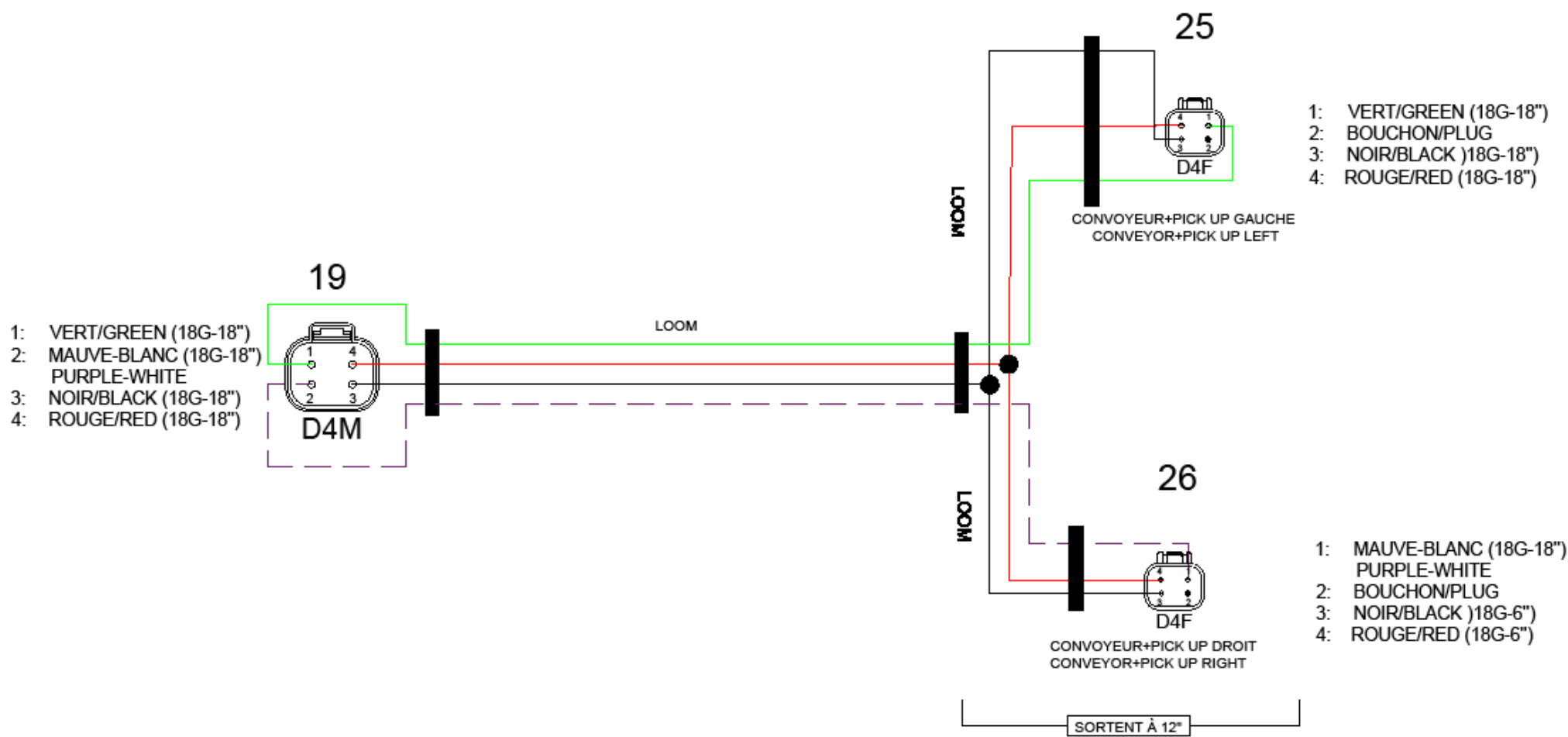

GRUPE ANDERSON 5125, DE LA PLAISANCE CHESTERVILLE, QC, G0P 1J0 TÉL : (514) 382-2952
No PIÈCE :
DERNIER ENREGISTREMENT : 27-nov.-23
FICHER : 20024.DWG

315375

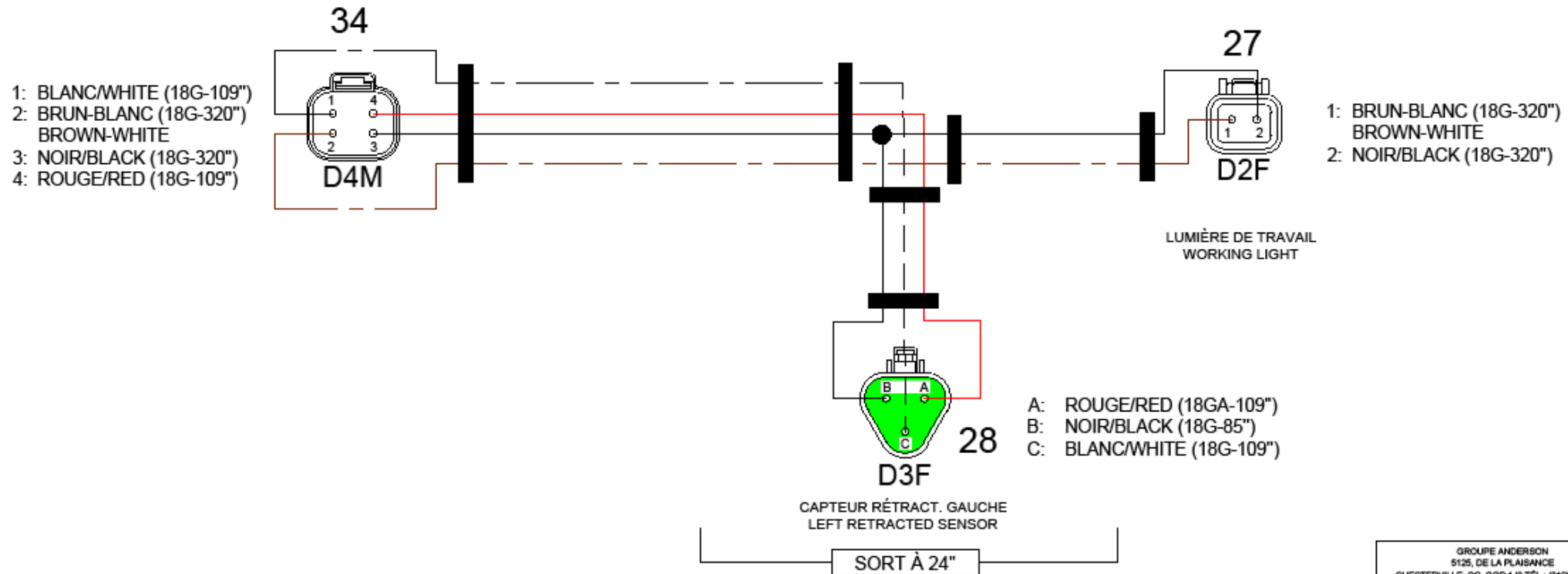

GRUPE ANDERSON 5125, DE LA PLAISANCE CHESTERVILLE, QC, G0P 1J0 TÉL : (514) 382-2952
No PIÈCE :
DERNIER ENREGISTREMENT : 17-avr.-23
FICHER : 315375

315376

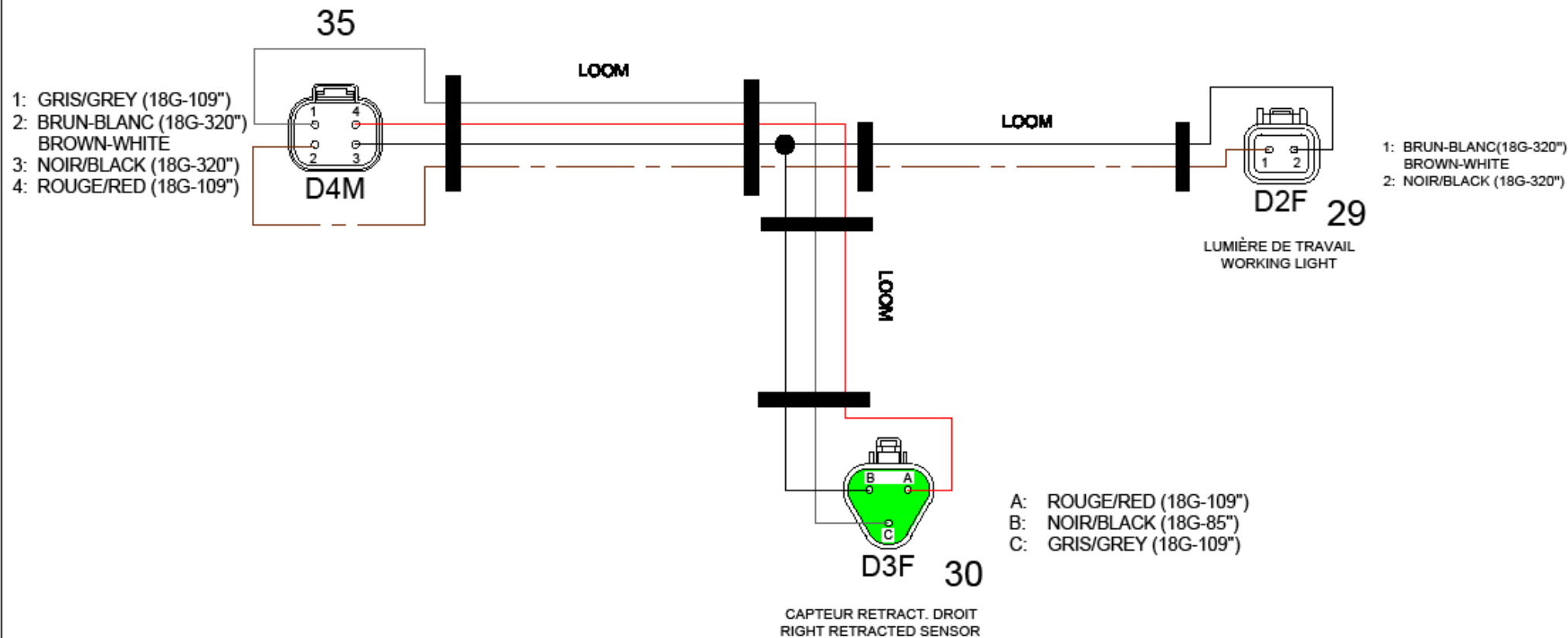

SORT À 24"

GROUPE ANDERSON 5125, DE LA PLAISANCE CHESTERVILLE, QC, G0P 1J0 TÉL : (514) 382-2952
No PIÈCE :
DERNIER ENREGISTREMENT : 17-avr.-23
FICHER : 315376.DWG

315377

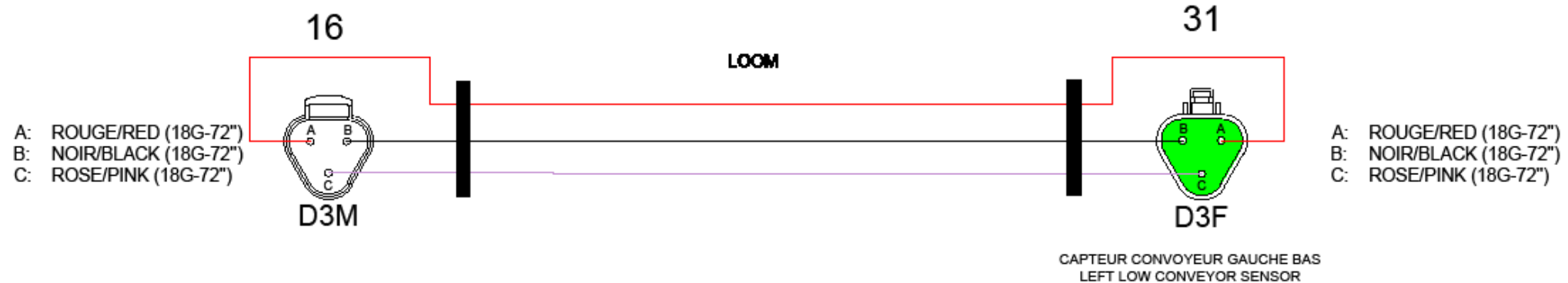

GRUPE ANDERSON 5125, DE LA PLAISANCE CHESTERVILLE, QC, G0P 1J0 TEL : (514) 382-2952
No PIÈCE :
DERNIER ENREGISTREMENT : 9-janv.-23
FICHER : 2007.DRM

315378

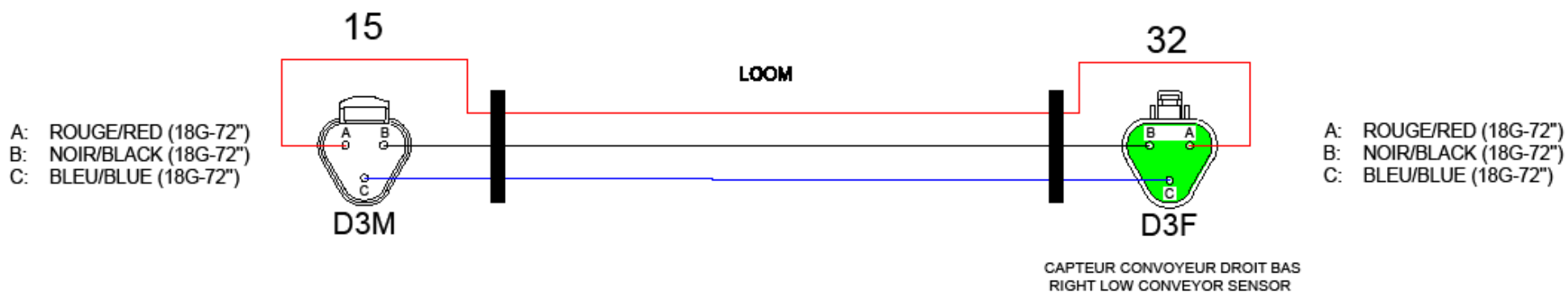

GRUPE ANDERSON 5125, DE LA PLAISANCE CHESTERVILLE, QC, G0P 1J0 TEL : (514) 382-2952
No PIÈCE :
DERNIER ENREGISTREMENT : 9-janv.-23
FICHER : 315378.DWG

315379

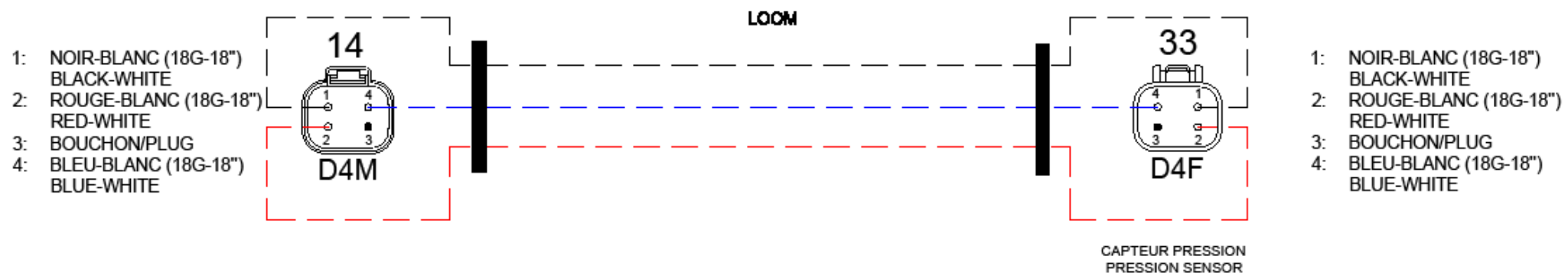

GRUPE ANDERSON 5125, DE LA PLAISANCE CHESTERVILLE, QC, G0P 1J0 TEL : (514) 382-2952
No PIÈCE :
DERNIER ENREGISTREMENT : 9-janv.-23
FICHER : 315379

315380



- 1: GRIS/GREY (18G-86")
- 2: BRUN-BLANC (18G-86")
BROWN-WHITE
- 3: NOIR/BLACK (18G-86")
- 4: ROUGE/RED (18G-86")

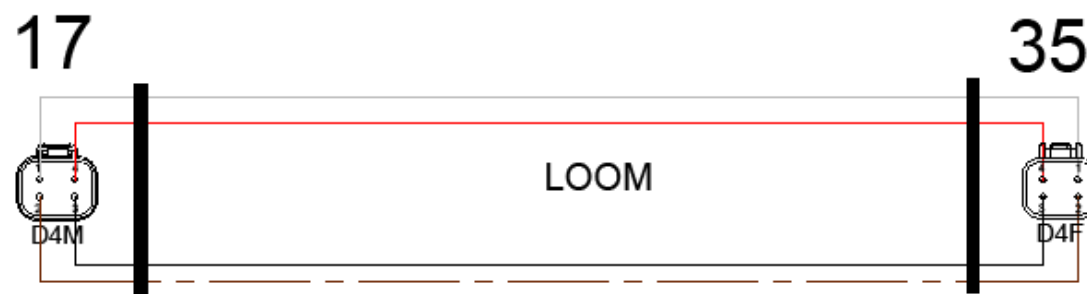

- 1: GRIS/GREY (18G-86")
- 2: BRUN-BLANC (18G-86")
BROWN-WHITE
- 3: NOIR/BLACK (18G-86")
- 4: ROUGE/RED (18G-86")

GRUPE ANDERSON 5125, DE LA PLAISANCE CHESTERVILLE, QC, G0P 1J0 TÈL : (514) 382-2952
No PIÈCE :
DERNIER ENREGISTREMENT : 24-janv.-23
FICHER : 315380

315381



- 1: BLANC/WHITE (18G-88")
- 2: BRUN-BLANC (18G-88")
BROWN-WHITE
- 3: NOIR/BLACK (18G-88")
- 4: ROUGE/RED (18G-88")

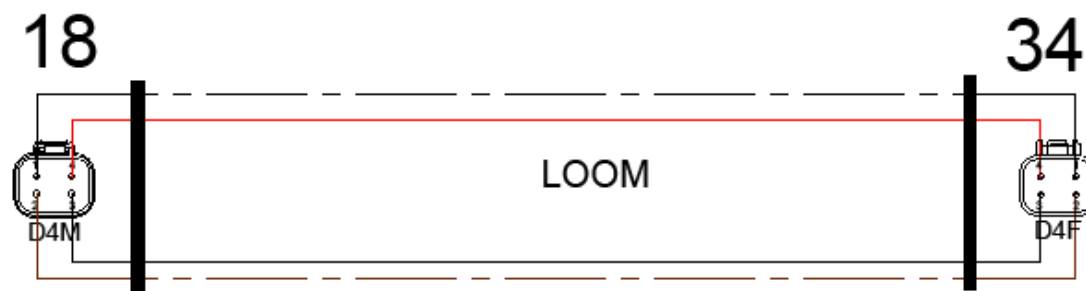

- 1: BLANC/WHITE (18G-88")
- 2: BRUN-BLANC (18G-88")
BROWN-WHITE
- 3: NOIR/BLACK (18G-88")
- 4: ROUGE/RED (18G-88")

GRUPE ANDERSON 5125, DE LA PLAISANCE CHESTERVILLE, QC, G0P 1J0 TÉL : (514) 382-2952
No PIÈCE :
DERNIER ENREGISTREMENT : 24-janv.-23
FICHER : 20001.DWG

315405

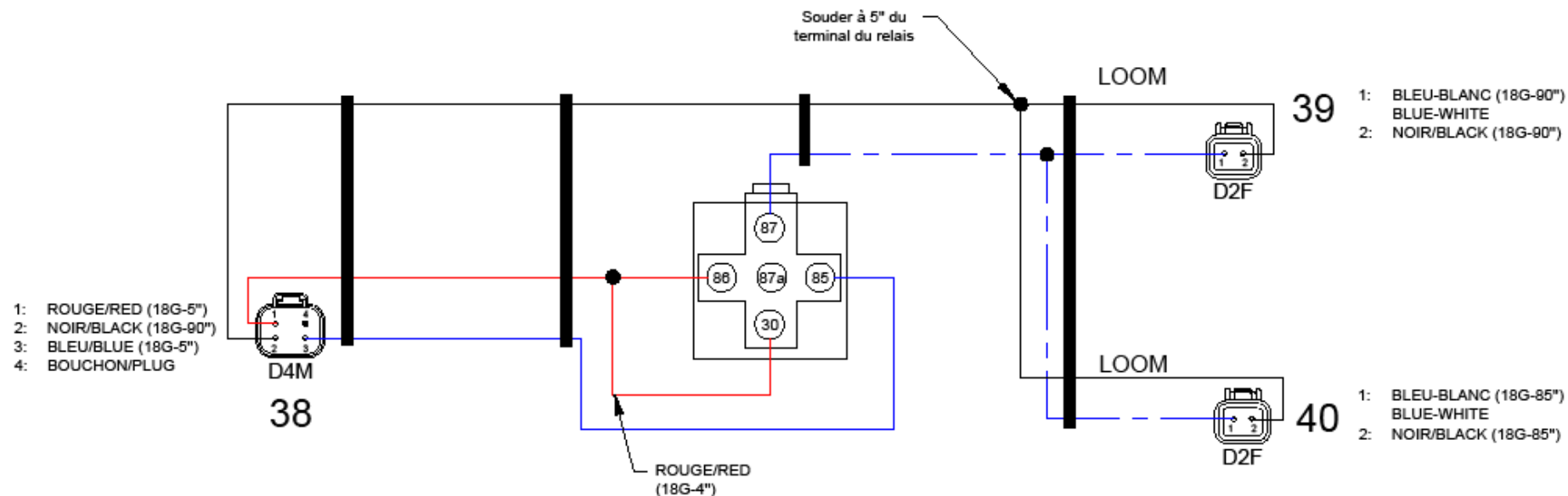

- 85: BLEU/BLUE (18G-5")
- 86: ROUGE/RED (18G-5")
- 87: BLEU-BLANC (18G-90")
BLUE-WHITE
- 87A: BOUCHON
- 30: ROUGE/RED (18G-4")

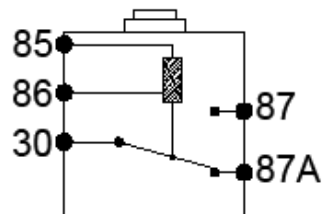

GRUPE ANDERSON 5125, DE LA PLAISANCE CHESTERVILLE, QC, G0P 1J0 TEL : (514) 382-2952
No PIÈCE :
DERNIER ENREGISTREMENT : 21-nov.-23
FICHER : 20040000

315406



GRUPE ANDERSON 5125, DE LA PLAISANCE CHESTERVILLE, QC, G0P 1J0 TÉL : (514) 382-2952
No PIÈCE :
DERNIER ENREGISTREMENT : 29-nov.-23
FICHER : 20240106

315407

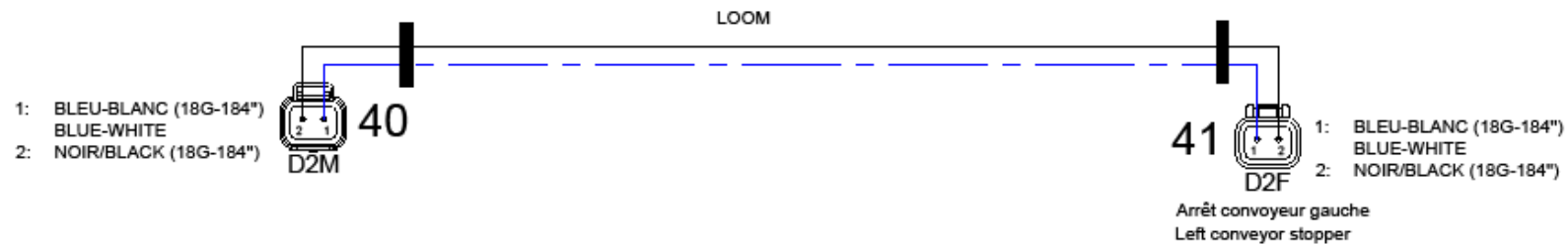

GRUPE ANDERSON 5125, DE LA PLAISANCE CHESTERVILLE, QC, G0P 1J0 TEL : (514) 382-2952
No PIÈCE :
DERNIER ENREGISTREMENT : 29-nov.-23
FICHIER : 315407.DWG

315410

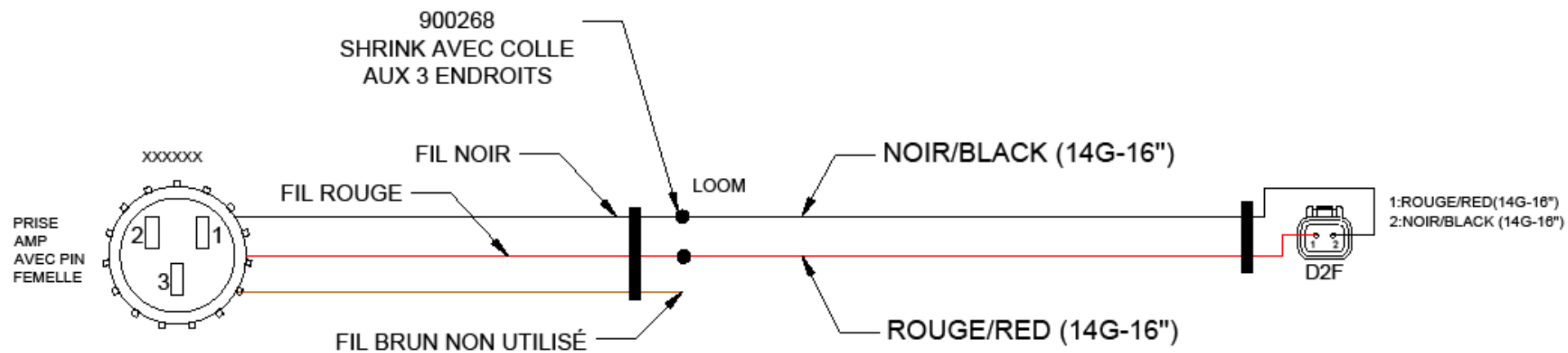

LONGUEUR TOTALE = 48"

GRUPE ANDERSON 5125, DE LA PLAISANCE CHESTERVILLE, QC, G0P 1J0 TEL : (514) 382-2952
No PIÈCE :
DERNIER ENREGISTREMENT : 20-nov.-23
FICHER : 315410