



STACKPRO 5400

Electric Diagram / Diagramme Électrique

To navigate the electric diagram, you can click on the **red rectangle** that identify the wiring section you want to look up, click on the

Back

button to go back to the main section.

Pour naviguer dans le schéma électrique, vous pouvez cliquer sur les **rectangles rouges** qui identifie la section du câblage que vous souhaitez regarder, cliquez sur le bouton

Back

pour revenir à la section principale.

DIAGRAMME ÉLECTRIQUE/ELECTRIC DIAGRAM – STACKPRO 5400

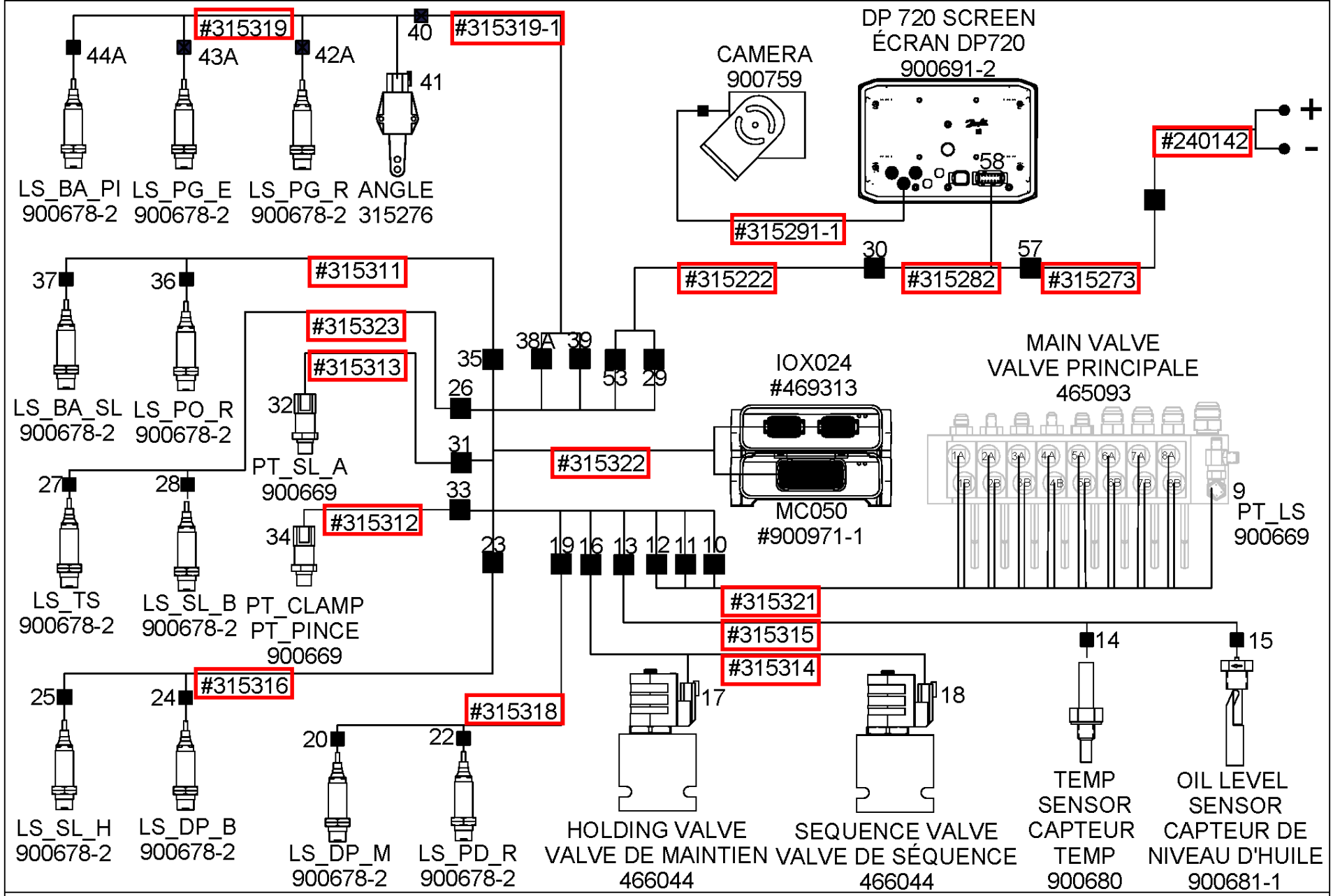

240142

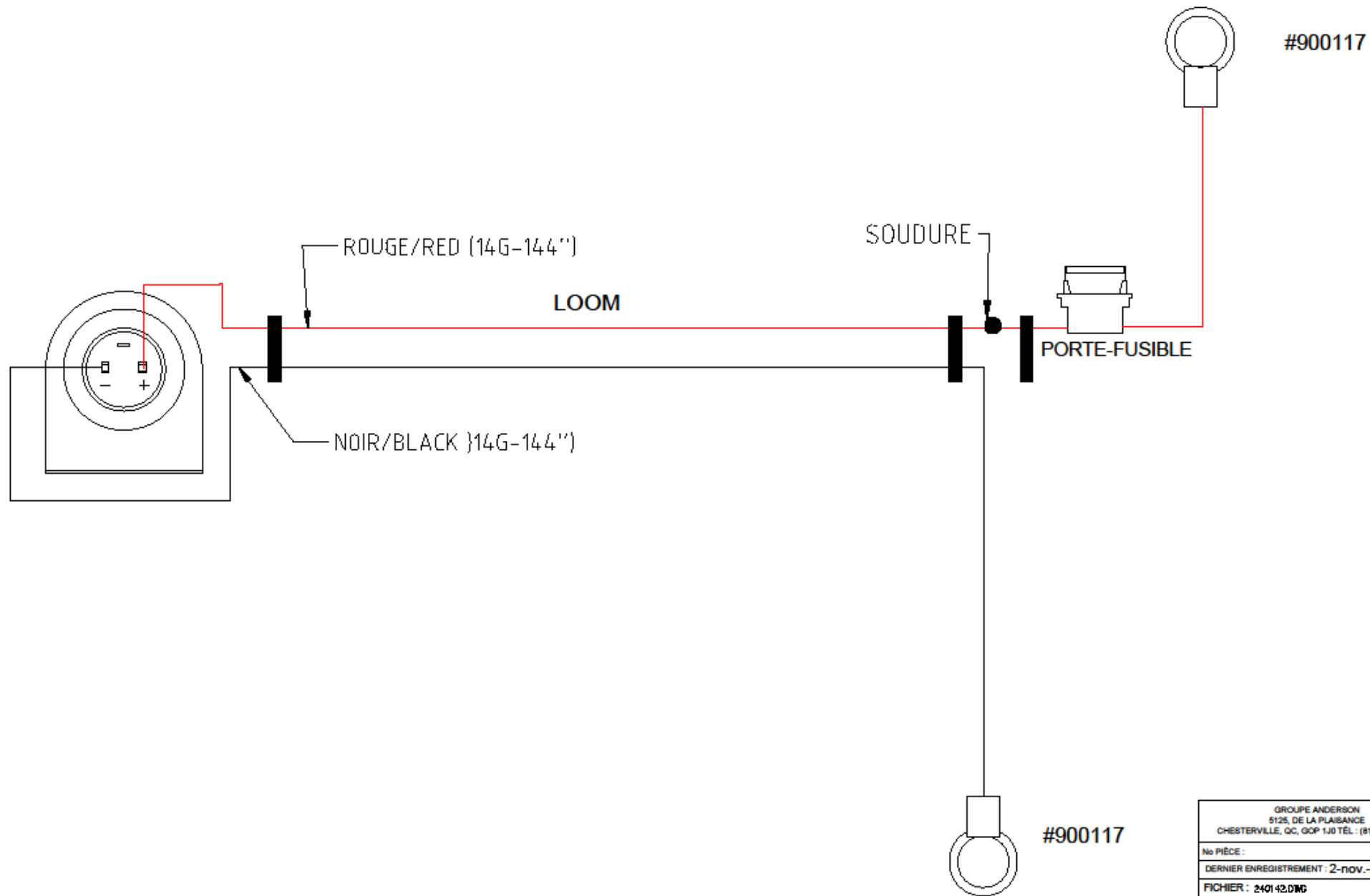

GRUPE ANDERSON 5125, DE LA PLAISANCE CHESTERVILLE, QC, G0P 1J0 TEL : (819) 382-2952
No PIÈCE :
DERNIER ENREGISTREMENT : 2-nov.-20
FICHER : 240142.DWG

315222

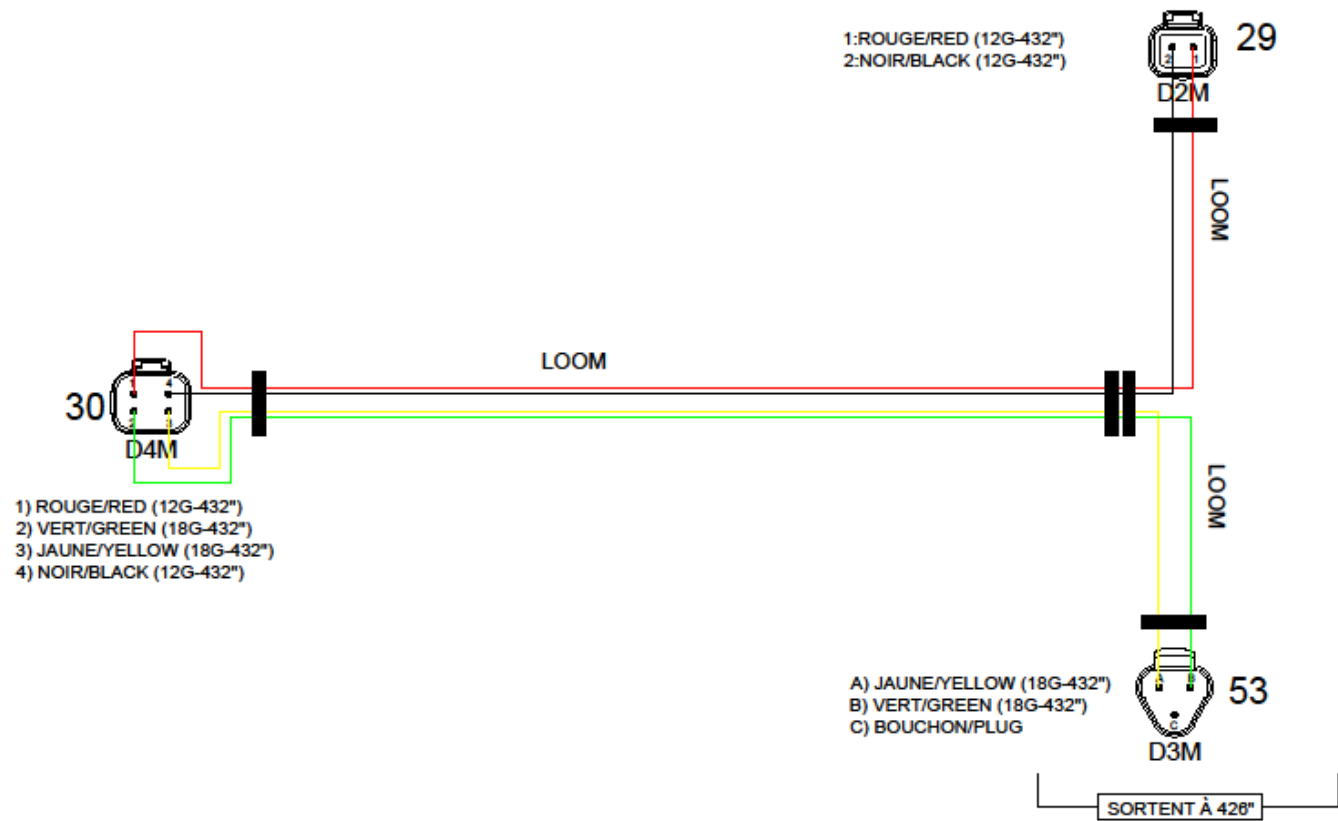

- 1) ROUGE/RED (12G-432")
- 2) VERT/GREEN (18G-432")
- 3) JAUNE/YELLOW (18G-432")
- 4) NOIR/BLACK (12G-432")

GRUPE ANDERSON 5125, DE LA PLAISANCE CHESTERVILLE, QC, G0P 1J0 TÉL : (514) 382-2952
No PIÈCE :
DERNIER ENREGISTREMENT : 1-déc.-20
FICHER : 315222.LWM

315273

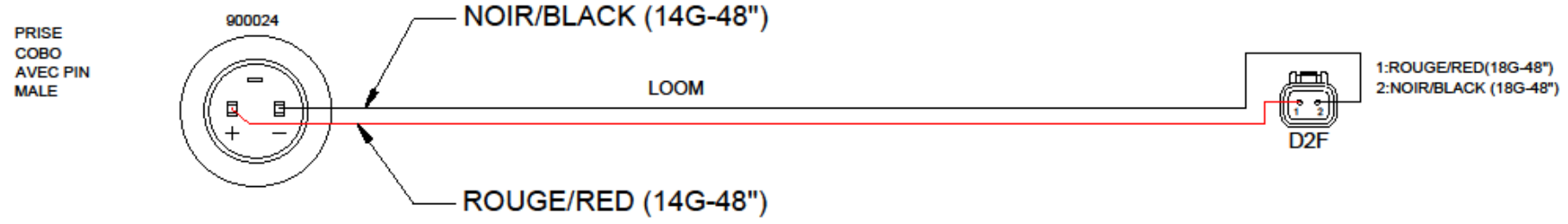

GRUPE ANDERSON 5125, DE LA PLAISANCE CHESTERVILLE, QC, G0P 1J0 TÉL. : (514) 382-2952
No PIÈCE :
DERNIER ENREGISTREMENT : 31-mars-21
FICHER : 31 0273.01WC

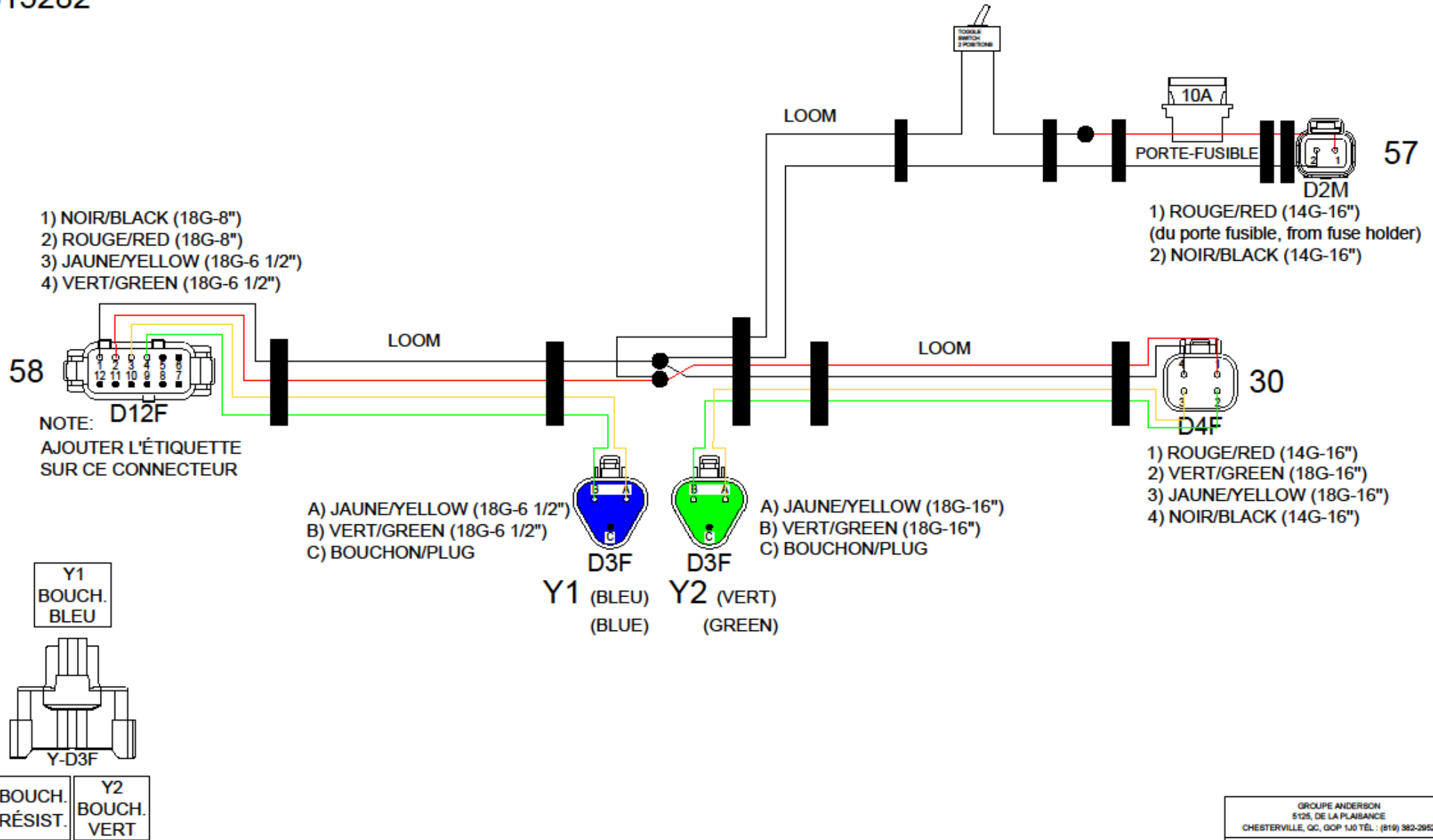

315291-1

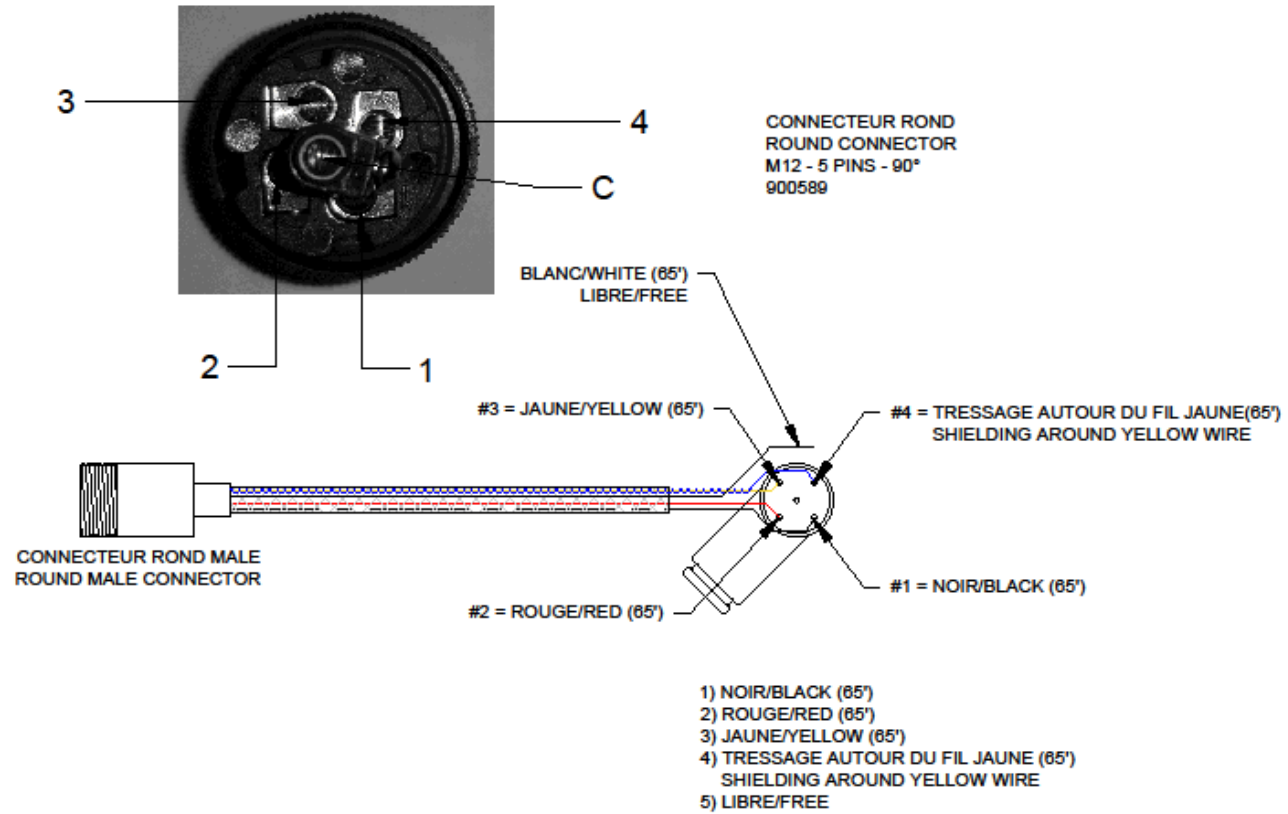

GRUPE ANDERSON 5125, DE LA PLAISANCE CHESTERVILLE, QC, G0P 1J0 TÉL. : (819) 382-2952
No PIÈCE :
DERNIER ENREGISTREMENT : 8-mai-20
FICHER : 074-FIL 315291-1.DWG

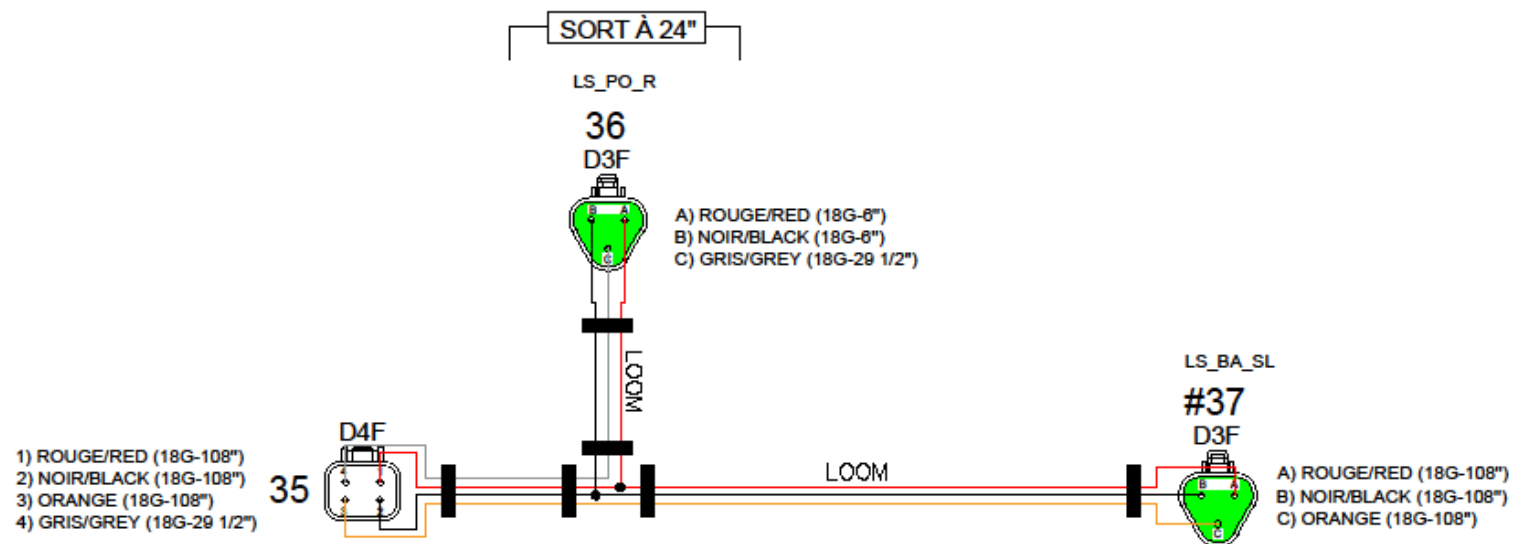

315312



- 1) NOIR-BLANC (18G-30")
BLACK-WHITE
- 2) ROUGE-BLANC (18G-30")
RED-WHITE
- 3) BOUCHON/PLUG
- 4) BRUN/BROWN (18G-30")

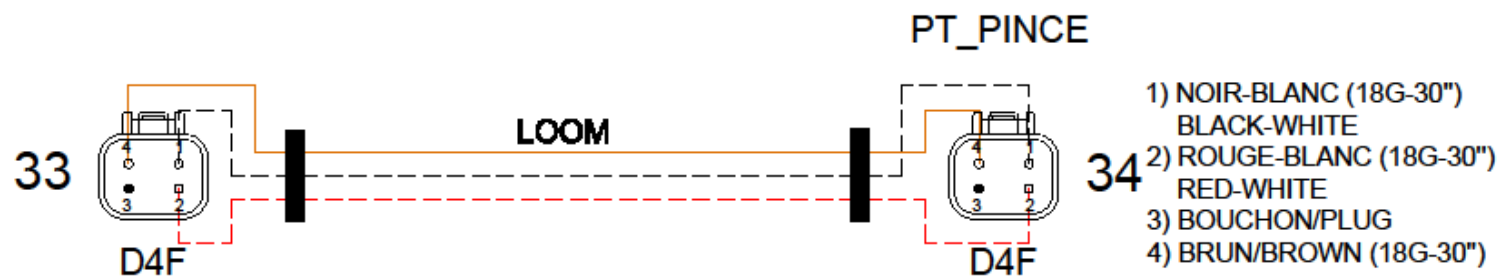

- 1) NOIR-BLANC (18G-30")
BLACK-WHITE
- 2) ROUGE-BLANC (18G-30")
RED-WHITE
- 3) BOUCHON/PLUG
- 4) BRUN/BROWN (18G-30")

315313



- 1) NOIR-BLANC (18G-46")
BLACK-WHITE
- 2) ROUGE-BLANC (18G-46")
RED-WHITE
- 3) BOUCHON/PLUG
- 4) ORANGE (18G-46")

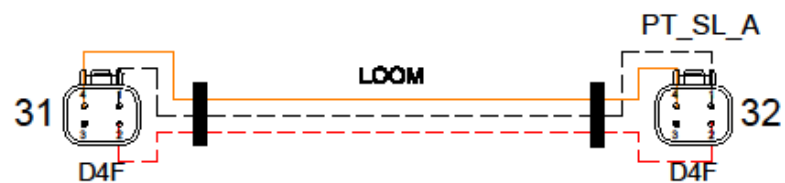

- 1) NOIR-BLANC (18G-46")
BLACK-WHITE
- 2) ROUGE-BLANC (18G-46")
RED-WHITE
- 3) BOUCHON/PLUG
- 4) ORANGE (18G-46")

GRUPE ANDERSON 5125, DE LA PLAISANCE CHESTERVILLE, QC, GOP 1J0 T�L : (819) 382-2952
No PI�CE :
DERNIER ENREGISTREMENT : 11-mai-20
FICHER : 20000.DWG

315314

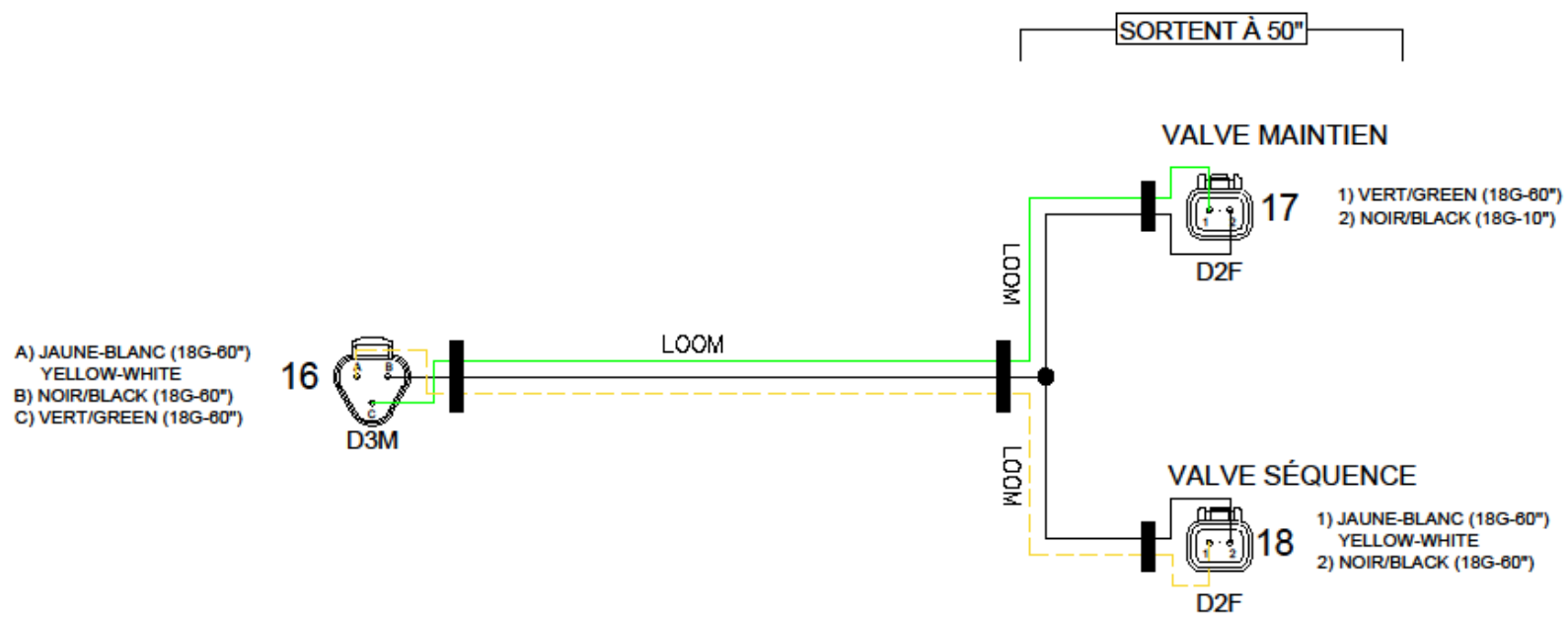

GRUPE ANDERSON 5125, DE LA PLAISANCE CHESTERVILLE, QC, G0P 1J0 TEL : (819) 382-2052
No PIÈCE :
DERNIER ENREGISTREMENT : 31-mars-21
FICHER : 310314.DWG

315315

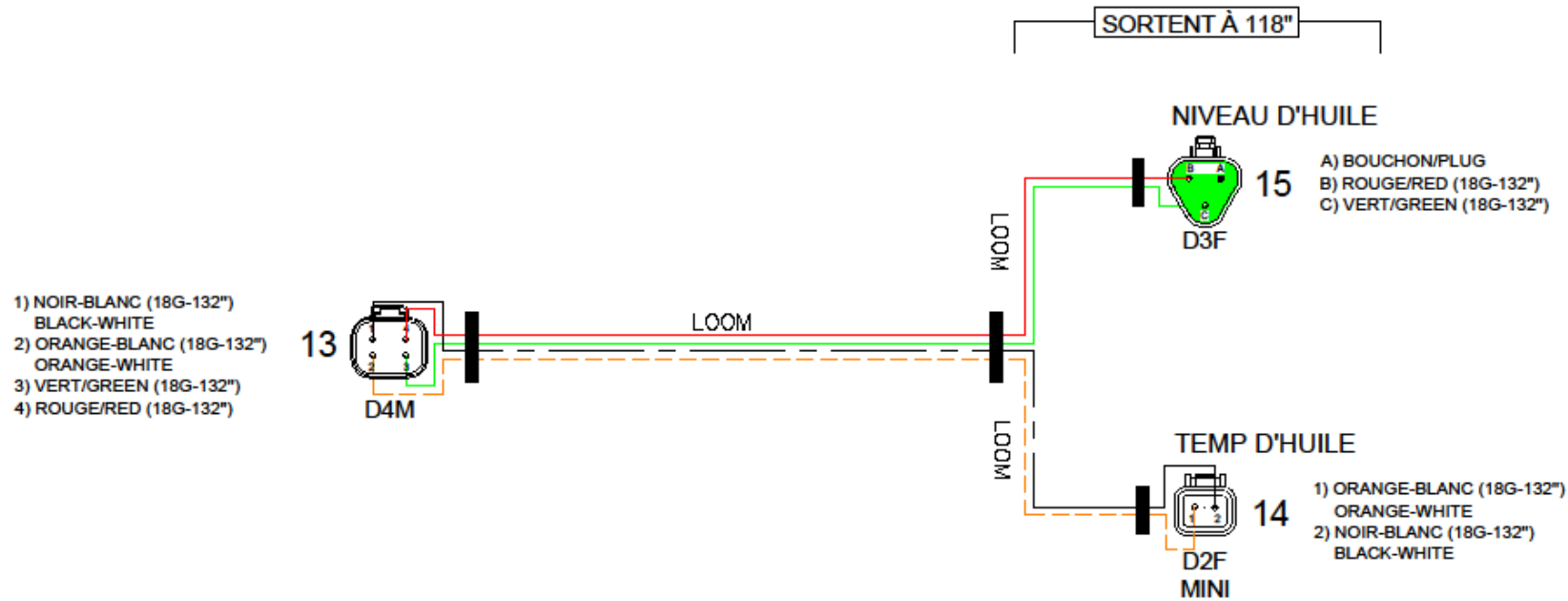

GRUPE ANDERSON 5125, DE LA PLAISANCE CHESTERVILLE, QC, G0P 1J0 TÉL. : (819) 382-2952
No PIÈCE :
DERNIER ENREGISTREMENT : 29-oct.-20
FICHER : 310315.DWG

315316

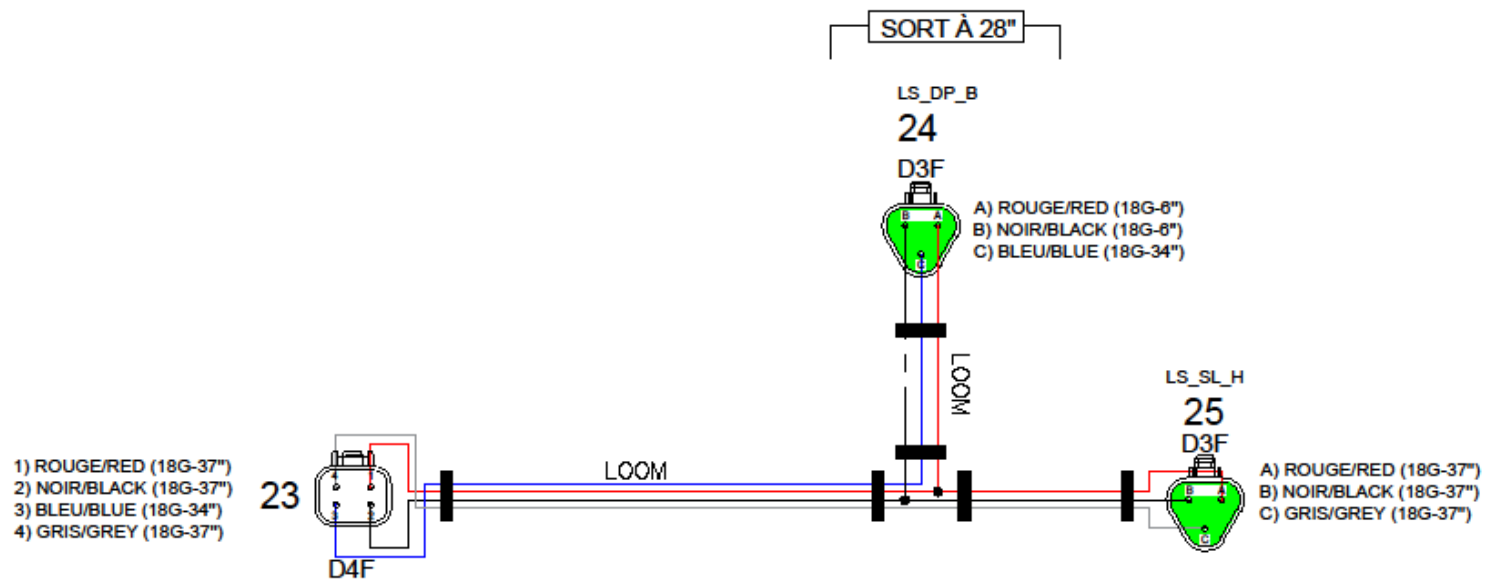

GRUPE ANDERSON 5125, DE LA PLAISANCE CHESTERVILLE, QC, G0P 1J0 TÈL. : (514) 382-2952
No PIÈCE :
DERNIER ENREGISTREMENT : 31-mars-21
FICHER : 31 0318LDWC

315318

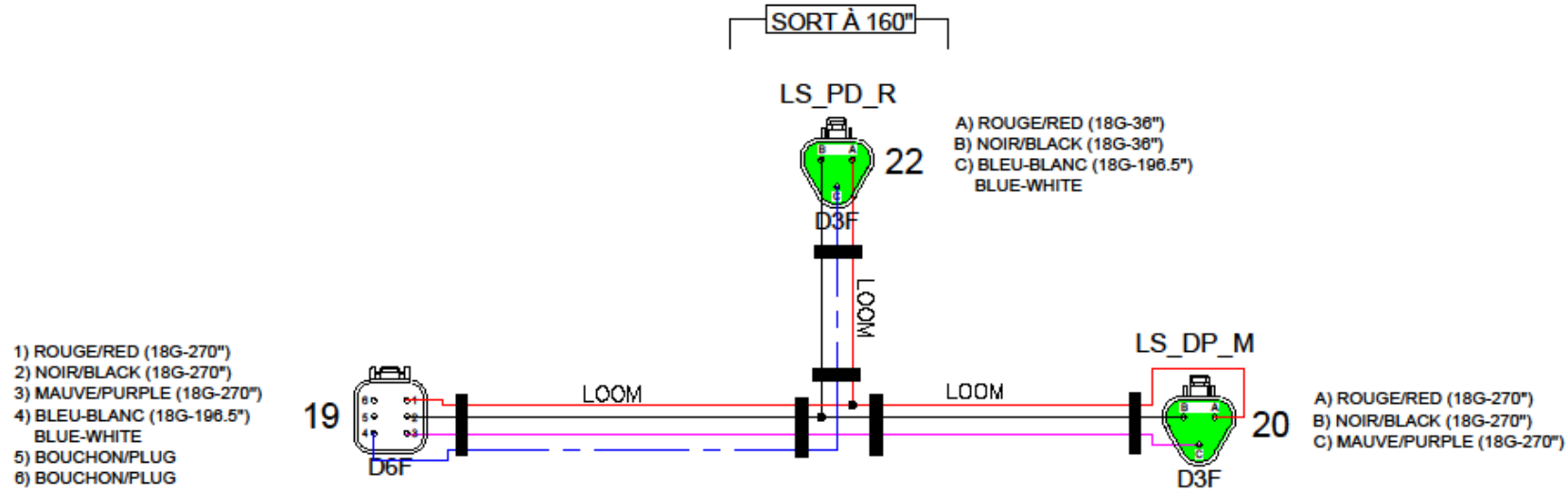

GRUPE ANDERSON 5125, DE LA PLAISANCE CHESTERVILLE, QC, QOP 1J0 TÉL : (514) 382-2952
No PIÈCE :
DERNIER ENREGISTREMENT : 21-sept-22
FICHIER : 315318.DWG

315319-1



- 1) BOUCHON/PLUG
- 2) ROUGE/RED (18G-110")
- 3) NOIR/BLACK (18G-110")
- 4) JAUNE/YELLOW (18G-110")
- 5) ROSE/PINK (18G-110")
- 6) MAUVE/PURPLE (18G-110")
- 7) VERT/GREEN (18G-110")
- 8) JAUNE-NOIR (18G-110")
YELLOW-BLACK

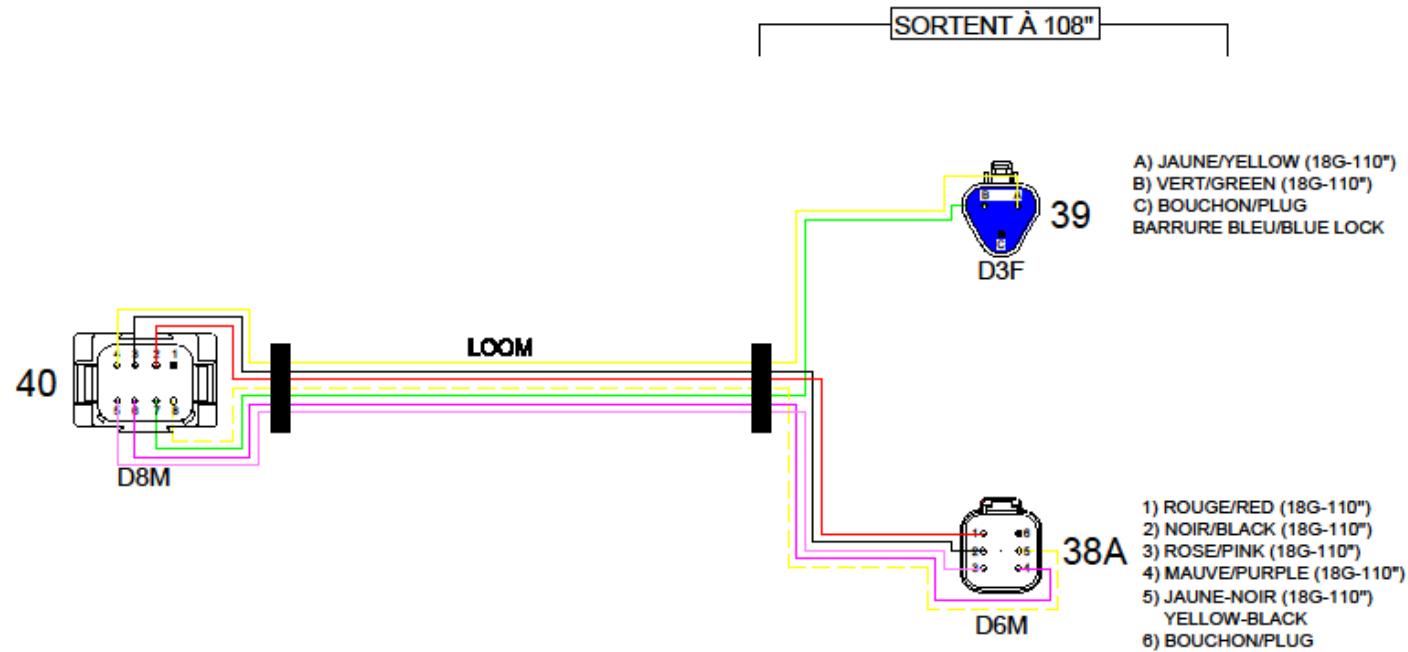

GRUPE ANDERSON 5125, DE LA PLAISANCE CHESTERVILLE, QC, G0P 1J0 TEL : (514) 382-2952
No PIÈCE :
DERNIER ENREGISTREMENT : 10-juin-20
FICHER : 315319-1.DWG

315321**1A** 1) ROUGE-BLANC (18G-26")
RED-WHITE
2) NOIR/BLACK (18G-6 ½")**1B** 1) NOIR-BLANC (18G-26")
BLACK-WHITE
2) NOIR/BLACK (18G-6 ½")

SORTENT À 20"

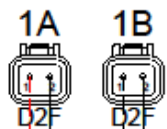
**3A** 1) JAUNE/YELLOW (18G-30")
2) NOIR/BLACK (18G-6 ½")**3B** 1) JAUNE-BLANC (18G-30")
YELLOW-WHITE
2) NOIR/BLACK (18G-6 ½")

SORTENT À 24"

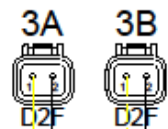
**5A** 1) BLEU/BLUE (18G-34")
2) NOIR/BLACK (18G-6 ½")**5B** 1) BLEU-BLANC (18G-34")
BLUE-WHITE
2) NOIR/BLACK (18G-6 ½")

SORTENT À 28"

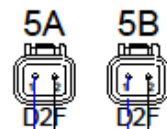
**7A** 1) GRIS/GREY (18G-38")
2) NOIR/BLACK (18G-6 ½")**7B** 1) GRIS-BLANC (18G-38")
GREY-WHITE
2) NOIR/BLACK (18G-6 ½")

SORTENT À 32"

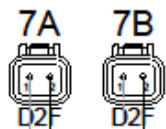
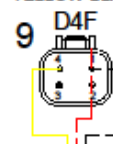
9 1) NOIR-BLANC (18G-44")
BLACK-WHITE
2) ROUGE-BLANC (18G-44")
RED-WHITE
3) BOUCHON/PLUG
4) JAUNE-NOIR (18G-44")
YELLOW-BLACK

LOOM (16 X)

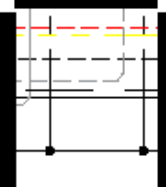
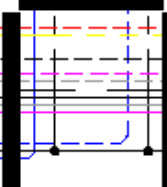
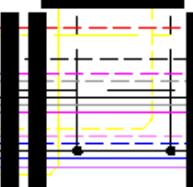
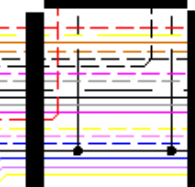
**2A** 1) BRUN/BROWN (18G-28")
2) NOIR/BLACK (18G-6 ½")**2B** 1) BRUN-BLANC (18G-28")
BROWN-WHITE
2) NOIR/BLACK (18G-6 ½")

SORTENT À 22"

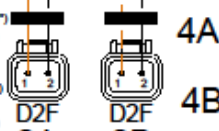
**4A** 1) ROSE/PINK (18G-32")
2) NOIR/BLACK (18G-6 ½")**4B** 1) ROSE-BLANC (18G-32")
PINK-WHITE
2) NOIR/BLACK (18G-6 ½")

SORTENT À 26"

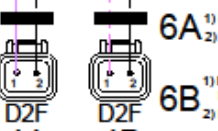
**6A** 1) MAUVE/PURPLE (18G-36")
2) NOIR/BLACK (18G-6 ½")**6B** 1) MAUVE-BLANC (18G-36")
PURPLE-WHITE
2) NOIR/BLACK (18G-6 ½")

SORTENT À 30"

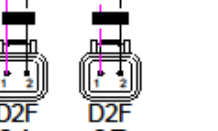
**8A** 1) BLANC/WHITE (18G-40")
2) NOIR/BLACK (18G-40")**8B** 1) BLANC-NOIR (18G-40")
WHITE-BLACK
2) NOIR/BLACK (18G-40")

SORTENT À 33 ½"

8A 1) BLANC/WHITE (18G-40")
2) NOIR/BLACK (18G-40")**8B** 1) BLANC-NOIR (18G-40")
WHITE-BLACK
2) NOIR/BLACK (18G-40")

LOOM

SORTENT À 22"

SORTENT À 26"

SORTENT À 30"

SORTENT À 33 ½"

10 1) JAUNE/YELLOW (18G-30")
2) ROSE/PINK (18G-32")
3) BLEU/BLUE (18G-34")
4) BOUCHON/PLUG
5) NOIR/BLACK (18G-40")
6) BLEU-BLANC/BLUE-WHITE (18G-34")
7) ROSE-BLANC/PINK-WHITE (18G-32")
8) JAUNE-BLANC/YELLOW-WHITE (18G-30")

11 1) ROUGE-BLANC/RED-WHITE (18G-26")
2) MAUVE/PURPLE (18G-36")
3) GRIS/GREY (18G-38")
4) BLANC/WHITE (18G-40")
5) BLANC-NOIR/WHITE-BLACK (18G-40")
6) GRIS-BLANC/GREY-WHITE (18G-38")
7) MAUVE-BLANC/PURPLE-WHITE (18G-36")
8) NOIR-BLANC/BLACK-WHITE (18G-26")

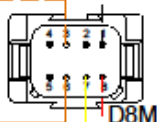
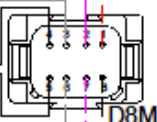
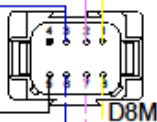
12 1) NOIR-BLANC/BLACK-WHITE (18G-44")
2) BOUCHON/PLUG
3) BRUN-BLANC/BROWN-WHITE (18G-28")
4) BOUCHON/PLUG
5) BOUCHON/PLUG
6) BRUN/BROWN (18G-28")
7) JAUNE-NOIR/YELLOW-BLACK (18G-44")
8) ROUGE-BLANC/RED-WHITE (18G-44")

315322

- 29) JAUNE-NOIR/YELLOW-BLACK (18G-12")
- 35) BLANC/WHITE (18G-12")
- 36) BLANC-NOIR/WHITE-BLACK (18G-12")
- 37) GRIS/GREY (18G-12")
- 38) GRIS-BLANC/GREY-WHITE (18G-12")
- 39) MAUVE/PURPLE (18G-12")

- 40) MAUVE-BLANC/PURPLE-WHITE (18G-12")
- 41) BLEU/BLUE (18G-12")
- 42) BLEU-BLANC/BLUE-WHITE (18G-12")
- 43) ROSE/PINK (18G-12")
- 44) ROSE-BLANC/PINK-WHITE (18G-12")
- 45) JAUNE/YELLOW (18G-12")
- 46) JAUNE-BLANC/YELLOW-WHITE (18G-12")

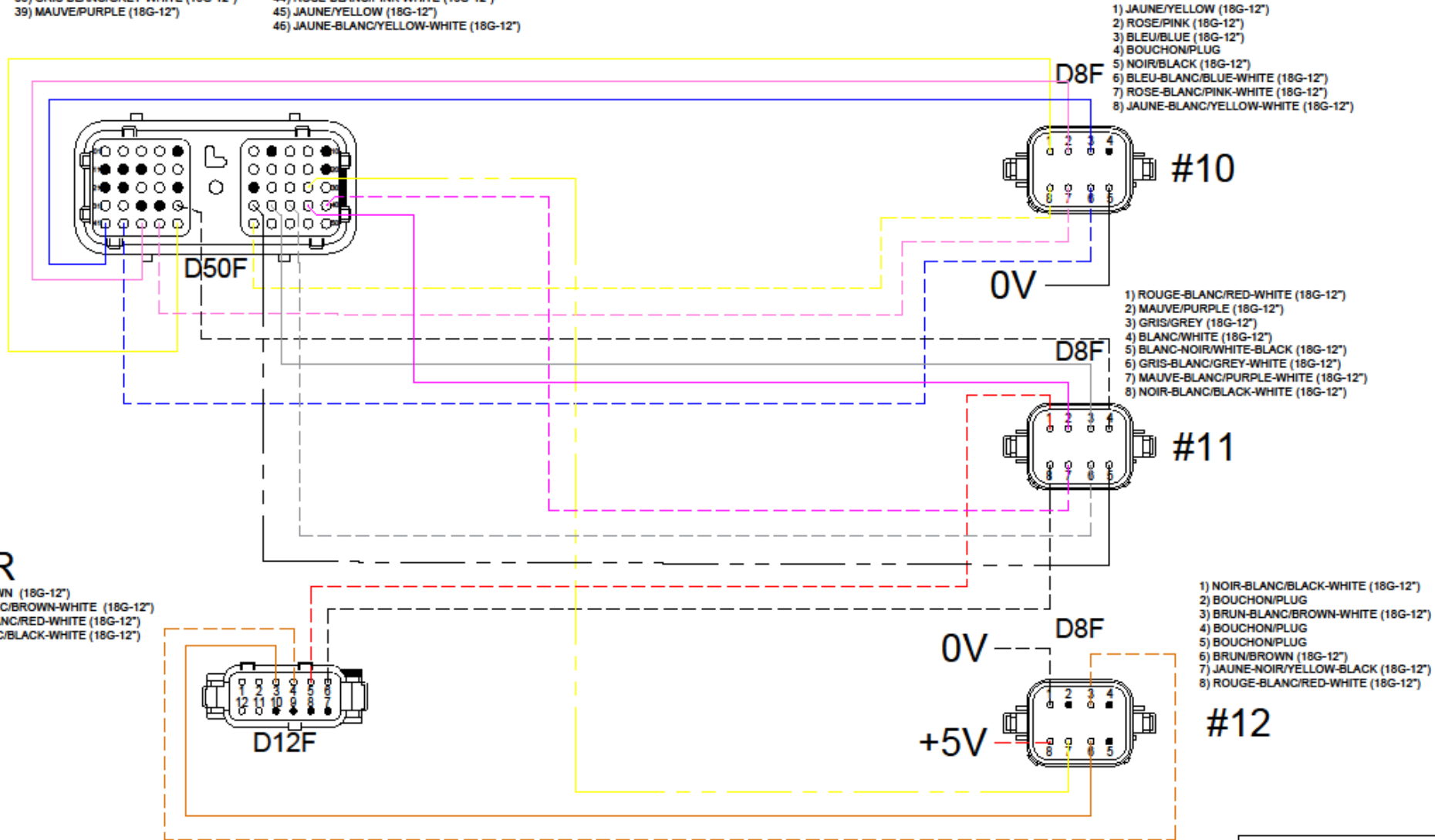

315322



MAINTIEN SEQUENCE

- A) JAUNE-BLANC/YELLOW-WHITE (18G-12")
- B) NOIR/BLACK (18G-6")
- C) VERT/GREEN (18G-12")

TEMP

- 1) NOIR-BLANC/BLACK-WHITE (18G-6")
- 2) ORANGE-BLANC/ORANGE-WHITE (18G-12")
- 3) VERT/GREEN (18G-12")
- 4) ROUGE/RED (18G-6")

PT-PINCE

- 1) NOIR-BLANC/BLACK-WHITE (18G-6.25")
- 2) ROUGE-BLANC/RED-WHITE (18G-6.25")
- 3) BOUCHON/PLUG
- 4) BRUN/BROWN (18G-12")

- 06) VERT/GREEN (18G-12")
- 14) MAUVE/PURPLE (18G-12")
- 15) ROSE/PINK (18G-12")
- 16) JAUNE-NOIR/YELLOW-BLACK (18G-12")
- 17) ORANGE/ORANGE (18G-12")
- 24) GRIS/GREY (18G-12")
- 27) ORANGE-BLANC/ORANGE-WHITE (18G-12")
- 28) BRUN/BROWN (18G-12")
- 31) VERT/GREEN (18G-12")
- 32) JAUNE-BLANC/YELLOW-WHITE (18G-12")

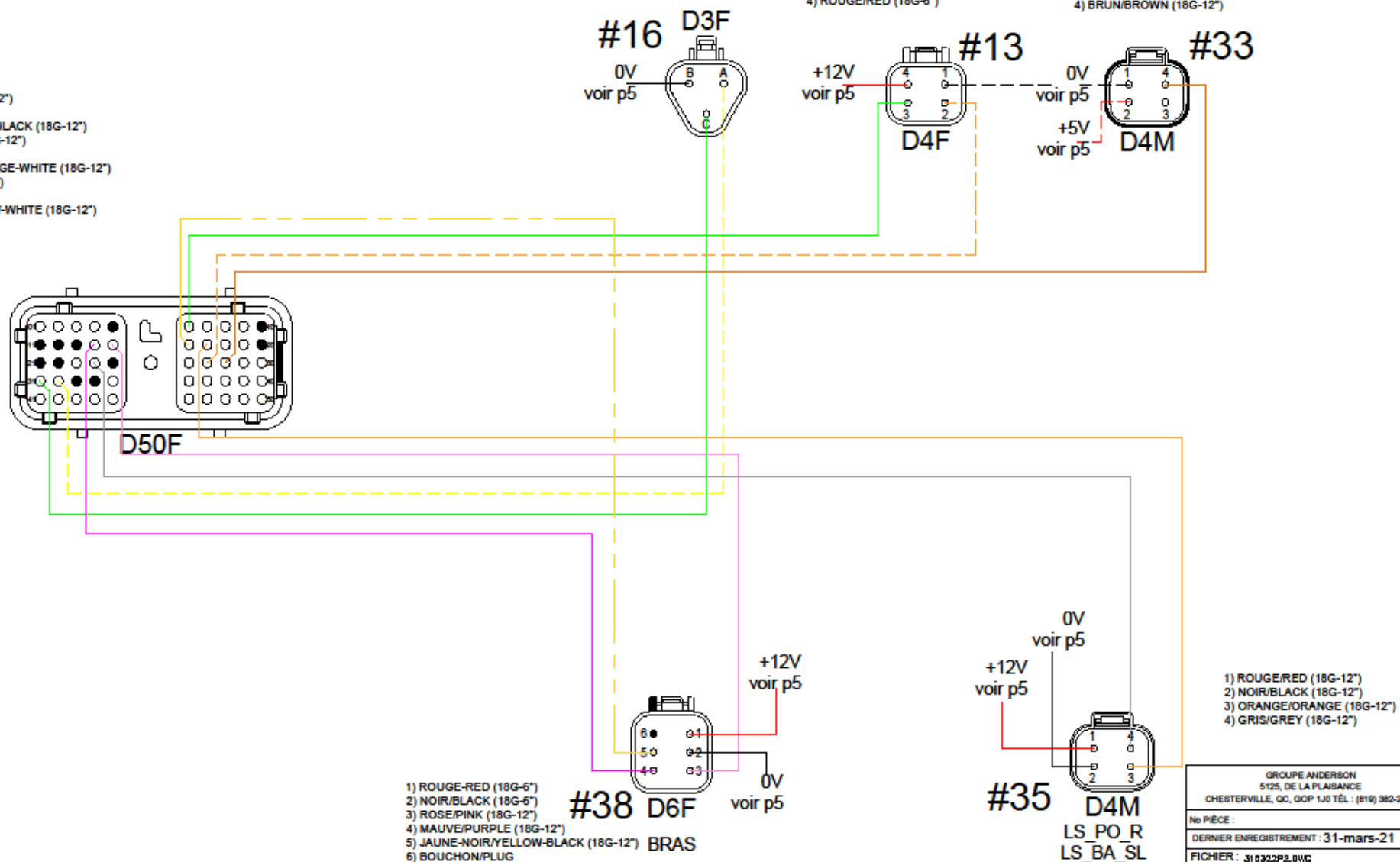

GRUPE ANDERSON
5125, DE LA PLAISANCE
CHESTERTVILLE, QC, GOP 1J0 TEL : (819) 382-2952

No PIÈCE :
DERNIER ENREGISTREMENT : 31-mars-21
FICHER : 31 5322P2.DWG

315322



- 1) JAUNE/YELLOW (18G-12")
- 2) BLEU-BLANC/BLUE-WHITE (18G-12")

NOIR

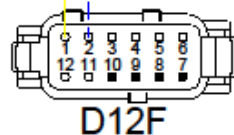

- 18) BLANC/WHITE (18G-12")
- 19) BLEU/BLUE (18G-12")
- 23) MAUVE/PURPLE (18G-12")
- 30) ORANGE/ORANGE (18G-12")

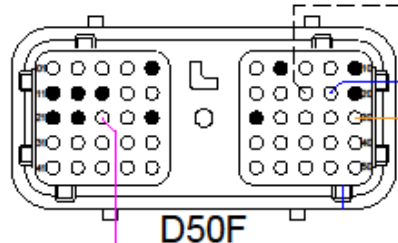

- 12) GRIS/GREY (18G-12")

GRIS

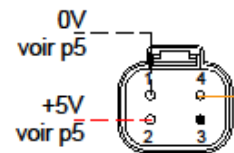
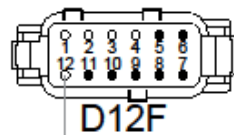

#32

PT_SL_A

- 1) NOIR-BLANC/BLACK-WHITE (18G-6")
- 2) ROUGE-BLANC/RED-WHITE (18G-6")
- 3) BOUCHON/PLUG
- 4) ORANGE/ORANGE (18G-12")

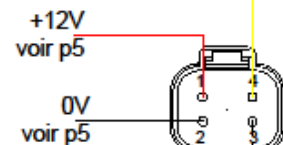

- 1) ROUGE/RED (18G-6")
- 2) NOIR/BLACK (18G-6")
- 3) BLANC (18G-12")
- 4) JAUNE/YELLOW (18G-12")

LS_TS #26
LS_SL_B

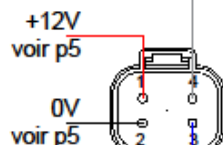

#23

LS_DP_B

- 1) ROUGE/RED (18G-6")
- 2) NOIR/BLACK (18G-6")
- 3) BLEU/BLUE (18G-12")
- 4) GRIS/GREY (18G-12")

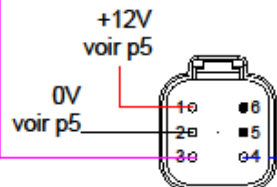

LS_DP_M #19

- 1) ROUGE/RED (18G-6")
- 2) NOIR/BLACK (18G-6")
- 3) MAUVE/PURPLE (18G-12")
- 4) BLEU-BLANC/BLUE-WHITE (18G-12")
- 5) BOUCHON/PLUG
- 6) BOUCHON/PLUG

GROUPE ANDERSON 5125, DE LA PLAISANCE CHESTERVILLE, QC, G0P 1J0 TEL : (819) 382-2952
No PIÈCE :
DERNIER ENREGISTREMENT : 2-nov.-20
FICHER : 310322P3.DWG

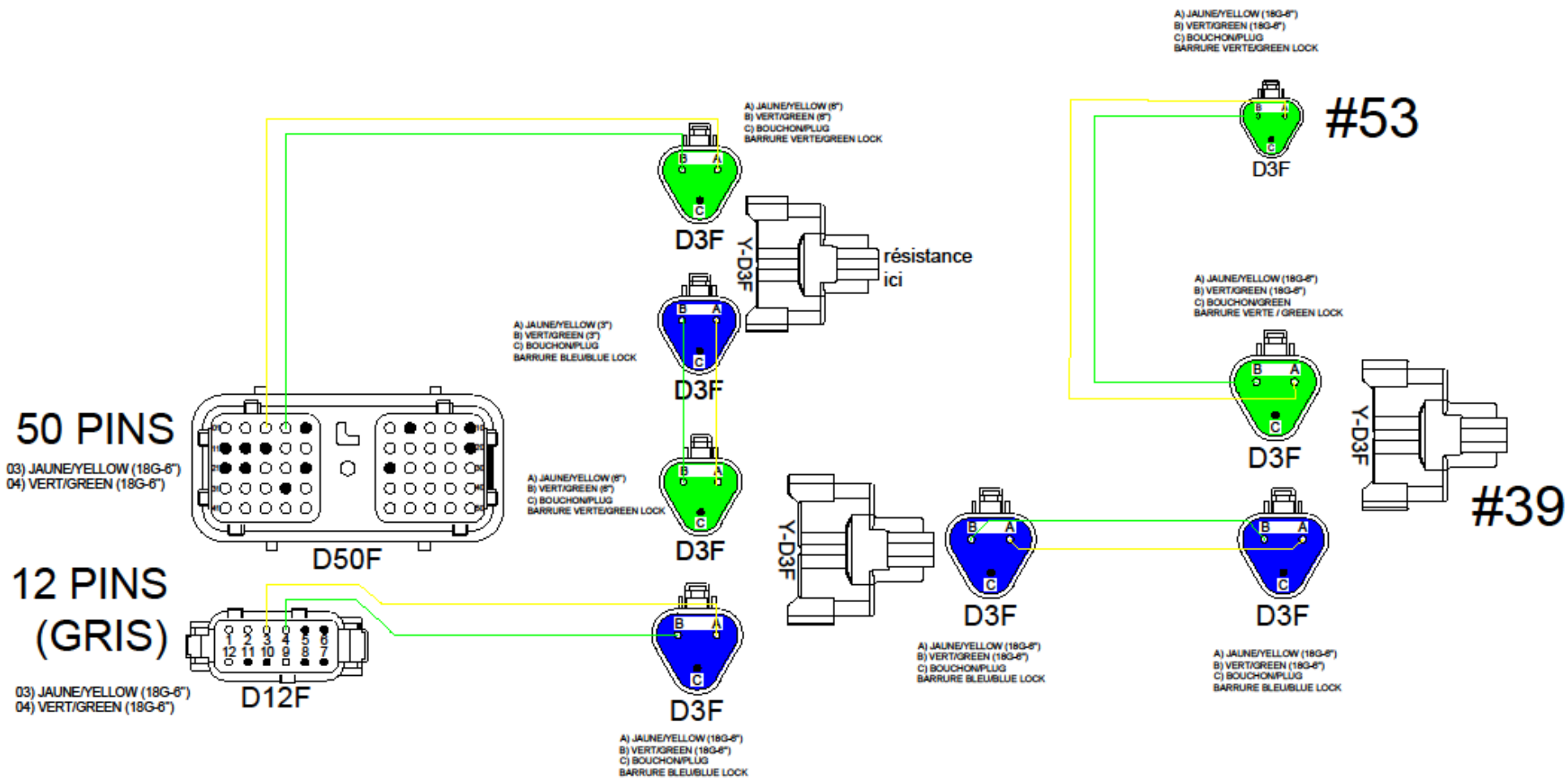

315322



- 1) NOIR/BLACK (18G-4')
- 2) ROUGE/RED (18G-4')
- 3) ROUGE-BLANC/RED-WHITE (18G-4')
- 4) NOIR-BLANC/BLACK-WHITE (18G-4')
- 47) ROUGE/RED (18G-4')
- 48) ROUGE/RED (18G-4')
- 49) ROUGE/RED (18G-4')
- 50) ROUGE/RED (18G-4')

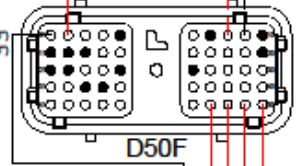

- 5) NOIR/BLACK (18G-4')
- 1) NOIR-BLANC/BLACK-WHITE (18G-4')
- 2) ROUGE-BLANC/RED-WHITE (18G-4')
- PT_PINCE
- PT_SL_A
- TEMP
- 1) NOIR-BLANC/BLACK-WHITE (18G-4')
- 2) ROUGE-BLANC/RED-WHITE (18G-4')
- 1) NOIR-BLANC/BLACK-WHITE (18G-4')
- 2) ROUGE-BLANC/RED-WHITE (18G-4')
- 1) NOIR-BLANC/BLACK-WHITE (18G-4')
- 2) ROUGE-BLANC/RED-WHITE (18G-4')
- 4) ROUGE/RED (18G-4')

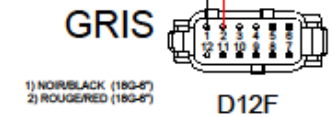
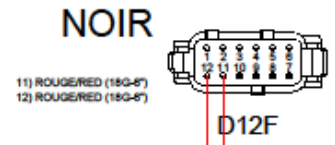
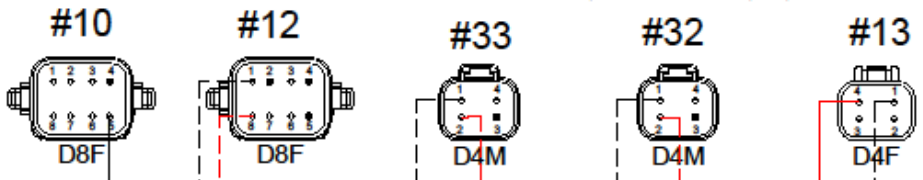

ROUGE 3"

NOIR 3"

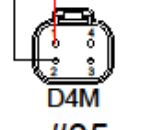
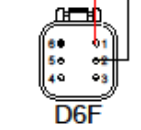
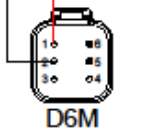
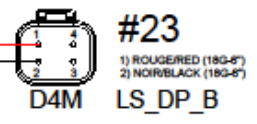

GROUPE ANDERSON 5125, DE LA PLAISANCE CHESTERTVILLE, QC, G0P 1J0 TÉL. : (819) 382-2952	
No PIÈCE : 315322	
DERNIER ENREGISTREMENT : 29-oct.-20	
FICHER : 310322P5.DWG	

315323

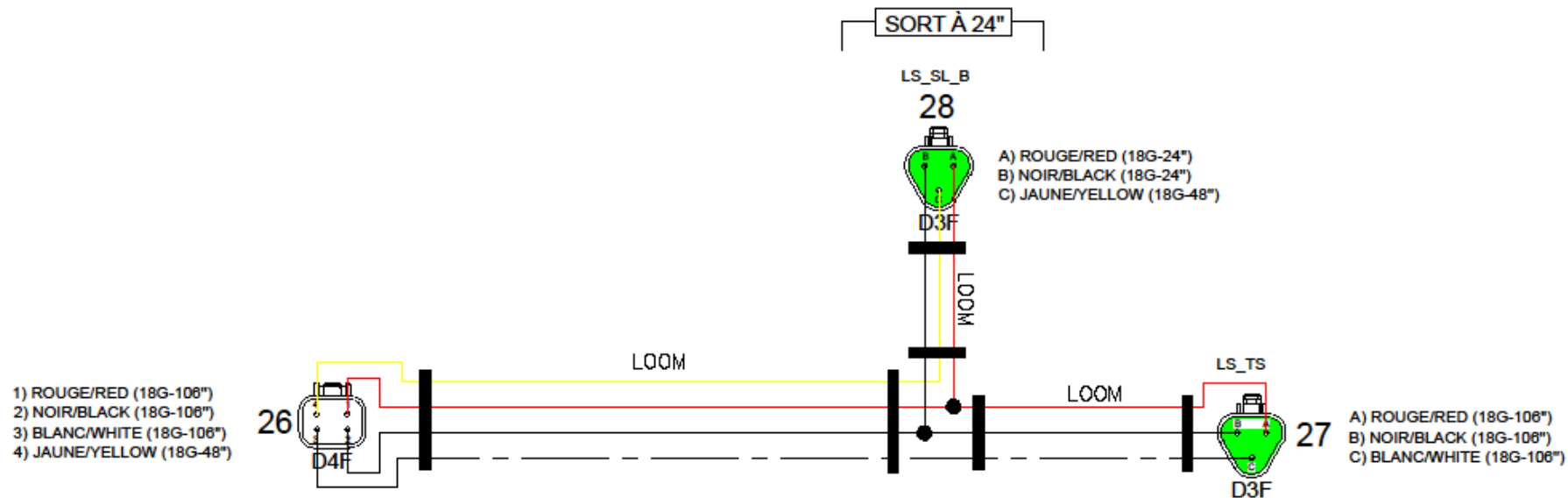

GRUPE ANDERSON 5125, DE LA PLAISANCE CHESTERVILLE, QC, G0P 1J0 TEL : (514) 382-2952
No PIÈCE :
DERNIER ENREGISTREMENT : 31-mars-21
FICHER : 31 0323.DWG