



# STACKPRO 5400

Electric Diagram / Diagramme Électrique

To navigate the electric diagram, you can click on the **red rectangle** that identify the wiring section you want to look up, click on the

**Back**

button to go back to the main section.

Pour naviguer dans le schéma électrique, vous pouvez cliquer sur les **rectangles rouges** qui identifie la section du câblage que vous souhaitez regarder, cliquez sur le bouton

**Back**

pour revenir à la section principale.

# DIAGRAMME ÉLECTRIQUE/ELECTRIC DIAGRAM – STACKPRO 5400

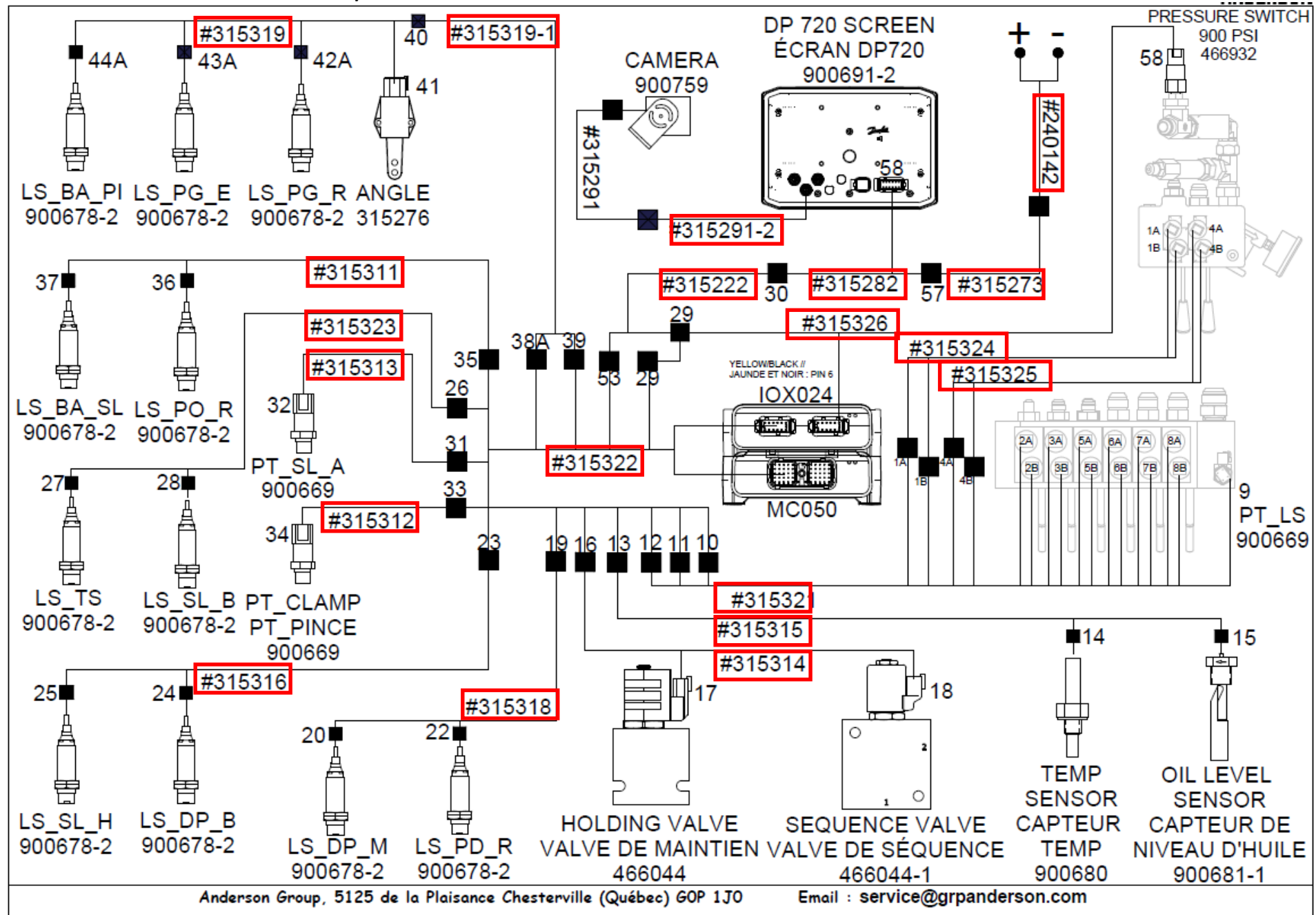

240142

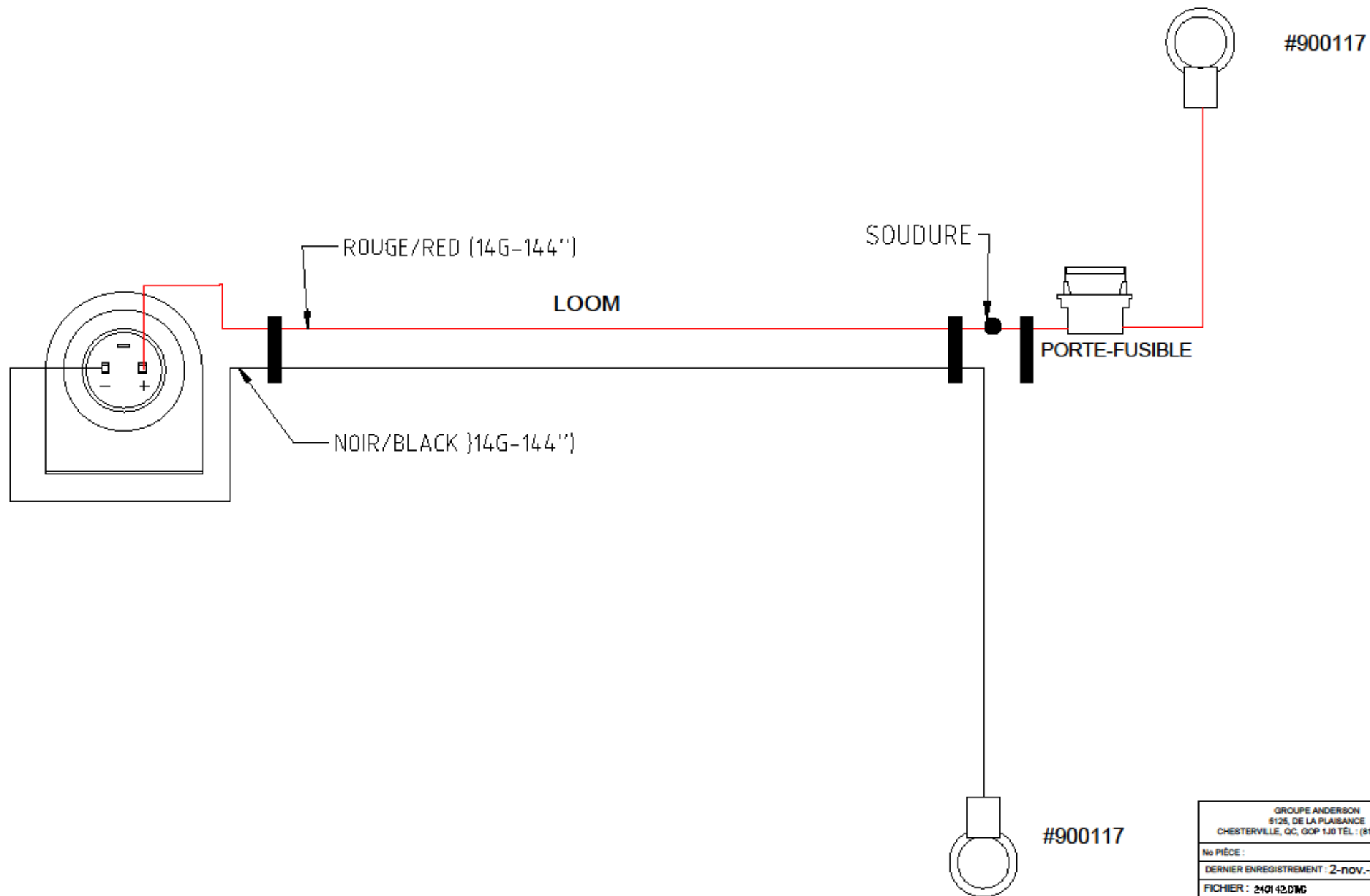

GRUPE ANDERSON 5125, DE LA PLAISANCE CHESTERVILLE, QC, G0P 1J0 TEL : (819) 382-2952
No PIÈCE :
DERNIER ENREGISTREMENT : 2-nov.-20
FICHER : 240142.DWG

315222

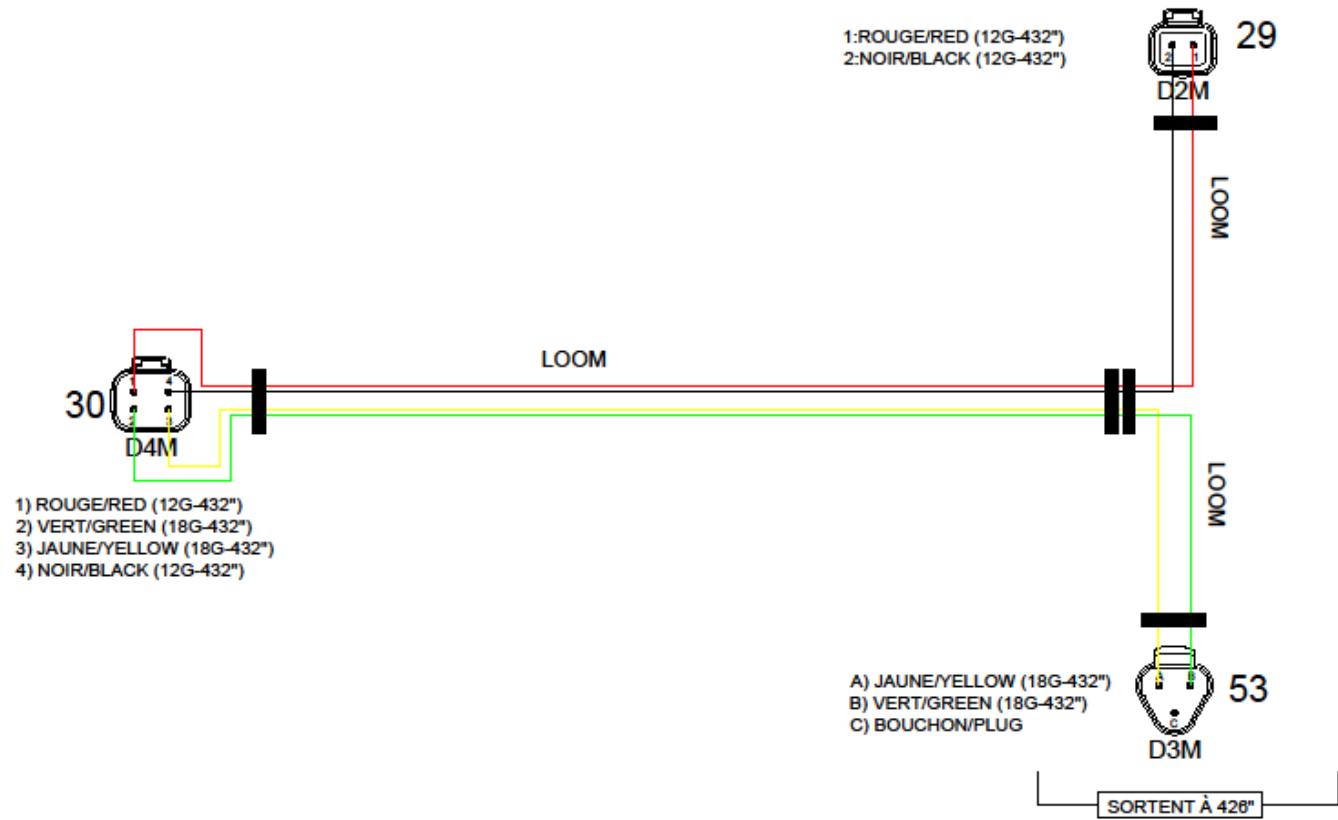

GRUPE ANDERSON 5125, DE LA PLAISANCE CHESTERVILLE, QC, G0P 1J0 TÉL. : (514) 382-2952
No PIÈCE :
DERNIER ENREGISTREMENT : 1-déc.-20
FICHER :

315273

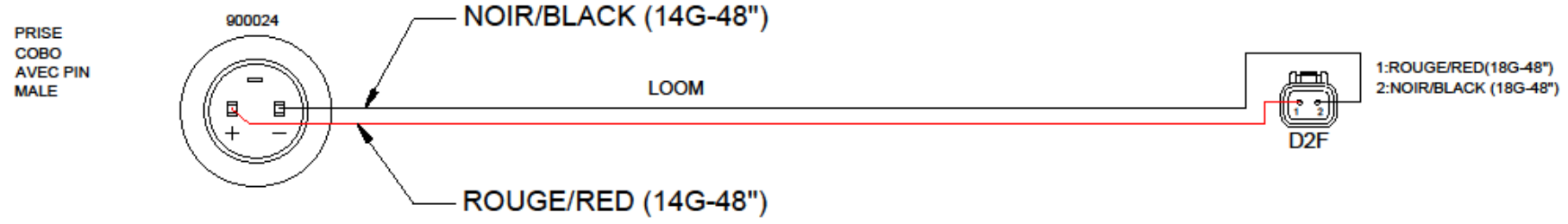

GRUPE ANDERSON 5125, DE LA PLAISANCE CHESTERVILLE, QC, G0P 1J0 TÉL. : (514) 382-2952
No PIÈCE :
DERNIER ENREGISTREMENT : 31-mars-21
FICHER : 31 0273.01WC

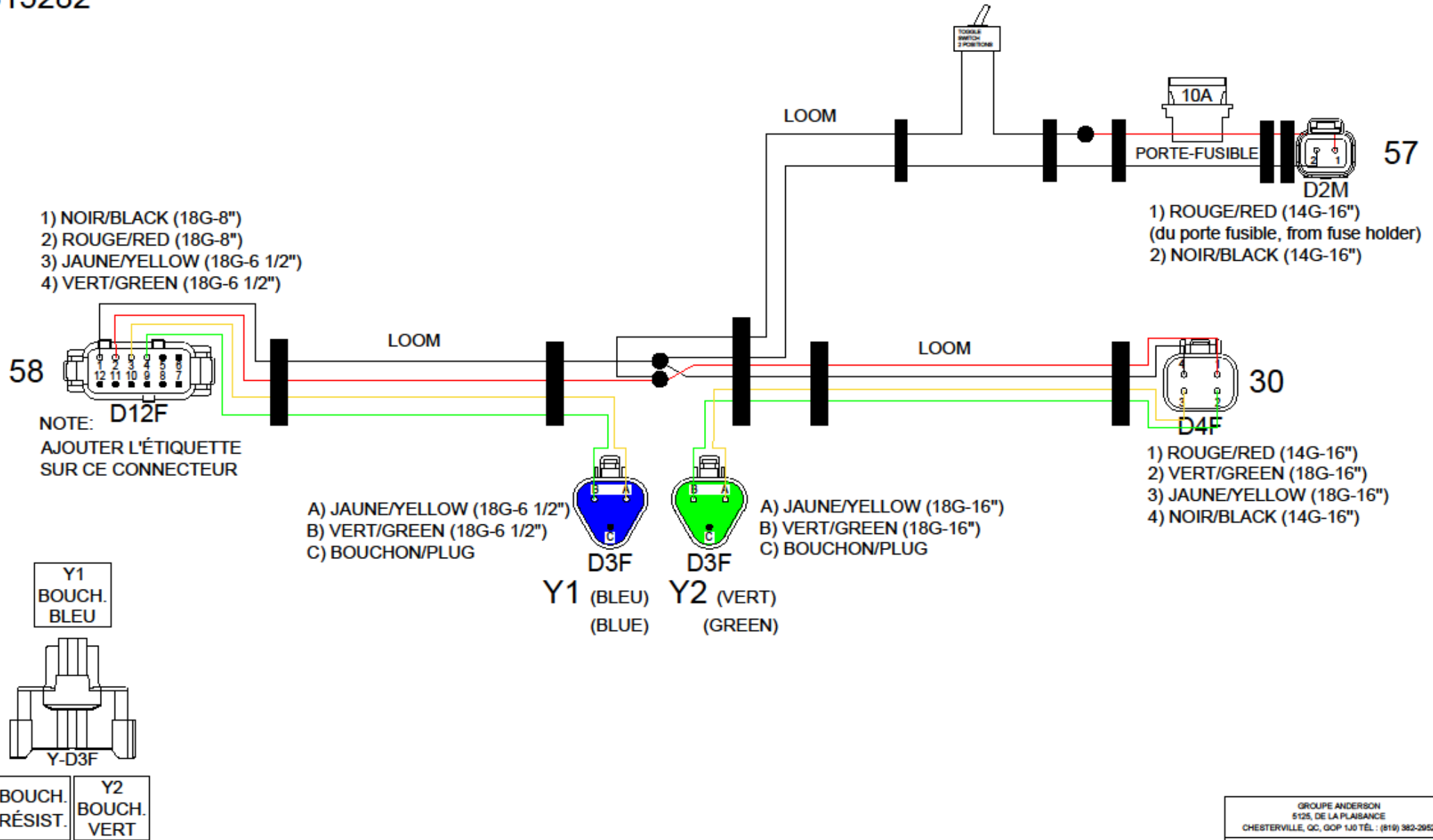

315291-2



\*\*\* LONGUEUR TOTALE DU FIL = 28"  
TOTAL WIRE LENGTH

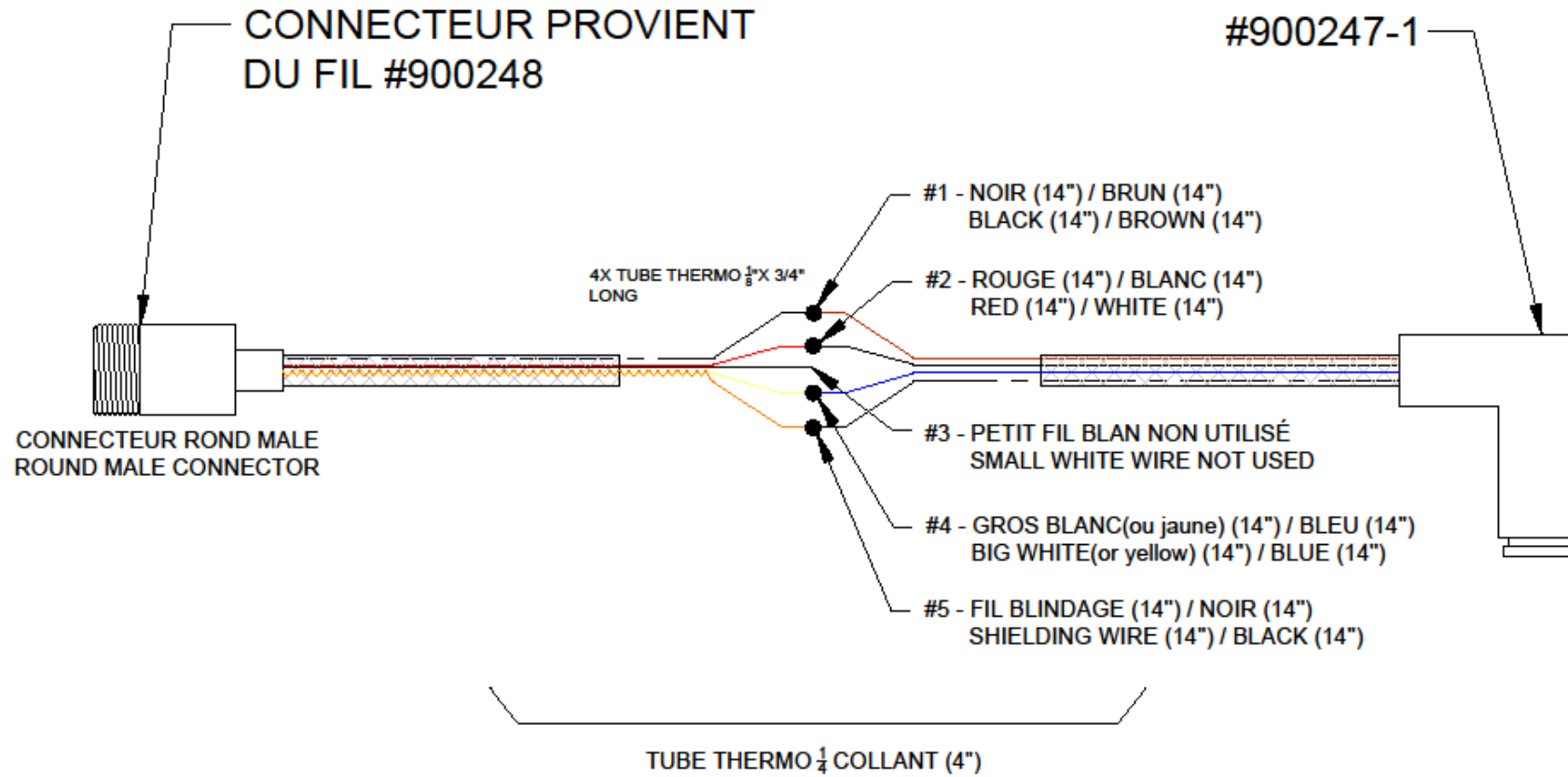

GRUPE ANDERSON 5125, DE LA PLAISANCE CHESTERVILLE, QC, G0P 1J0 TEL : (514) 382-2952
No PIÈCE :
DERNIER ENREGISTREMENT : 31-mars-21
FICHER : 074-FL 315291-2.0100

315311

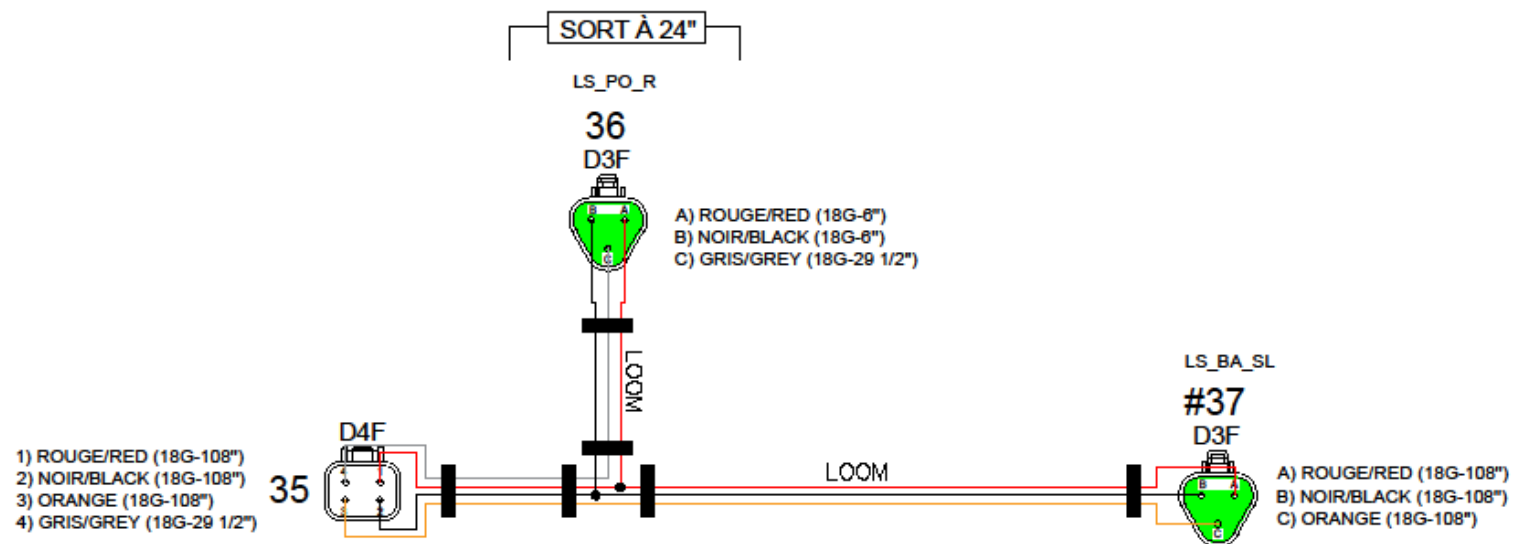

GRUPE ANDERSON 5125, DE LA PLAISANCE CHESTERVILLE, QC, G0P 1J0 TÈL : (819) 382-2952
No PIÈCE :
DERNIER ENREGISTREMENT : 28-sept-22
FICHER : 310311.DWG



315312



- 1) NOIR-BLANC (18G-30")  
BLACK-WHITE
- 2) ROUGE-BLANC (18G-30")  
RED-WHITE
- 3) BOUCHON/PLUG
- 4) BRUN/BROWN (18G-30")

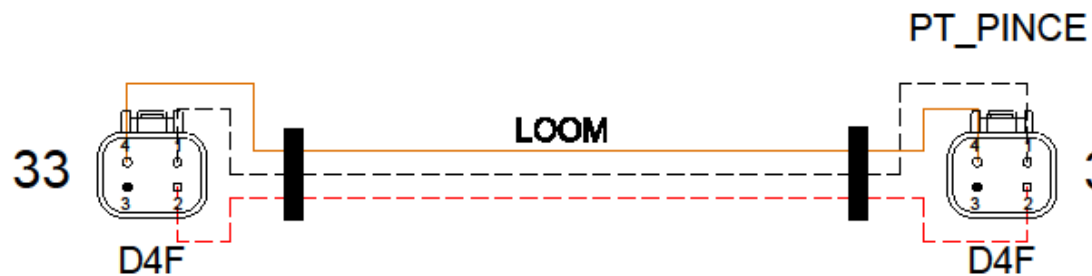

- 1) NOIR-BLANC (18G-30")  
BLACK-WHITE
- 2) ROUGE-BLANC (18G-30")  
RED-WHITE
- 3) BOUCHON/PLUG
- 4) BRUN/BROWN (18G-30")

GRUPE ANDERSON 5125, DE LA PLAISANCE CHESTERVILLE, QC, QOP 1J0 TEL : (514) 383-2952
No PIÈCE :
DERNIER ENREGISTREMENT : 11-mai-20
FICHER : 2002.DWG

315313



- 1) NOIR-BLANC (18G-46")  
BLACK-WHITE
- 2) ROUGE-BLANC (18G-46")  
RED-WHITE
- 3) BOUCHON/PLUG
- 4) ORANGE (18G-46")

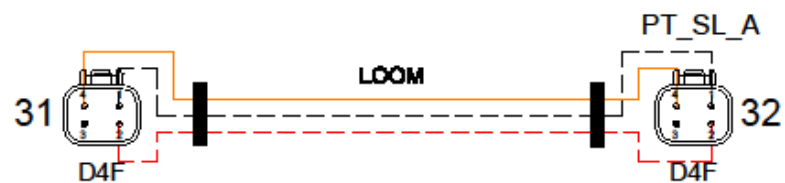

- 1) NOIR-BLANC (18G-46")  
BLACK-WHITE
- 2) ROUGE-BLANC (18G-46")  
RED-WHITE
- 3) BOUCHON/PLUG
- 4) ORANGE (18G-46")

GRUPE ANDERSON 5125, DE LA PLAISANCE CHESTERVILLE, QC, GOP 1J0 T�L : (819) 382-2952
No PI�CE :
DERNIER ENREGISTREMENT : 11-mai-20
FICHER : 20000.DWG

315314

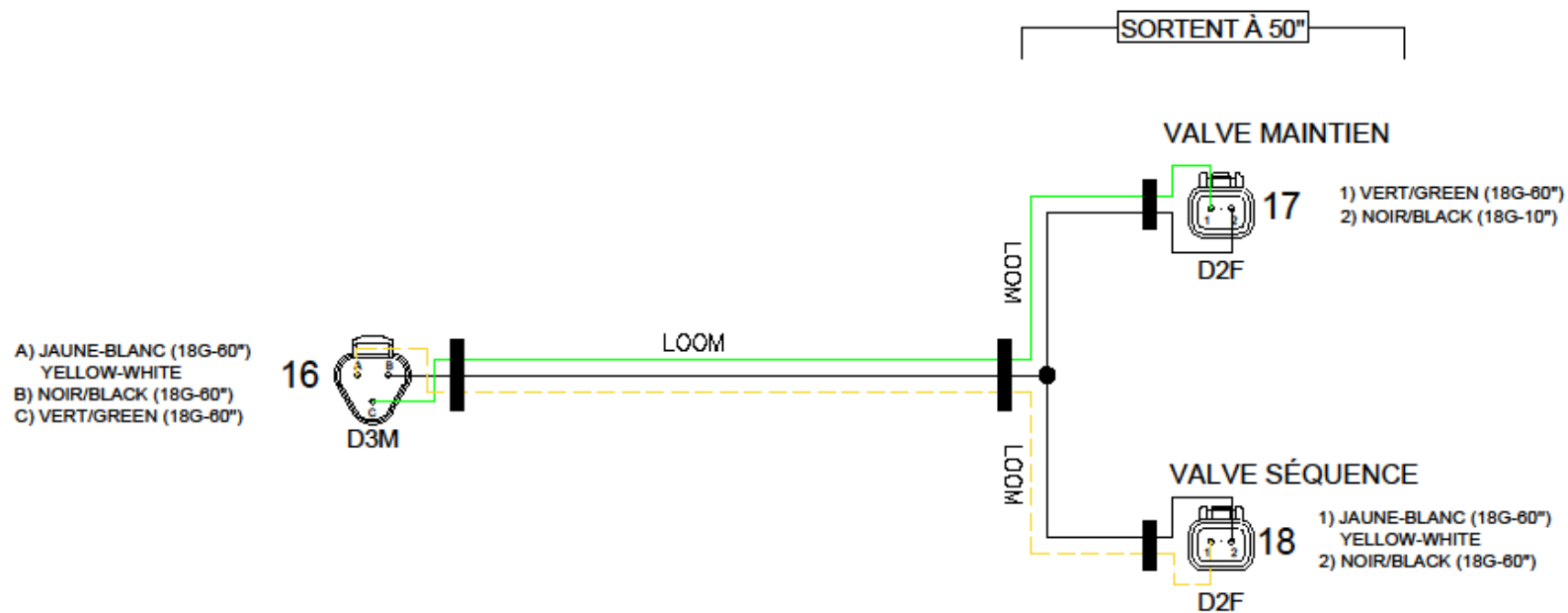

GRUPE ANDERSON 5125, DE LA PLAISANCE CHESTERVILLE, QC, GOP 1J0 TEL : (819) 382-2952
No PIÈCE :
DERNIER ENREGISTREMENT : 31-mars-21
FICHER : 310314.DWG

315315

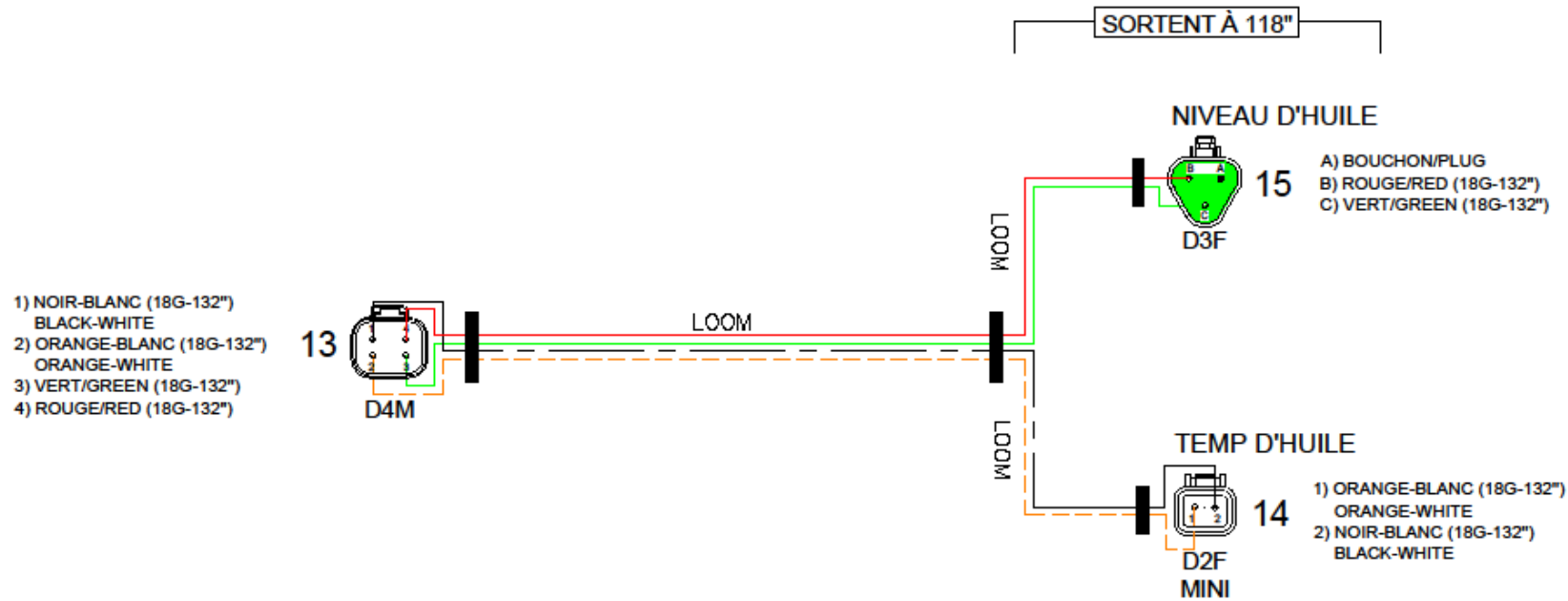

GRUPE ANDERSON 5125, DE LA PLAISANCE CHESTERVILLE, QC, G0P 1J0 TÉL. : (819) 382-2952
No PIÈCE :
DERNIER ENREGISTREMENT : 29-oct.-20
FICHER : 310315.DWG

315316

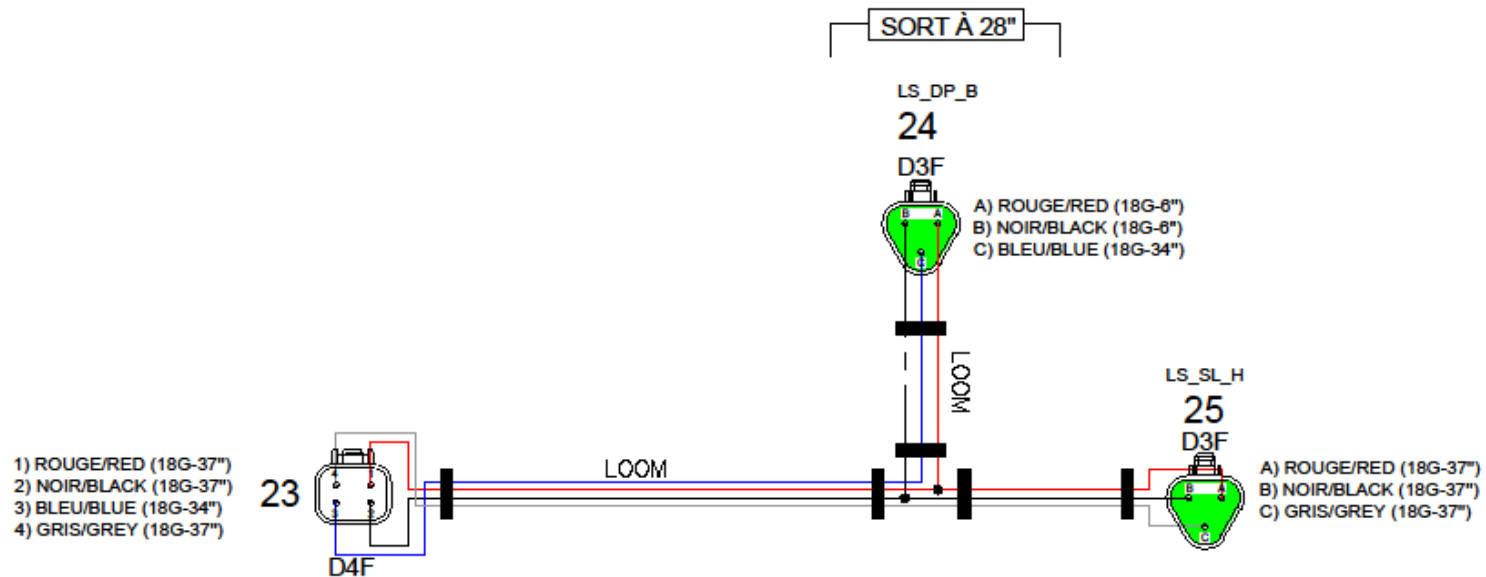

GRUPE ANDERSON 5125, DE LA PLAISANCE CHESTERVILLE, QC, G0P 1J0 TÉL. : (514) 382-2952
No PIÈCE :
DERNIER ENREGISTREMENT : 31-mars-21
FICHER : 31 031BLDWC

315318

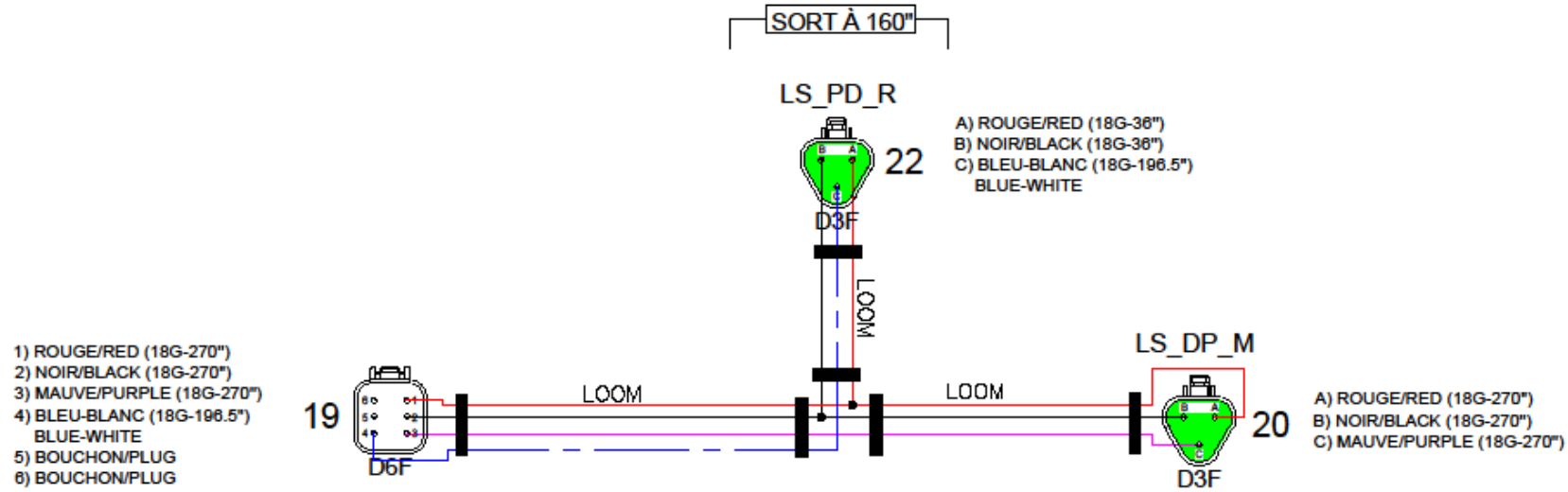

GRUPE ANDERSON 5125, DE LA PLAISANCE CHESTERVILLE, QC, QOP 1J0 TÉL : (514) 382-2952
No PIÈCE :
DERNIER ENREGISTREMENT : 21-sept-22
FICHIER : 315318.DWG

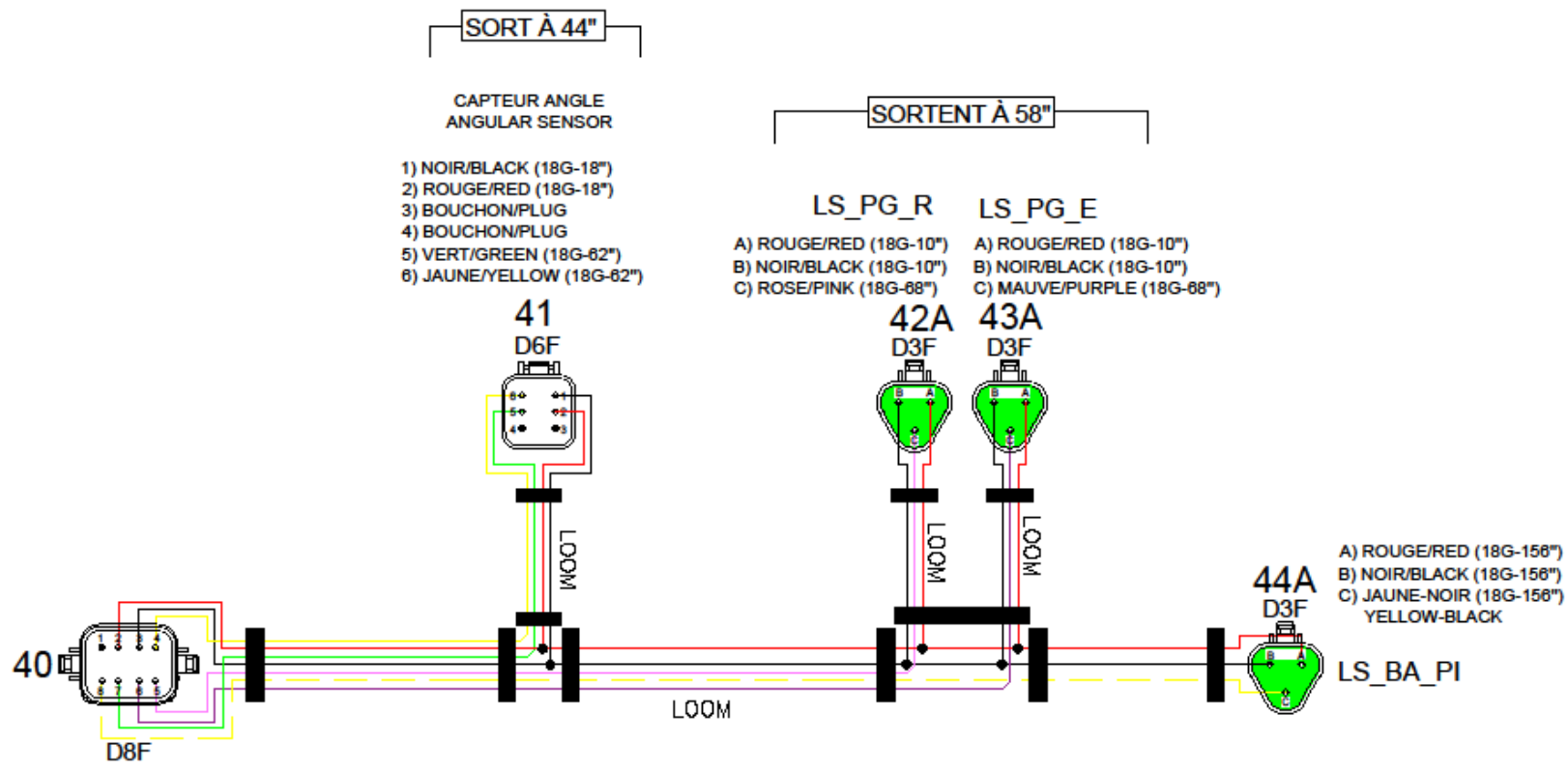

315319-1



- 1) BOUCHON/PLUG
- 2) ROUGE/RED (18G-110")
- 3) NOIR/BLACK (18G-110")
- 4) JAUNE/YELLOW (18G-110")
- 5) ROSE/PINK (18G-110")
- 6) MAUVE/PURPLE (18G-110")
- 7) VERT/GREEN (18G-110")
- 8) JAUNE-NOIR (18G-110")  
YELLOW-BLACK

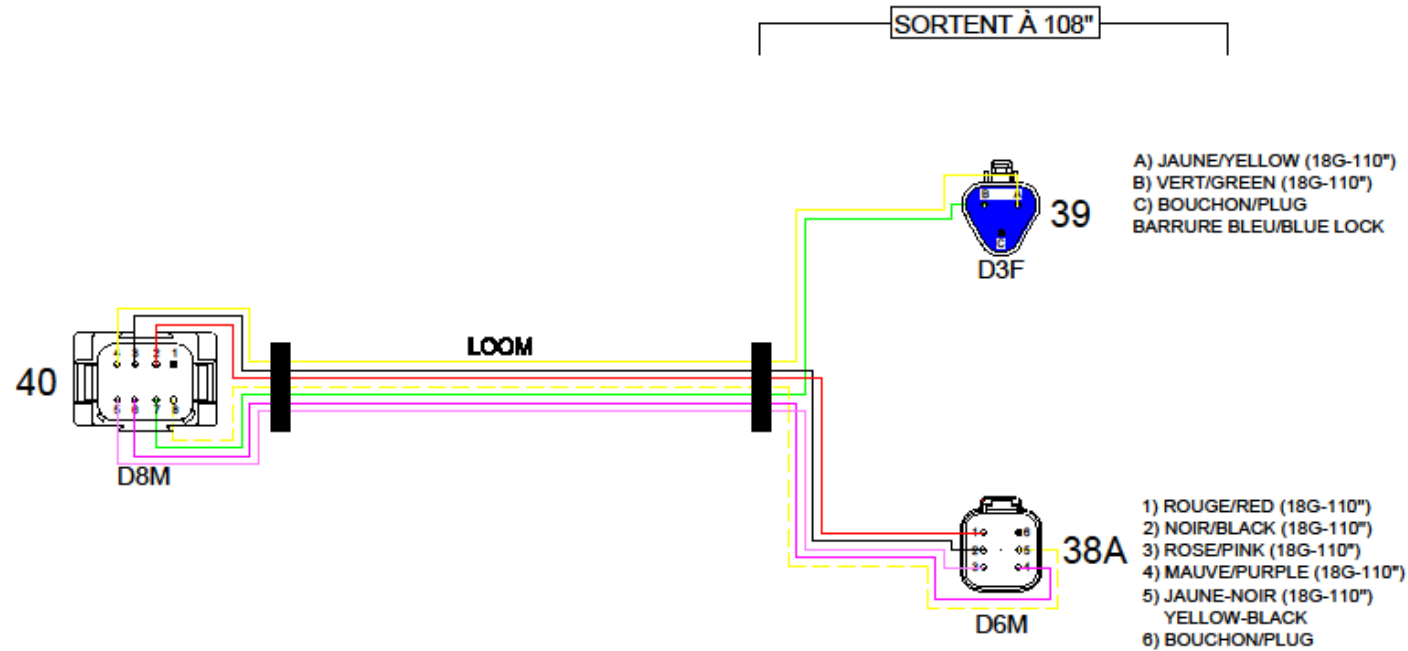

GRUPE ANDERSON 5125, DE LA PLAISANCE CHESTERVILLE, QC, G0P 1J0 TEL : (514) 382-2952
No PIÈCE :
DERNIER ENREGISTREMENT : 10-juin-20
FICHER : 315319-1.DWG



**315321**

**1A** 1) ROUGE-BLANC (18G-26")  
RED-WHITE  
2) NOIR/BLACK (18G-6 1/2")

**1B** 1) NOIR-BLANC (18G-26")  
BLACK-WHITE  
2) NOIR/BLACK (18G-6 1/2")

SORTENT À 20"

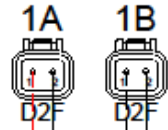

**3A** 1) JAUNE/YELLOW (18G-30")  
2) NOIR/BLACK (18G-6 1/2")

**3B** 1) JAUNE-BLANC (18G-30")  
YELLOW-WHITE  
2) NOIR/BLACK (18G-6 1/2")

SORTENT À 24"

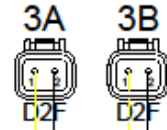

**5A** 1) BLEU/BLUE (18G-34")  
2) NOIR/BLACK (18G-6 1/2")

**5B** 1) BLEU-BLANC (18G-34")  
BLUE-WHITE  
2) NOIR/BLACK (18G-6 1/2")

SORTENT À 28"

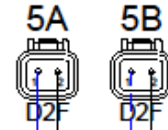

**7A** 1) GRIS/GREY (18G-38")  
2) NOIR/BLACK (18G-6 1/2")

**7B** 1) GRIS-BLANC (18G-38")  
GREY-WHITE  
2) NOIR/BLACK (18G-6 1/2")

SORTENT À 32"

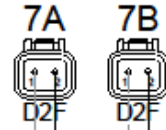

1) NOIR-BLANC (18G-44")  
BLACK-WHITE  
2) ROUGE-BLANC (18G-44")  
RED-WHITE  
3) BOUCHON/PLUG  
4) JAUNE-NOIR (18G-44")  
YELLOW-BLACK

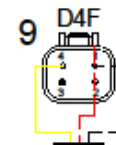

LOOM (16 X)

**2A** 1) BRUN/BROWN (18G-28")  
2) NOIR/BLACK (18G-6 1/2")

**2B** 1) BRUN-BLANC (18G-28")  
BROWN-WHITE  
2) NOIR/BLACK (18G-6 1/2")

SORTENT À 22"

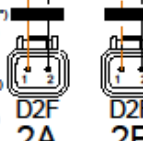

**4A** 1) ROSE/PINK (18G-32")  
2) NOIR/BLACK (18G-6 1/2")

**4B** 1) ROSE-BLANC (18G-32")  
PINK-WHITE  
2) NOIR/BLACK (18G-6 1/2")

SORTENT À 26"

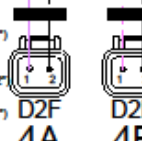

**6A** 1) MAUVE/PURPLE (18G-36")  
2) NOIR/BLACK (18G-6 1/2")

**6B** 1) MAUVE-BLANC (18G-36")  
PURPLE-WHITE  
2) NOIR/BLACK (18G-6 1/2")

SORTENT À 30"

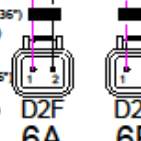

**8A** 1) BLANC/WHITE (18G-40")  
2) NOIR/BLACK (18G-40")

**8B** 1) BLANC-NOIR (18G-40")  
WHITE-BLACK  
2) NOIR/BLACK (18G-40")

SORTENT À 33 1/2"

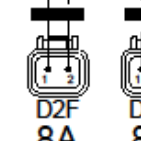

LOOM

**10** 1) JAUNE/YELLOW (18G-30")  
2) ROSE/PINK (18G-32")  
3) BLEU/BLUE (18G-34")  
4) BOUCHON/PLUG  
5) NOIR/BLACK (18G-40")  
6) BLEU-BLANC/BLUE-WHITE (18G-34")  
7) ROSE-BLANC/PINK-WHITE (18G-32")  
8) JAUNE-BLANC/YELLOW-WHITE (18G-30")

**11** 1) ROUGE-BLANC/RED-WHITE (18G-26")  
2) MAUVE/PURPLE (18G-36")  
3) GRIS/GREY (18G-38")  
4) BLANC/WHITE (18G-40")  
5) BLANC-NOIR/WHITE-BLACK (18G-40")  
6) GRIS-BLANC/GREY-WHITE (18G-38")  
7) MAUVE-BLANC/PURPLE-WHITE (18G-36")  
8) NOIR-BLANC/BLACK-WHITE (18G-26")

**12** 1) NOIR-BLANC/BLACK-WHITE (18G-44")  
2) BOUCHON/PLUG  
3) BRUN-BLANC/BROWN-WHITE (18G-28")  
4) BOUCHON/PLUG  
5) BOUCHON/PLUG  
6) BRUN/BROWN (18G-28")  
7) JAUNE-NOIR/YELLOW-BLACK (18G-44")  
8) ROUGE-BLANC/RED-WHITE (18G-44")

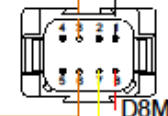
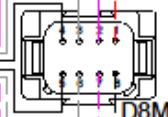
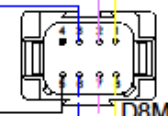

GRUPE ANDERSON  
5125, DE LA PLAISANCE  
CHESTERVILLE, QC, GOP 1J0 TEL : (819) 382-2952  
No PIÈCE :  
DERNIER ENREGISTREMENT : 11-mai-20  
FICHER : 310321.DWD

# 315322

- 29) JAUNE-NOIR/YELLOW-BLACK (18G-12")
- 35) BLANC/WHITE (18G-12")
- 36) BLANC-NOIR/WHITE-BLACK (18G-12")
- 37) GRIS/GREY (18G-12")
- 38) GRIS-BLANC/GREY-WHITE (18G-12")
- 39) MAUVE/PURPLE (18G-12")

- 40) MAUVE-BLANC/PURPLE-WHITE (18G-12")
- 41) BLEU/BLUE (18G-12")
- 42) BLEU-BLANC/BLUE-WHITE (18G-12")
- 43) ROSE/PINK (18G-12")
- 44) ROSE-BLANC/PINK-WHITE (18G-12")
- 45) JAUNE/YELLOW (18G-12")
- 46) JAUNE-BLANC/YELLOW-WHITE (18G-12")

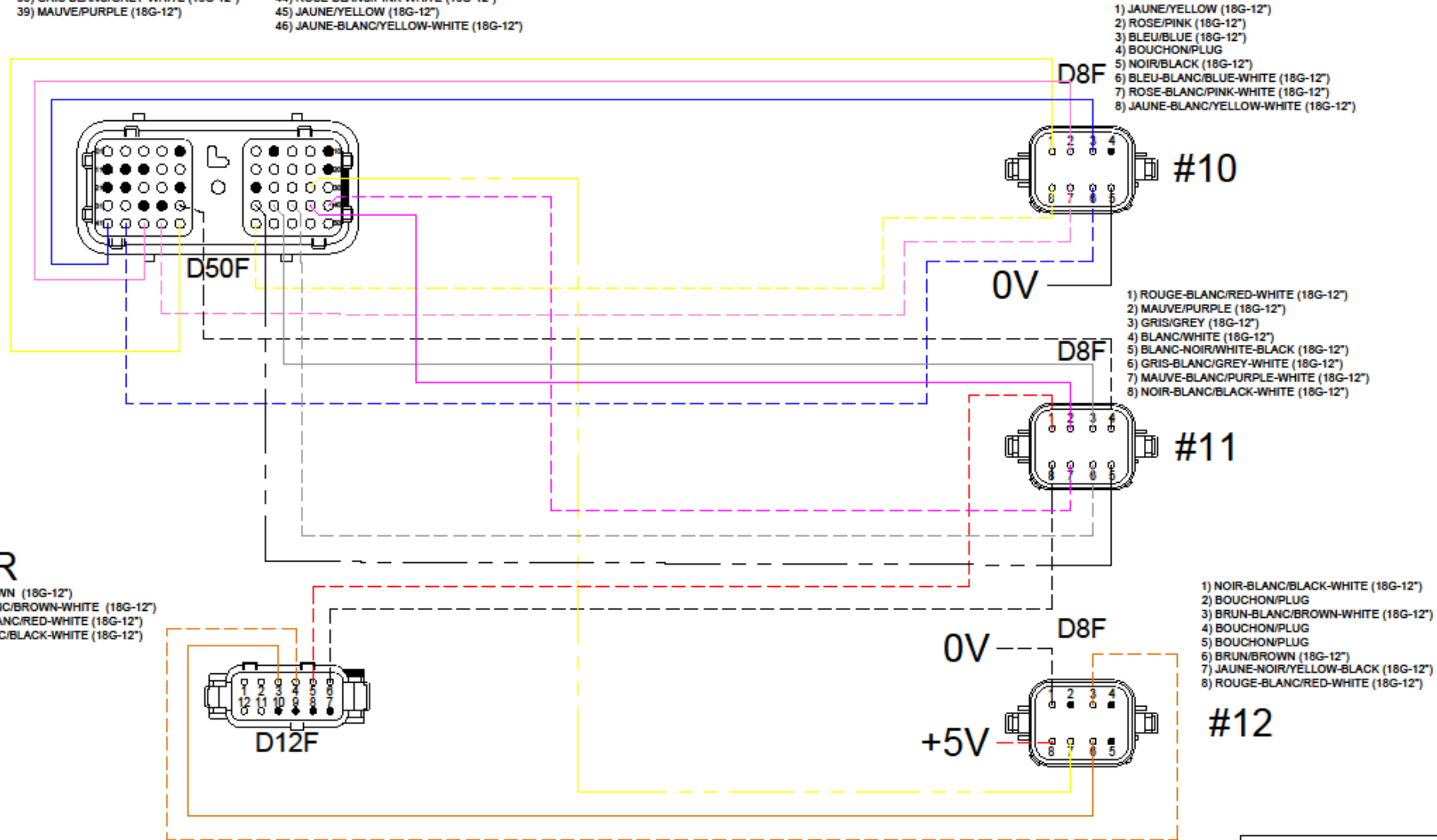

315322



MAINTIEN SEQUENCE

- A) JAUNE-BLANC/YELLOW-WHITE (18G-12")
- B) NOIR/BLACK (18G-6")
- C) VERT/GREEN (18G-12")

TEMP

- 1) NOIR-BLANC/BLACK-WHITE (18G-6")
- 2) ORANGE-BLANC/ORANGE-WHITE (18G-12")
- 3) VERT/GREEN (18G-12")
- 4) ROUGE/RED (18G-6")

PT-PINCE

- 1) NOIR-BLANC/BLACK-WHITE (18G-6.25")
- 2) ROUGE-BLANC/RED-WHITE (18G-6.25")
- 3) BOUCHON/PLUG
- 4) BRUN/BROWN (18G-12")

- 06) VERT/GREEN (18G-12")
- 14) MAUVE/PURPLE (18G-12")
- 15) ROSE/PINK (18G-12")
- 16) JAUNE-NOIR/YELLOW-BLACK (18G-12")
- 17) ORANGE/ORANGE (18G-12")
- 24) GRIS/GREY (18G-12")
- 27) ORANGE-BLANC/ORANGE-WHITE (18G-12")
- 28) BRUN/BROWN (18G-12")
- 31) VERT/GREEN (18G-12")
- 32) JAUNE-BLANC/YELLOW-WHITE (18G-12")

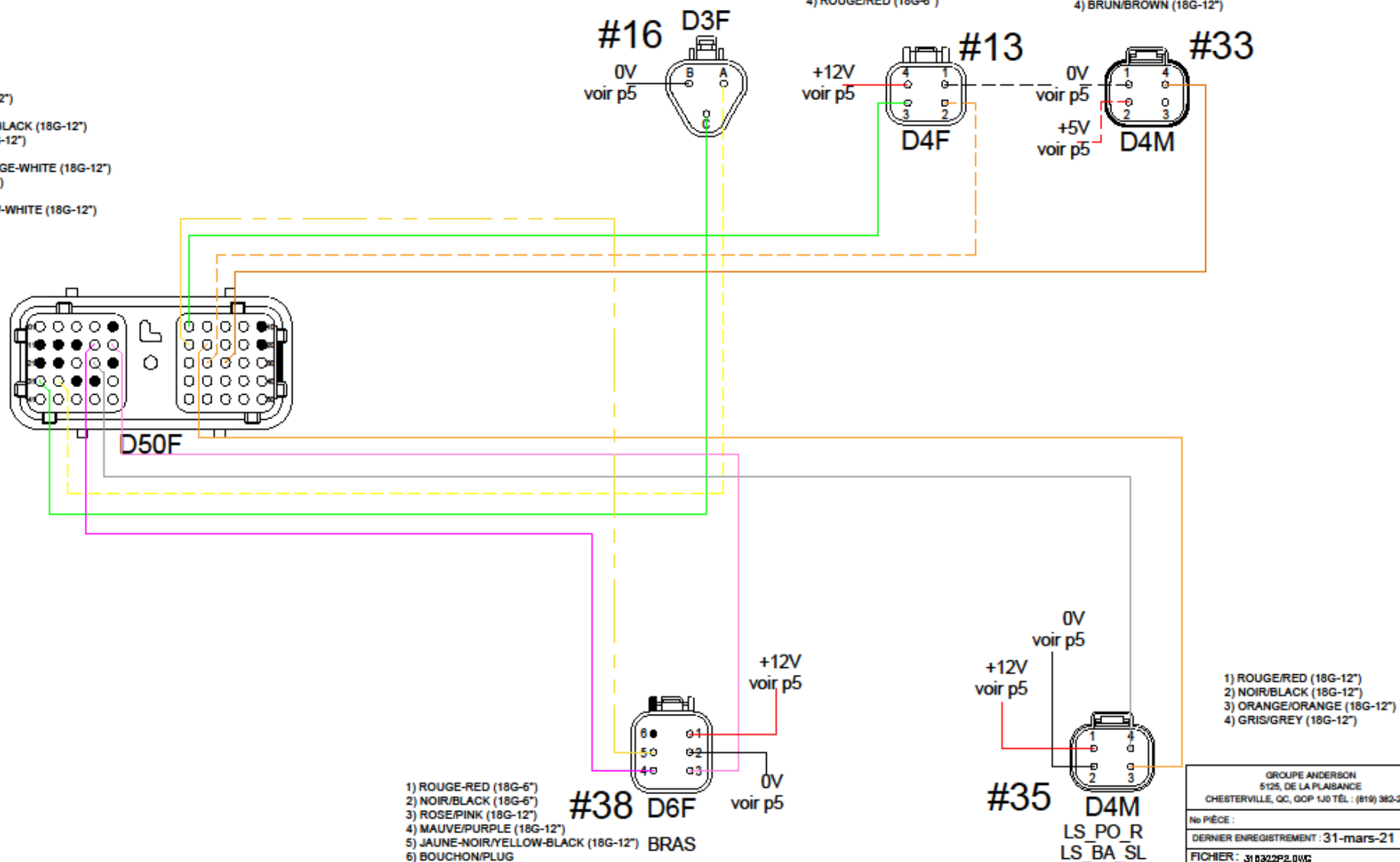

- 1) ROUGE/RED (18G-12")
- 2) NOIR/BLACK (18G-12")
- 3) ORANGE/ORANGE (18G-12")
- 4) GRIS/GREY (18G-12")

GROUPE ANDERSON  
 5125, DE LA PLAISANCE  
 CHESTERTVILLE, QC, G0P 1J0 TEL : (514) 382-2952  
 No PIÈCE :  
 DERNIER ENREGISTREMENT : 31-mars-21  
 FICHER : 31 5322P2.DWG

315322

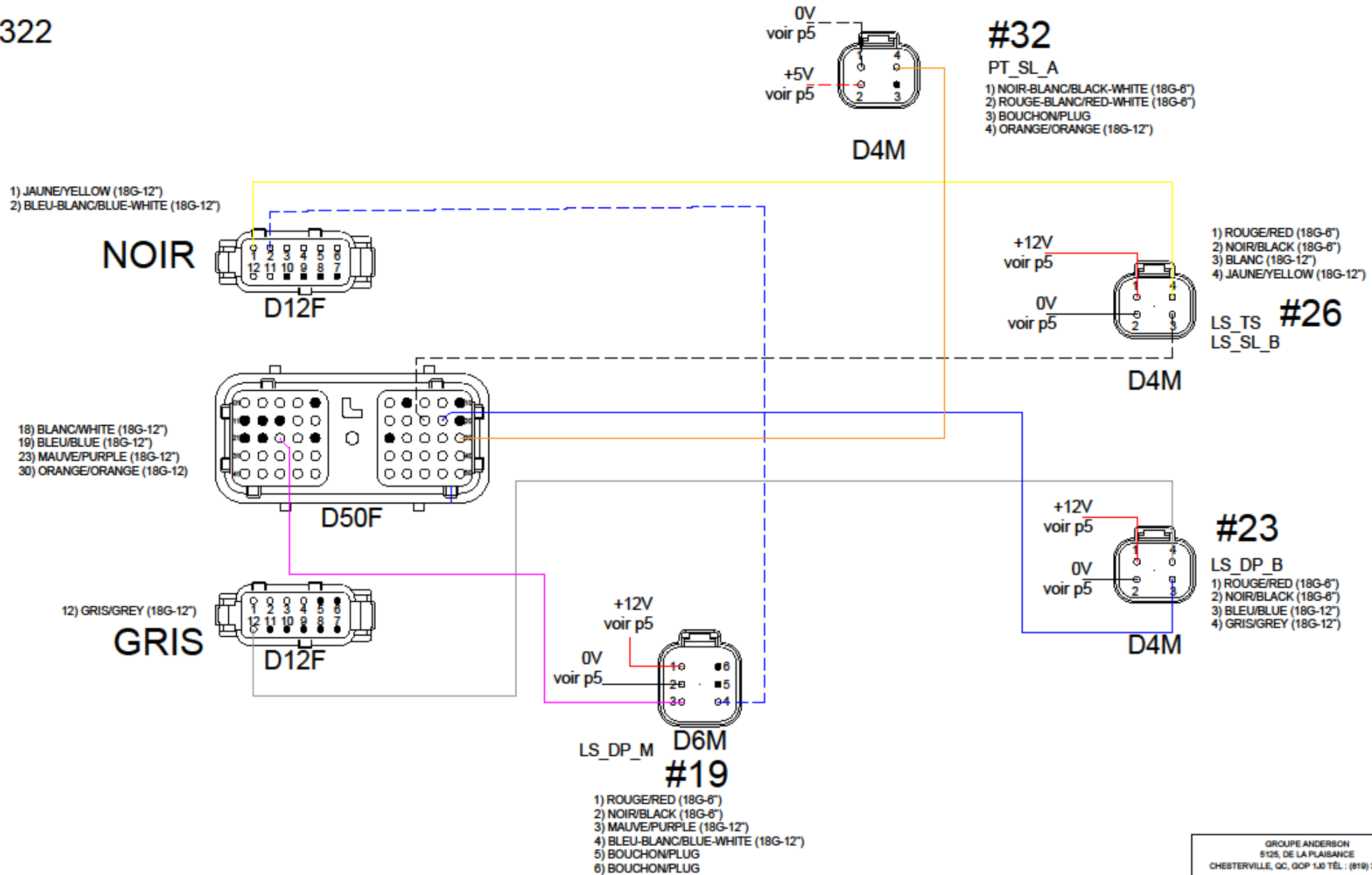

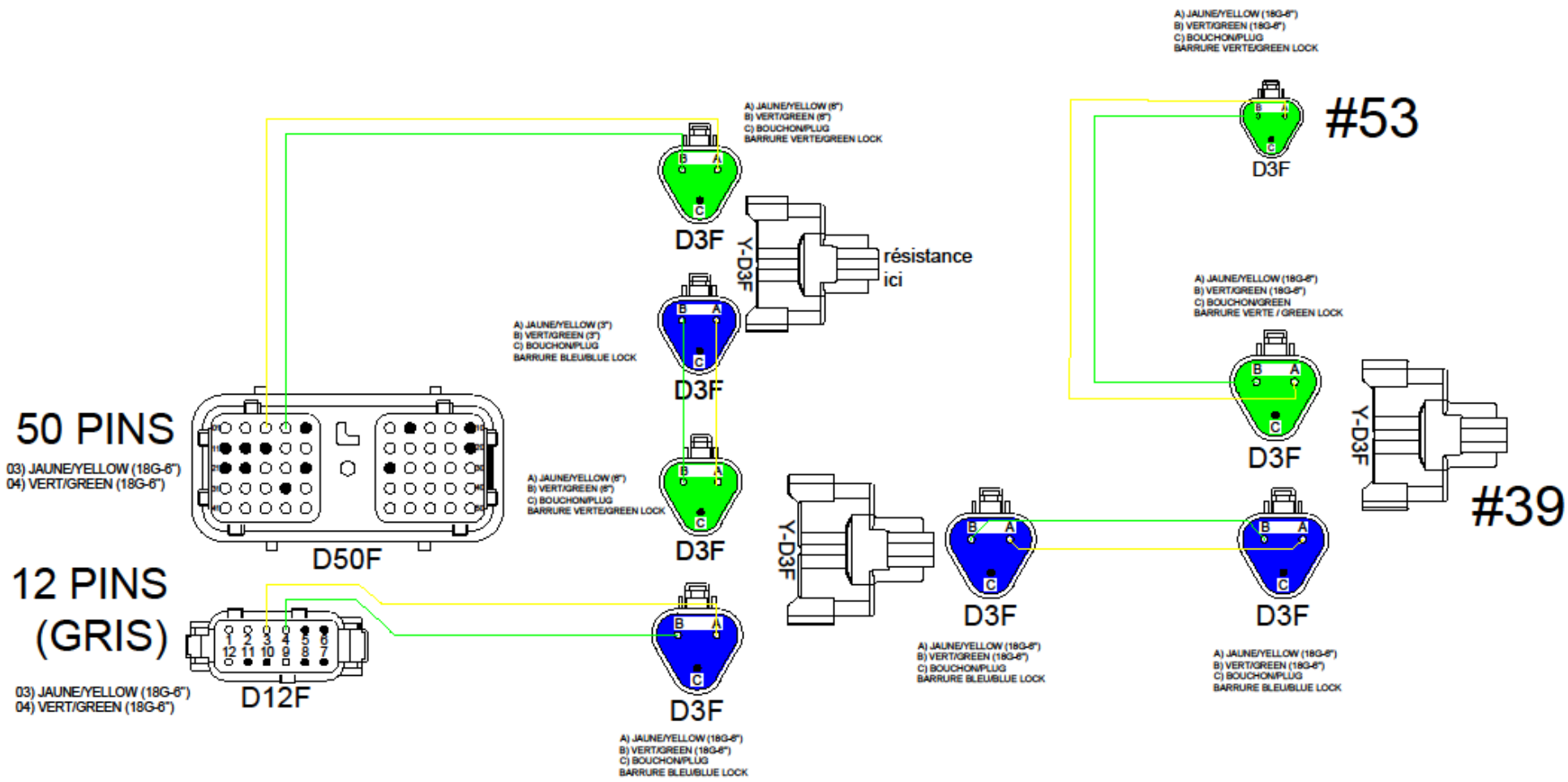

315322



- 1) NOIR/BLACK (18G-4')
- 2) ROUGE/RED (18G-4')
- 3) ROUGE-BLANC/RED-WHITE (18G-4')
- 4) NOIR-BLANC/BLACK-WHITE (18G-4')
- 47) ROUGE/RED (18G-4')
- 48) ROUGE/RED (18G-4')
- 49) ROUGE/RED (18G-4')
- 50) ROUGE/RED (18G-4')

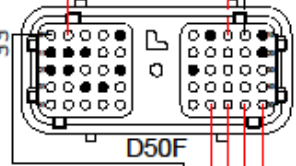

- 5) NOIR/BLACK (18G-4')
- 1) NOIR-BLANC/BLACK-WHITE (18G-4')
- 2) ROUGE-BLANC/RED-WHITE (18G-4')
- 1) NOIR-BLANC/BLACK-WHITE (18G-4')
- 2) ROUGE-BLANC/RED-WHITE (18G-4')
- 1) NOIR-BLANC/BLACK-WHITE (18G-4')
- 2) ROUGE-BLANC/RED-WHITE (18G-4')
- 1) NOIR-BLANC/BLACK-WHITE (18G-4')
- 4) ROUGE/RED (18G-4')

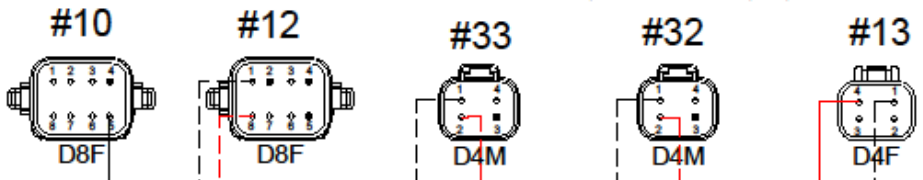

NOIR

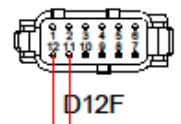

- 11) ROUGE/RED (18G-4')
- 12) ROUGE/RED (18G-4')

ROUGE 3"

GRIS

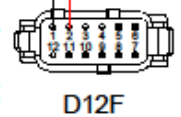

- 1) NOIR/BLACK (18G-4')
- 2) ROUGE/RED (18G-4')

NOIR 3"



#29  
1) ROUGE/RED (18G-4')  
2) NOIR/BLACK (18G-4')  
12V



#23  
1) ROUGE/RED (18G-4')  
2) NOIR/BLACK (18G-4')  
LS\_DP\_B

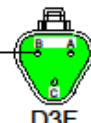

#16  
B) NOIR/BLACK (18G-4')  
BARRURE VERTE/GREEN LOCK  
VALVE SÉQ



#26  
1) ROUGE/RED (18G-4')  
2) NOIR/BLACK (18G-4')  
LS\_TS  
LS\_SL\_B



#19  
1) ROUGE/RED (18G-4')  
2) NOIR/BLACK (18G-4')  
PLAT

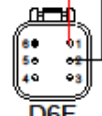

#38  
1) ROUGE/RED (18G-4')  
2) NOIR/BLACK (18G-4')  
BRAS

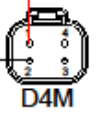

#35  
1) ROUGE/RED (18G-4')  
2) NOIR/BLACK (18G-4')  
LS\_BA\_SL  
LS\_PO\_R

GROUPE ANDERSON 5125, DE LA PLAISANCE CHESTERVILLE, QC, G0P 1J0 TEL : (819) 382-2952 No PIÉCE : 315322 DERNIER ENREGISTREMENT : 29-oct-20 FICHER : 310322P5.DWG
--

315323

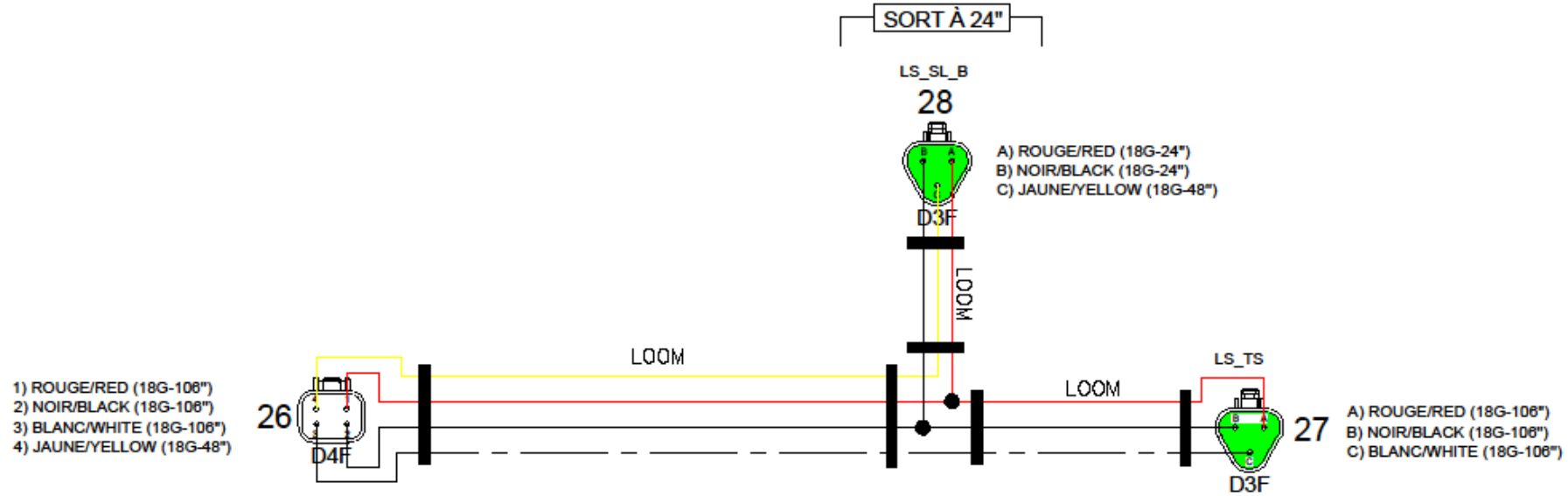

GRUPE ANDERSON 5125, DE LA PLAISANCE CHESTERVILLE, QC, G0P 1J0 TEL : (514) 382-2952
No PIÈCE :
DERNIER ENREGISTREMENT : 31-mars-21
FICHER : 31 0323.DWG

315324

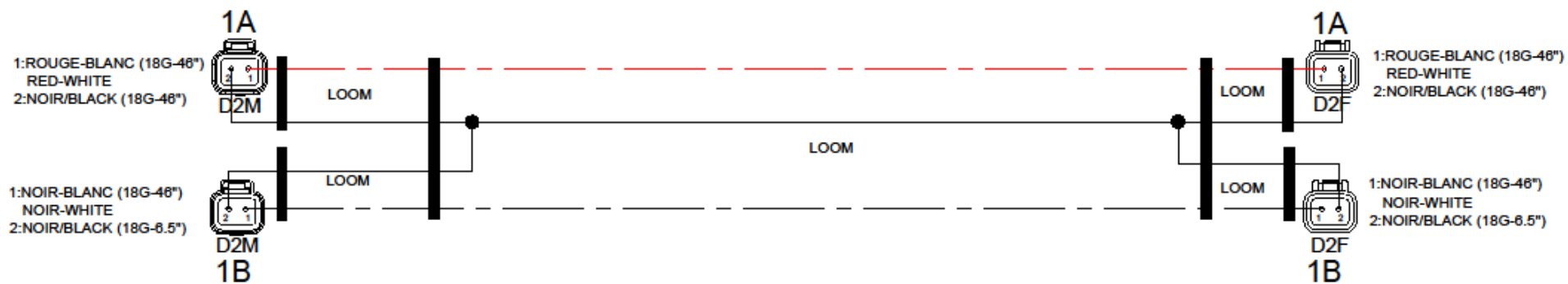

GRUPE ANDERSON 5125, DE LA PLAISANCE CHESTERVILLE, QC, G0P 1J0 TEL : (514) 382-2952
No PIÈCE :
DERNIER ENREGISTREMENT : 31-mars-21
FICHER : 31 0324.DWG



315325

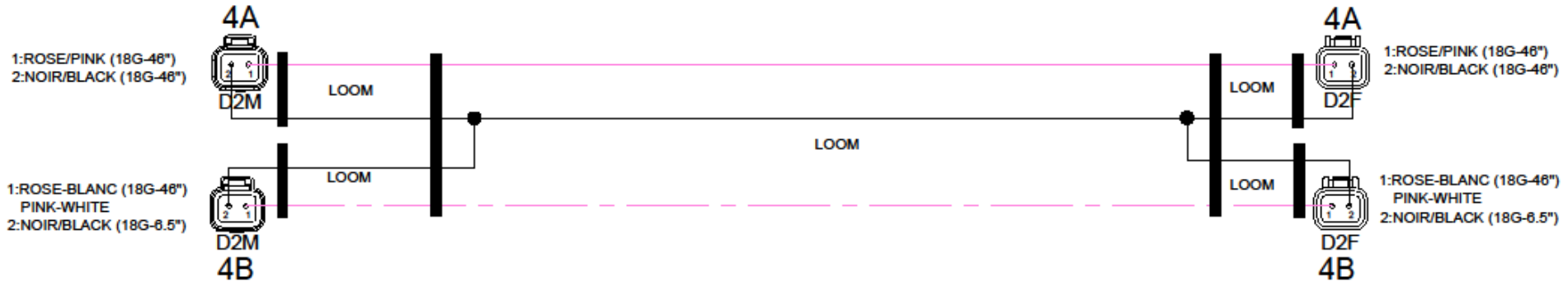

315326

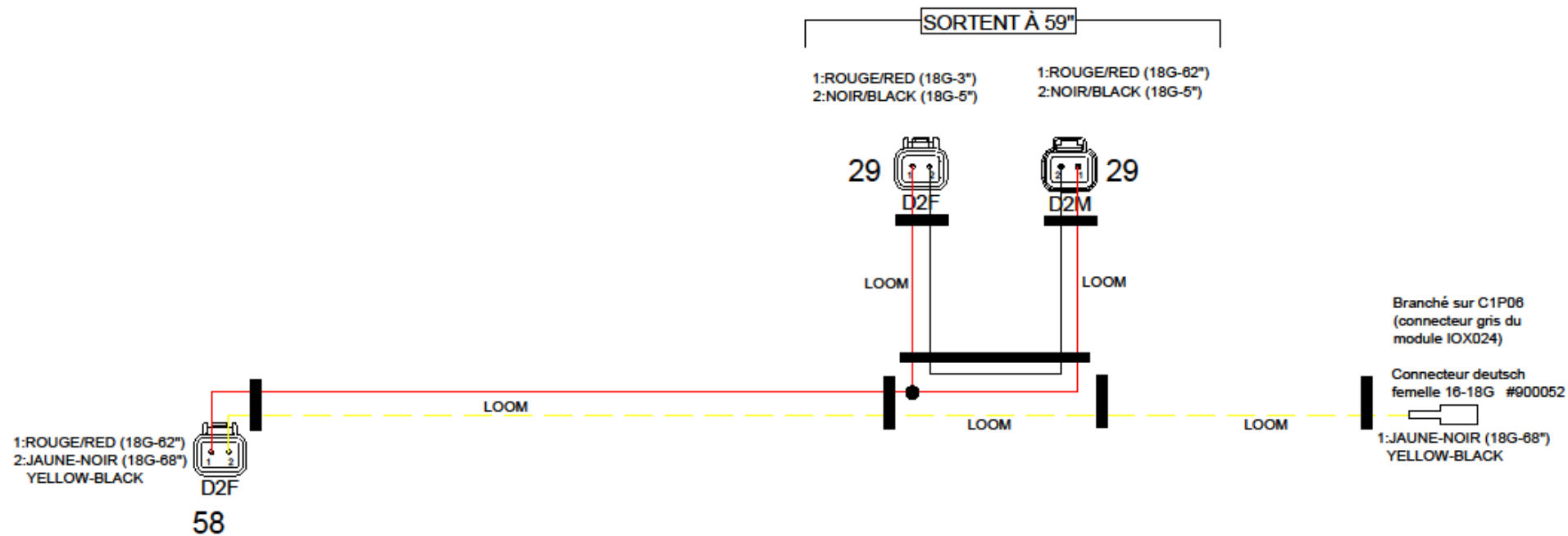

GRUPE ANDERSON 5125, DE LA PLAISANCE CHESTERVILLE, QC, GOP 1J0 TÉL : (514) 382-2052
No PIÈCE :
DERNIER ENREGISTREMENT : 31-mars-21
FICHER : 31 0328.DWG