



STACKPRO 7200

Electric Diagram / Diagramme Électrique

To navigate the electric diagram, you can click on the **red rectangle** that identify the wiring section you want to look up, click on the



button to go back to the main section.

Pour naviguer dans le schéma électrique, vous pouvez cliquer sur les **rectangles rouges** qui identifie la section du câblage que vous souhaitez regarder, cliquez sur le bouton



pour revenir à la section principale.

DIAGRAMME ÉLECTRIQUE/ELECTRIC DIAGRAM – STACKPRO 7200 V2.0

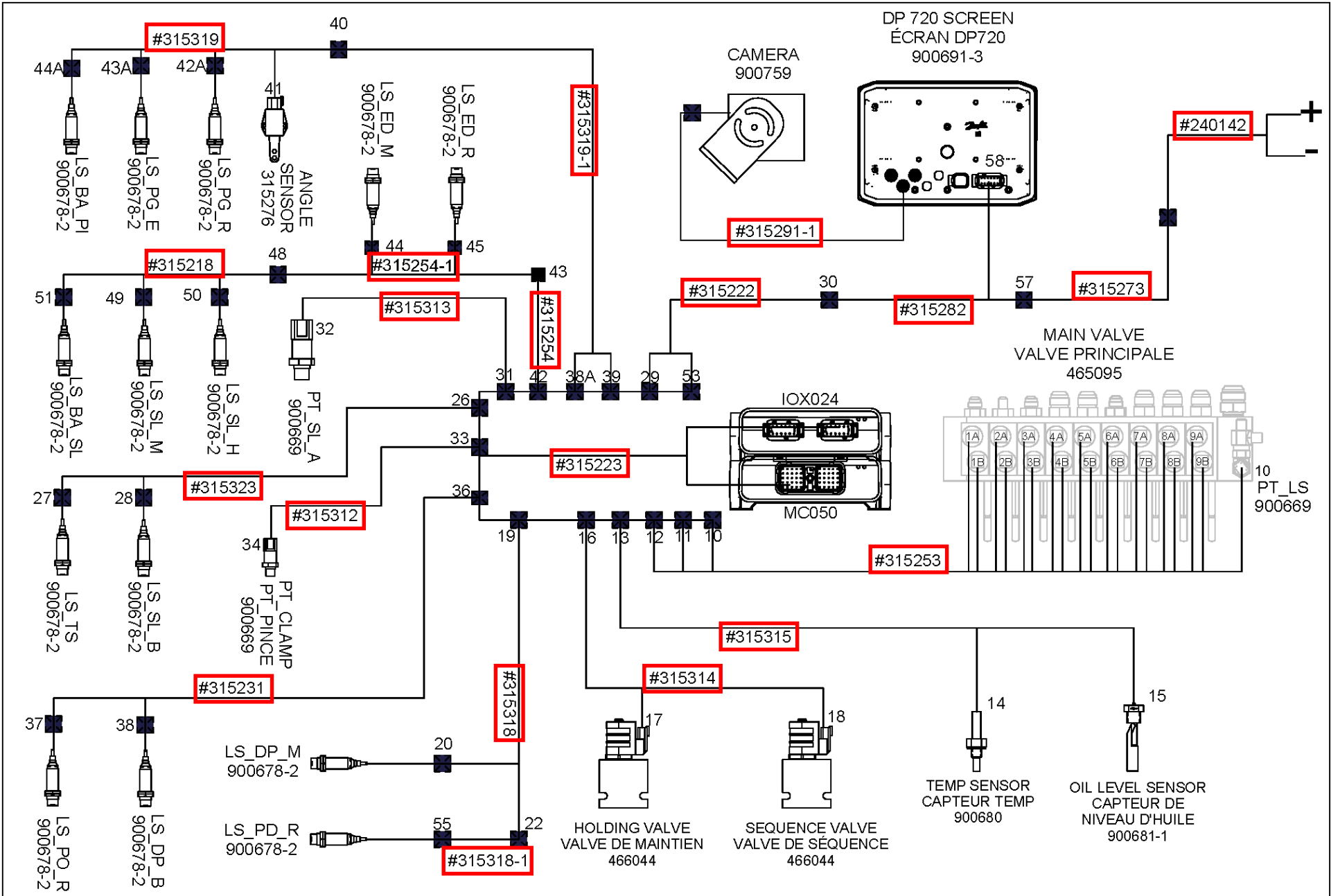

240142

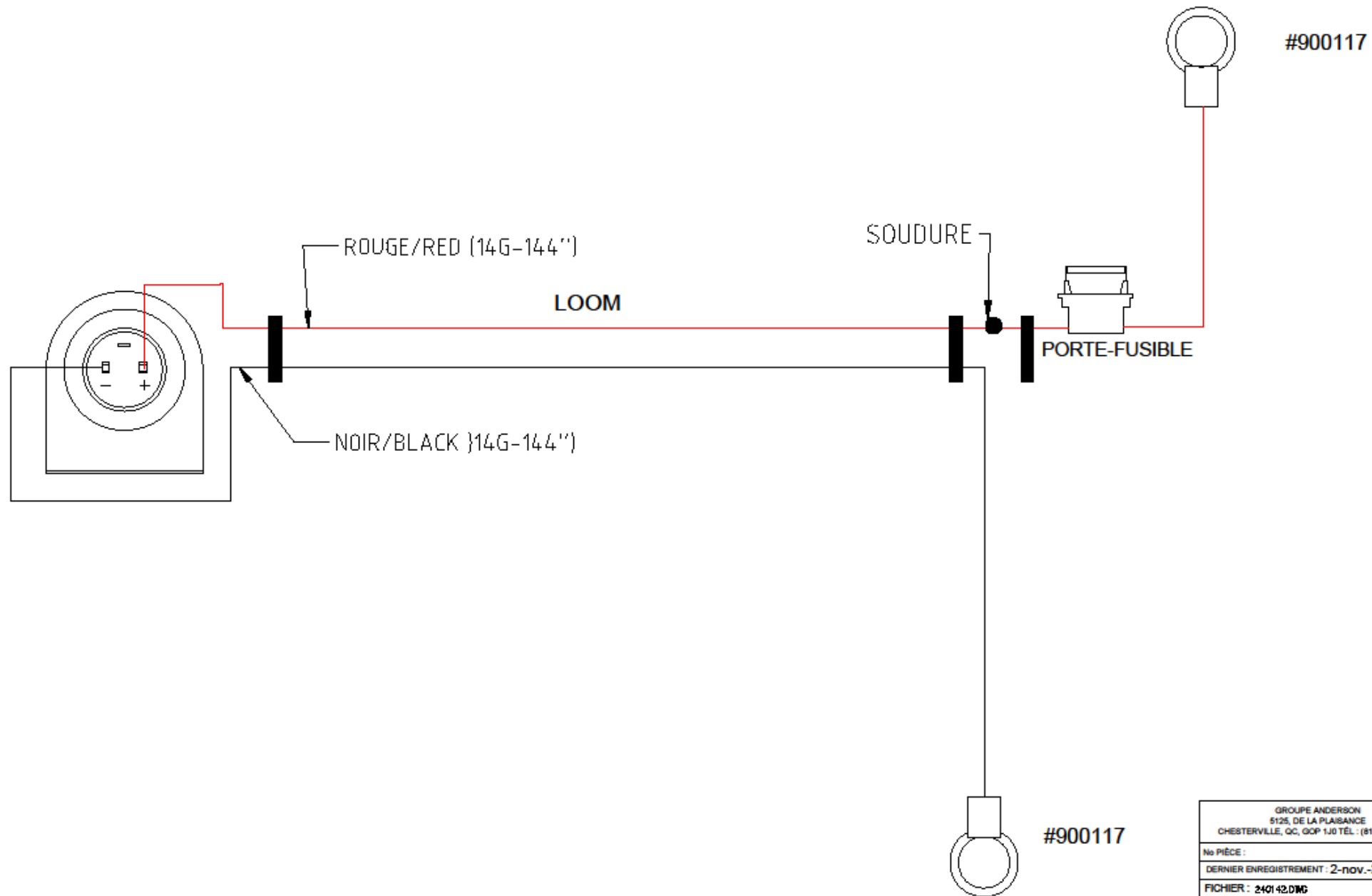

GRUPE ANDERSON 5125, DE LA PLAISANCE CHESTERVILLE, QC, G0P 1J0 TEL : (514) 382-2052
No PIÈCE :
DERNIER ENREGISTREMENT : 2-nov.-20
FICHER : 240142.DWG

315222

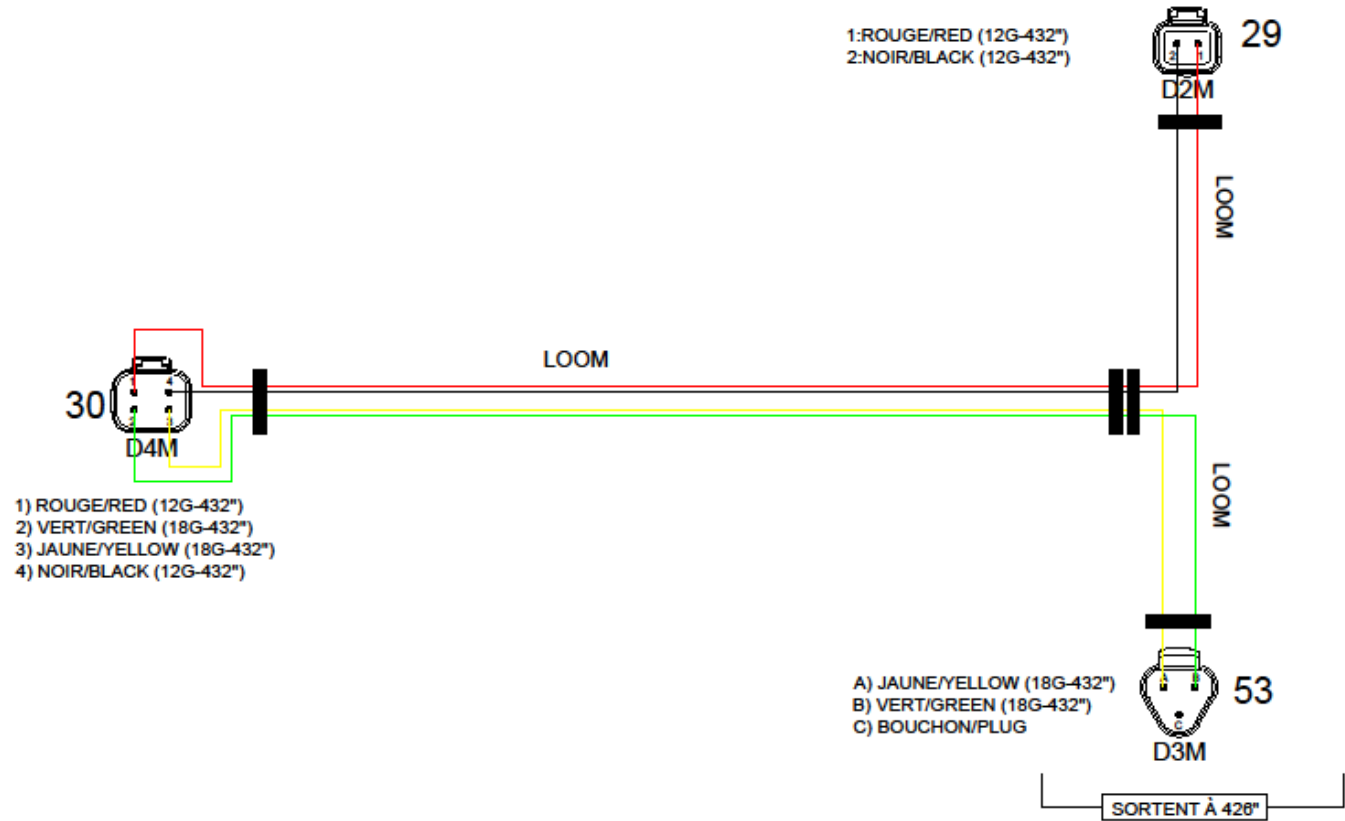

GRUPE ANDERSON 5125, DE LA PLAISANCE CHESTERVILLE, QC, G0P 1J0 TEL : (514) 382-2952
No PIÈCE :
DERNIER ENREGISTREMENT : 1-déc.-20
FICHER :

315223



- 29) JAUNE-NOIR (18G-12")
YELLOW-BLACK
- 35) BLANC/WHITE (18G-12")
- 36) BLANC-NOIR (18G-12")
WHITE-BLACK
- 37) GRIS/GREY (18G-12")
- 38) GRIS-BLANC (18G-12")
GREY-WHITE
- 39) MAUVE/PURPLE (18G-12")
- 40) MAUVE-BLANC (18G-12")
PURPLE-WHITE
- 41) BLEU/BLEU (18G-12")
- 42) BLEU-BLANC (18G-12")
BLUE-WHITE
- 43) ROSE-PINK (18G-12")
- 44) ROSE-BLANC (18G-12")
PINK-WHITE
- 45) JAUNE/YELLOW (18G-12")
- 46) JAUNE-BLANC (18G-12")
YELLOW-WHITE

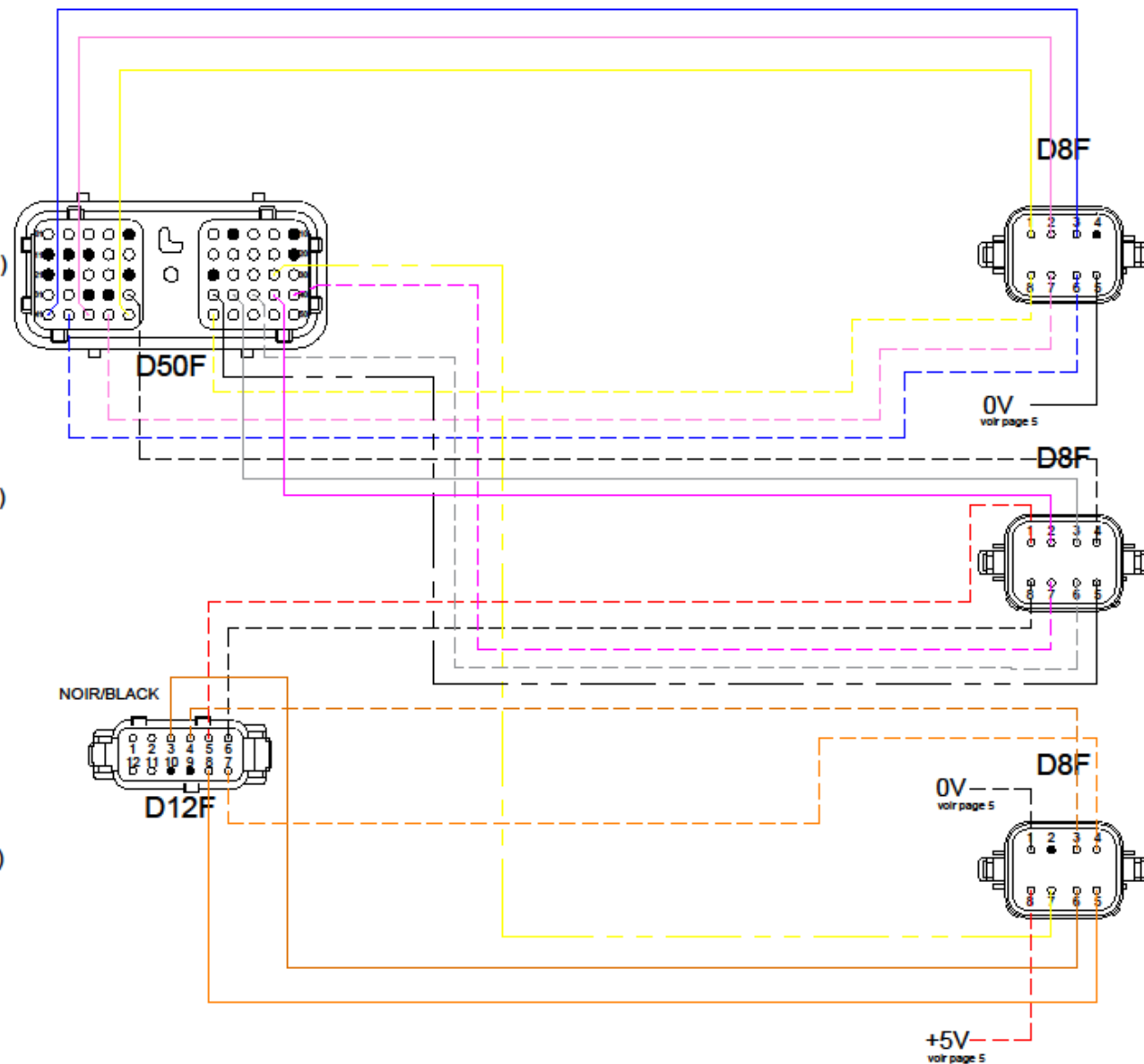

- 3) BRUN/BROWN (18G-12")
- 4) BRUN-BLANC (18G-12")
BROWN-WHITE
- 5) ROUGE-BLANC (18G-12")
RED-WHITE
- 6) NOIR-BLANC (18G-12")
BLACK-WHITE
- 7) ORANGE-BLANC(18G-12")
ORANGE-WHITE
- 8) ORANGE (18G-12")

- 1) JAUNE (12")
- 2) ROSE (12")
- 3) BLEU (12")
- 4) BOUCHON
- 5) NOIR (4")
- 6) BLEU-BLANC (12")
- 7) ROSE-BLANC (12")
- 8) JAUNE-BLANC (12")

#10

- 1) ROUGE-BLANC (12")
- 2) MAUVE (12")
- 3) GRIS (12")
- 4) BLANC (12")
- 5) BLANC-NOIR (12")
- 6) GRIS-BLANC (12")
- 7) MAUVE-BLANC (12")
- 8) NOIR-BLANC (12")

#11

- 1) NOIR-BLANC (6")
- 2) BOUCHON
- 3) BRUN-BLANC (12")
- 4) ORANGE-BLANC(12")
- 5) ORANGE (12")
- 6) BRUN (12")
- 7) JAUNE-NOIR (12")
- 8) ROUGE-BLANC (6")

#12

GROUPE ANDERSON 5125, DE LA PLAISANCE CHESTERVILLE, QC, G0P 1J0 TÉL. : (514) 382-2952	
No PIÈCE :	
DERNIER ENREGISTREMENT : 1-déc.-20	
FICHER : 315223.DWG	

315223



- | | | |
|--|---|---|
| <p>MAINTIEN SEQUENCE</p> <p>A) JAUNE-BLANC/ (18G-12")
YELLOW-WHITE</p> <p>B) NOIR/BLACK (18G-6")</p> <p>C) VERT/GREEN (18G-12")</p> | <p>TEMP</p> <p>1) NOIR-BLANC/ (18G-6")
BLACK-WHITE</p> <p>2) ORANGE-BLANC (18G-12")
ORANGE-WHITE</p> <p>3) VERT/GREEN (18G-12")</p> <p>4) ROUGE/RED (18G-6")</p> | <p>PT-PINCE</p> <p>1) NOIR-BLANC/BLACK-WHITE (18G-12")</p> <p>2) ROUGE-BLANC/RED-WHITE (18G-12")</p> <p>3) BOUCHON/PLUG</p> <p>4) BRUN/BROWN (18G-12")</p> |
|--|---|---|

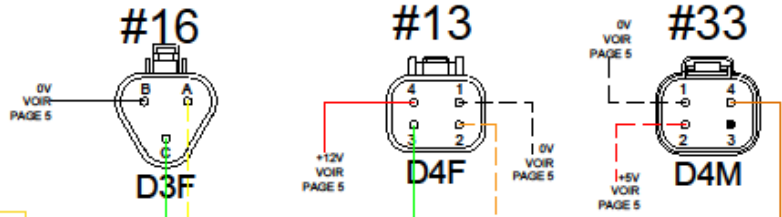

- 06) VERT/GREEN (18G-12")
- 14) MAUVE/PURPLE (18G-12")
- 15) ROSE/PINK (18G-12")
- 16) JAUNE-NOIR/(18G-12")
YELLOW-BLACK
- 19) GRIS/GREY (18G-12")
- 24) BLEU/BLUE (18G-12")
- 27) ORANGE-BLANC/(18G-12")
ORANGE-WHITE
- 28) BRUN/BROWN (18G-12")
- 30) ORANGE/ORANGE (18G-12")
- 31) VERT/GREEN (18G-12")
- 32) JAUNE-BLANC/ (18G-12")
YELLOW-WHITE

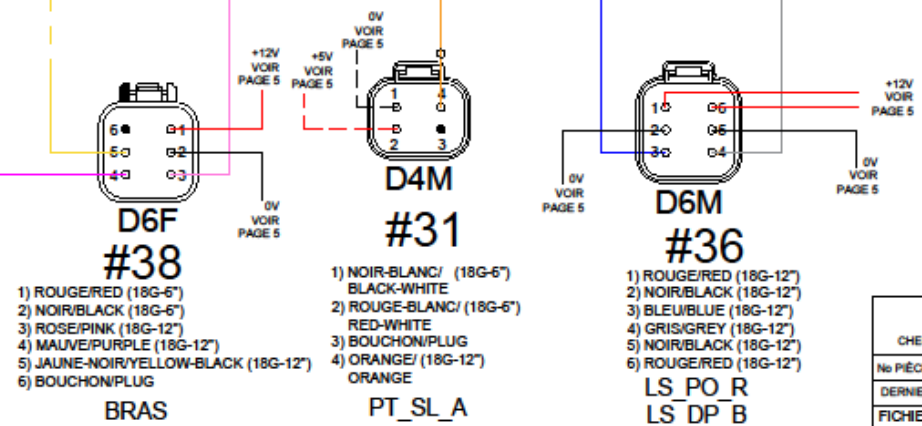
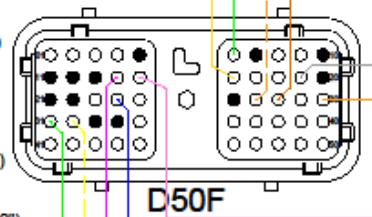

- | | | |
|---|--|---|
| <p>#38</p> <p>1) ROUGE/RED (18G-6")</p> <p>2) NOIR/BLACK (18G-6")</p> <p>3) ROSE/PINK (18G-12")</p> <p>4) MAUVE/PURPLE (18G-12")</p> <p>5) JAUNE-NOIR/YELLOW-BLACK (18G-12")</p> <p>6) BOUCHON/PLUG</p> <p>BRAS</p> | <p>#31</p> <p>1) NOIR-BLANC/ (18G-6")
BLACK-WHITE</p> <p>2) ROUGE-BLANC/ (18G-6")
RED-WHITE</p> <p>3) BOUCHON/PLUG</p> <p>4) ORANGE/ (18G-12")
ORANGE</p> <p>PT_SL_A</p> | <p>#36</p> <p>1) ROUGE/RED (18G-12")</p> <p>2) NOIR/BLACK (18G-12")</p> <p>3) BLEU/BLUE (18G-12")</p> <p>4) GRIS/GREY (18G-12")</p> <p>5) NOIR/BLACK (18G-12")</p> <p>6) ROUGE/RED (18G-12")</p> <p>LS_PO_R</p> <p>LS_DP_B</p> |
|---|--|---|

<p>GRUPE ANDERSON 5125, DE LA PLAISANCE CHESTERTVILLE, QC, GOP 1J0 TEL : (819) 382-2952</p>
<p>No PIÈCE :</p>
<p>DERNIER ENREGISTREMENT : 1-déc.-20</p>
<p>FICHER : 315223.DWG</p>

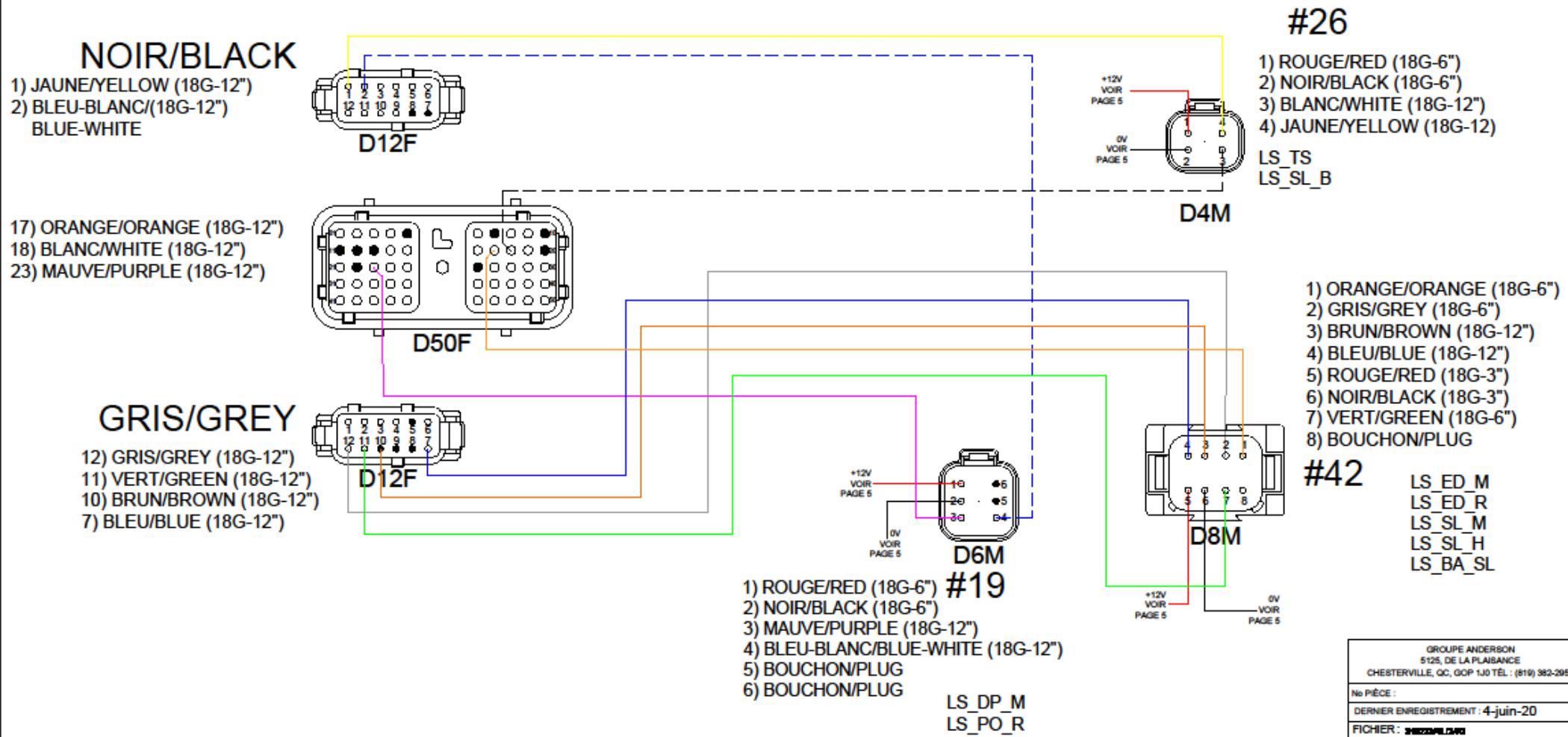

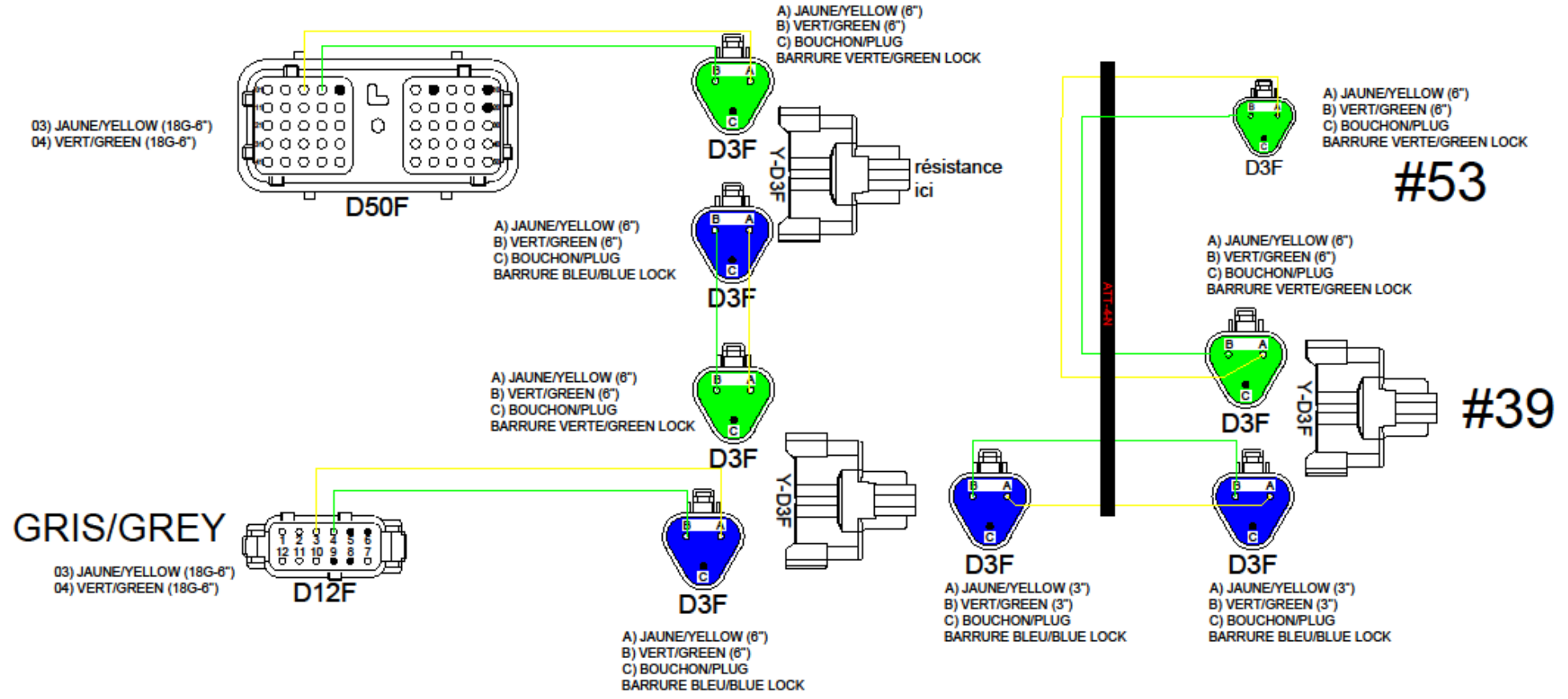

315231



- 1:ROUGE/RED (18G-28")
- 2:NOIR/BLACK (18G-28")
- 3:BLEU/BLEUE (18G-28")
- 4:GRIS/GREY (18G-28")
- 5:NOIR/BLACK (18G-28")
- 6:ROUGE/RED (18G-28")

#36

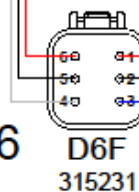

D6F
315231

LOOM

LOOM

CAP PROX
POUSOIR
RETRACT

#37

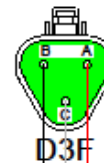

- A:ROUGE/RED (18G-28")
- B:NOIR/BLACK (18G-28")
- C:GRIS/GREY (18G-28")

D3F

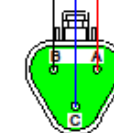

- A:ROUGE/RED (18G-28")
- B:NOIR/BLACK (18G-28")
- C:BLEU/BLEUE (18G-28")

D3F

#38

CAP PROX
DOMPEUR BAS

GRUPE ANDERSON 5125, DE LA PLAISANCE CHESTERVILLE, QC, G0P 1J0 TEL : (514) 382-2952
No PIÈCE :
DERNIER ENREGISTREMENT : 21-sept-22
FICHER : 078-215231.DWG

315253

- 1A** 1) ROUGE-BLANC (18G-26")
RED-WHITE
2) NOIR/BLACK (18G-6 1/2")
- 1B** 1) NOIR-BLANC (18G-26")
BLACK-WHITE
2) NOIR/BLACK (18G-6 1/2")

SORTENT À 20"

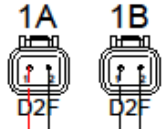

LOOM(16 X)

- 3A** 1) JAUNE/YELLOW (18G-30")
2) NOIR/BLACK (18G-6 1/2")
- 3B** 1) JAUNE-BLANC (18G-30")
YELLOW-WHITE
2) NOIR/BLACK (18G-6 1/2")

SORTENT À 24"

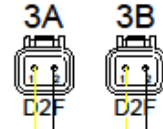

- 5A** 1) ORANGE (18G-34")
2) NOIR/BLACK (18G-6 1/2")
- 5B** 1) ORANGE-BLANC (18G-34")
ORANGE-WHITE
2) NOIR/BLACK (18G-6 1/2")

SORTENT À 28"

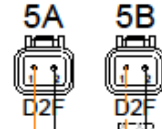

- 6A** 1) BLEU/BLUE (18G-36")
2) NOIR/BLACK (18G-6 1/2")
- 6B** 1) BLEU-BLANC (18G-36")
BLUE-WHITE
2) NOIR/BLACK (18G-6 1/2")

SORTENT À 30"

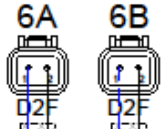

- 8A** 1) GRIS/GREY (18G-40")
2) NOIR/BLACK (18G-6 1/2")
- 8B** 1) GRIS-BLANC (18G-40")
GREY-WHITE
2) NOIR/BLACK (18G-6 1/2")

SORTENT À 34"

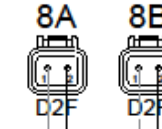

- 1) NOIR-BLANC (18G-46")
BLACK-WHITE
2) ROUGE-BLANC (18G-46")
RED-WHITE
3) BOUCHON/PLUG
4) JAUNE-NOIR (18G-46")
YELLOW-BLACK

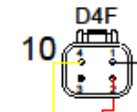

- 2A** 1) BRUN/BROWN (18G-28")
2) NOIR/BLACK (18G-6 1/2")
- 2B** 1) BRUN-BLANC (18G-28")
BROWN-WHITE
2) NOIR/BLACK (18G-6 1/2")

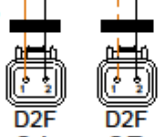

SORTENT À 22"

- 4A** 1) ROSE/PINK (18G-32")
2) NOIR/BLACK (18G-6 1/2")
- 4B** 1) ROSE-BLANC (18-32")
2) NOIR/BLACK (18G-6 1/2")

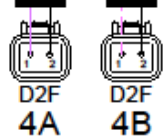

SORTENT À 26"

- 7A** 1) ROSE/PINK (18G-32")
2) NOIR/BLACK (18G-6 1/2")
- 7B** 1) ROSE-BLANC (18-32")
2) NOIR/BLACK (18G-6 1/2")

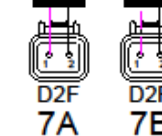

SORTENT À 32"

- 9A** 1) BLANC/WHITE (18G-42")
2) NOIR/BLACK (18G-42")
- 9B** 1) BLANC-NOIR (18G-42")
WHITE-BLACK
2) NOIR/BLACK (18G-42")

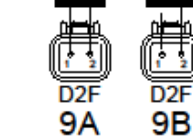

SORTENT À 36"

LOOM

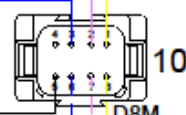

- 1) JAUNE/YELLOW (18G-30")
2) ROSE/PINK (18G-32")
3) BLEU/BLUE (18G-36")
4) BOUCHON/PLUG
5) NOIR/BLACK (18G-42")
6) BLEU-BLANC/BLUE-WHITE (18G-36")
7) ROSE-BLANC/PINK-WHITE (18G-32")
8) JAUNE-BLANC/YELLOW-WHITE (18G-30")

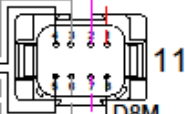

- 1) ROUGE-BLANC/RED-WHITE (18G-26")
2) MAUVE/PURPLE (18G-38")
3) GRIS/GREY (18G-40")
4) BLANC/WHITE (18G-42")
5) BLANC-NOIR/WHITE-BLACK (18G-42")
6) GRIS-BLANC/GREY-WHITE (18G-40")
7) MAUVE-BLANC/PURPLE-WHITE (18G-38")
8) NOIR-BLANC/BLACK-WHITE (18G-26")

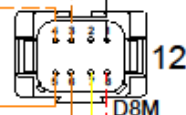

- 1) NOIR-BLANC/BLACK-WHITE (18G-46")
2) BOUCHON/PLUG
3) BRUN-BLANC/BROWN-WHITE (18G-28")
4) ORANGE-BLANC/ORANGE-WHITE (18G-34")
5) ORANGE (18G-34")
6) BRUN/BROWN (18G-28")
7) JAUNE-NOIR/YELLOW-BLACK (18G-46")
8) ROUGE-BLANC/RED-WHITE (18G-46")

GRUPE ANDERSON
5125, DE LA PLAISANCE
CHESTERTVILLE, QC, G0P 1J0 TEL : (819) 382-2952

No PIÈCE :

DERNIER ENREGISTREMENT : 21-sept-22

FICHER : 31 0253.DWG



315254

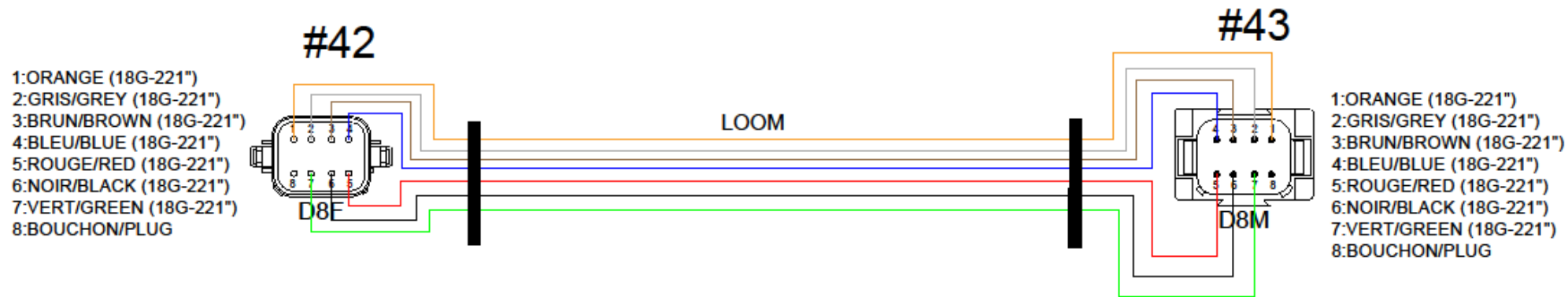

GRUPE ANDERSON 5125, DE LA PLAISANCE CHESTERVILLE, QC, G0P 1J0 TEL : (514) 382-2952
No PIÈCE :
DERNIER ENREGISTREMENT : 4-juin-20
FICHER : 315254.DWG

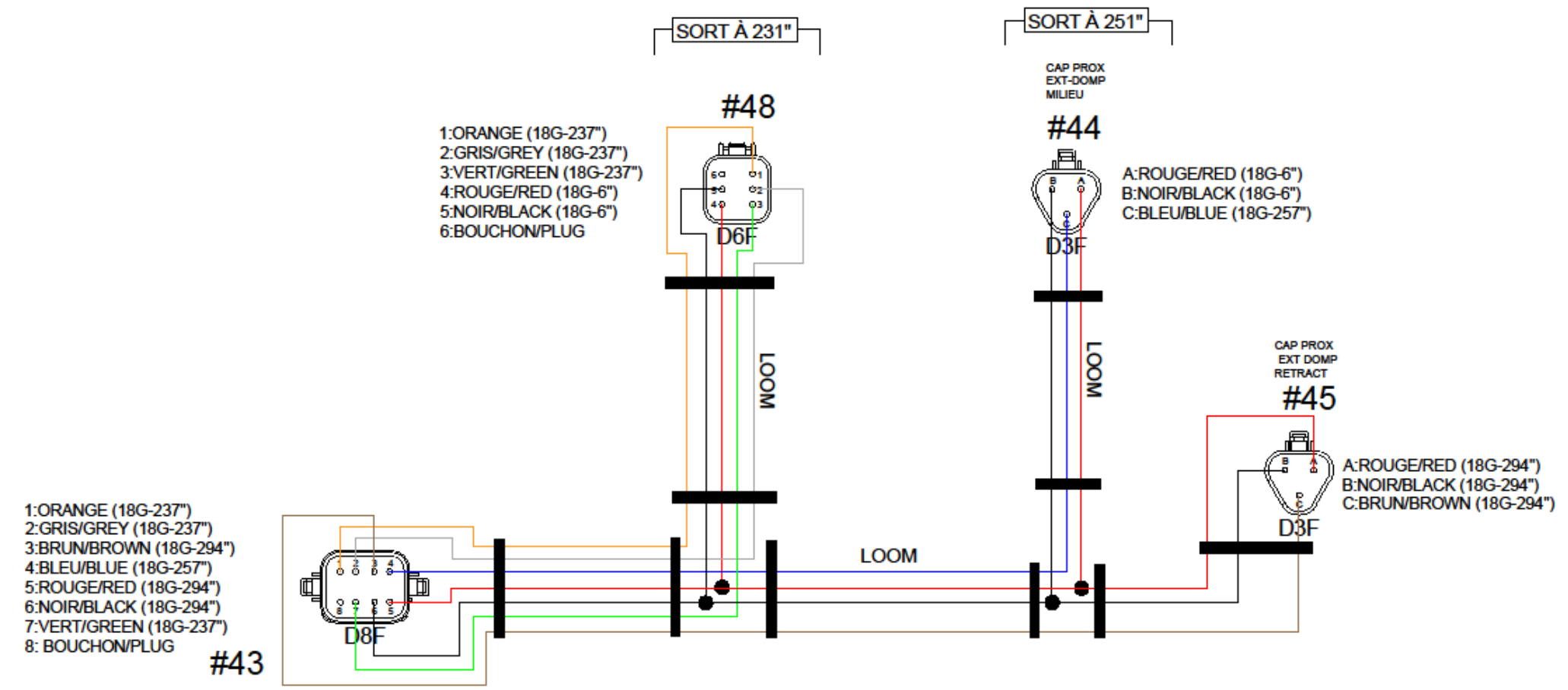

GROUPE ANDERSON 5125, DE LA PLAISANCE CHESTERVILLE, QC, G0P 1J0 TÉL : (514) 382-2052
No PIÈCE :
DERNIER ENREGISTREMENT : 1-déc.-20
FICHER : 315254-1.MWD

315273

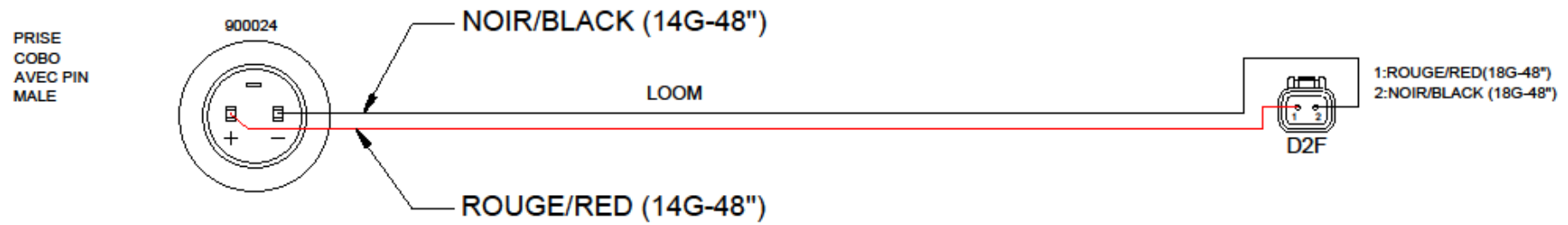

GRUPE ANDERSON 5125, DE LA PLAISANCE CHESTERVILLE, QC, G0P 1J0 TEL : (514) 382-2952
No PIÈCE :
DERNIER ENREGISTREMENT : 31-mars-21
FICHER : 31 0273 0102

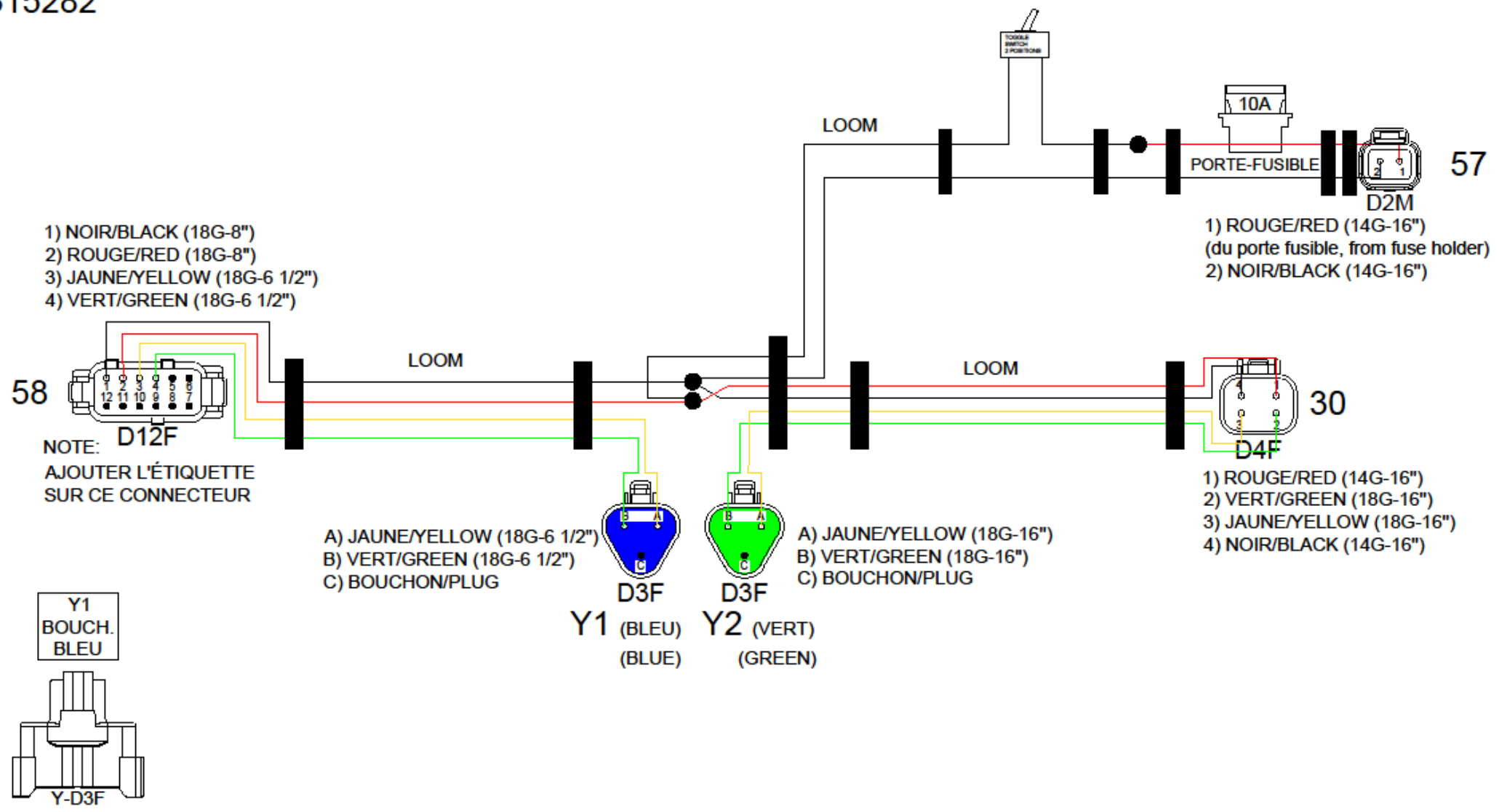

- 1) NOIR/BLACK (18G-8")
- 2) ROUGE/RED (18G-8")
- 3) JAUNE/YELLOW (18G-6 1/2")
- 4) VERT/GREEN (18G-6 1/2")

- 1) ROUGE/RED (14G-16")
(du porte fusible, from fuse holder)
- 2) NOIR/BLACK (14G-16")

NOTE:
AJOUTER L'ÉTIQUETTE
SUR CE CONNECTEUR

- A) JAUNE/YELLOW (18G-6 1/2")
- B) VERT/GREEN (18G-6 1/2")
- C) BOUCHON/PLUG

- A) JAUNE/YELLOW (18G-16")
- B) VERT/GREEN (18G-16")
- C) BOUCHON/PLUG

- 1) ROUGE/RED (14G-16")
- 2) VERT/GREEN (18G-16")
- 3) JAUNE/YELLOW (18G-16")
- 4) NOIR/BLACK (14G-16")

Y1
BOUCH.
BLEU

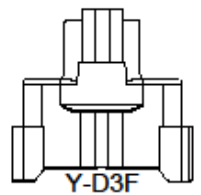

BOUCH.
RÉSIST. Y2
BOUCH.
VERT

Y1 (BLEU)
(BLUE) Y2 (VERT)
(GREEN)

GROUPE ANDERSON 5125, DE LA PLAISANCE CHESTERVILLE, QC, G0P 1J0 TÉL. : (819) 382-2052	
No PIÈCE :	
DERNIER ENREGISTREMENT : 21-sept.-22	
FICHER : 079-FL_315282.DWG	

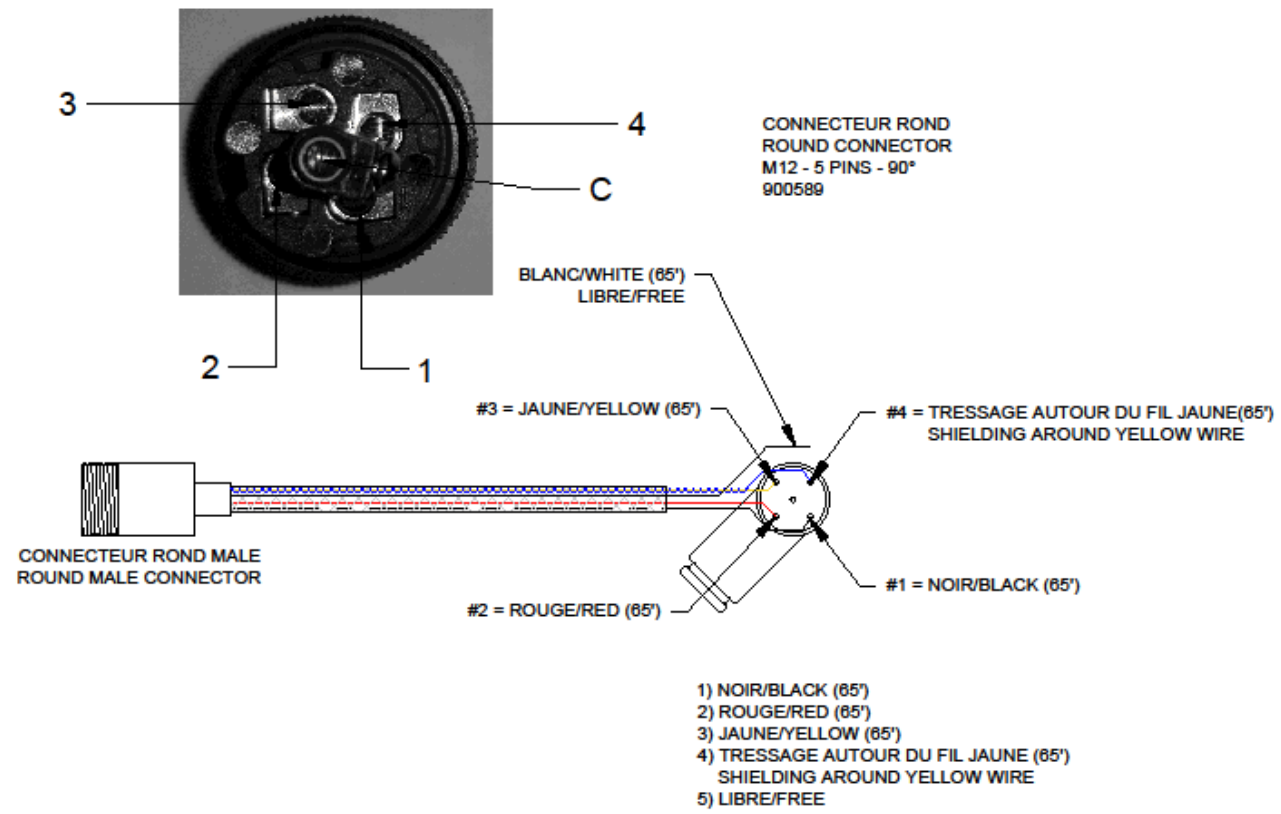

GROUPE ANDERSON 5125, DE LA PLAISANCE CHESTERVILLE, QC, G0P 1J0 TÉL. : (514) 382-2952
No PIÈCE :
DERNIER ENREGISTREMENT : 6-mai-20
FICHER : 679-FIL 242201-1-17962

- 1) NOIR-BLANC (18G-30")
BLACK-WHITE
- 2) ROUGE-BLANC (18G-30")
RED-WHITE
- 3) BOUCHON/PLUG
- 4) BRUN/BROWN (18G-30")

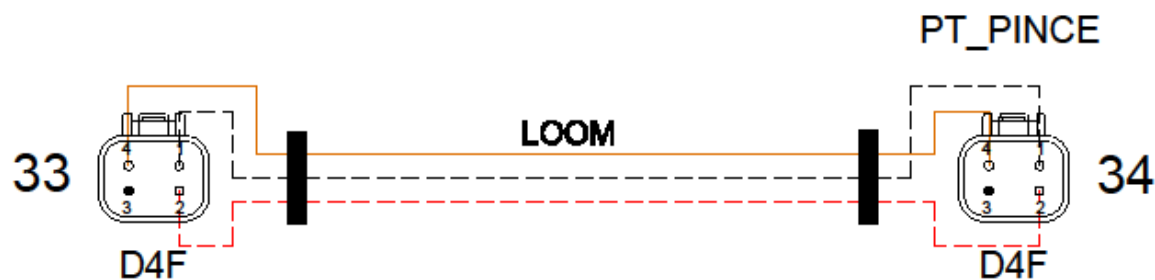

- 1) NOIR-BLANC (18G-30")
BLACK-WHITE
- 2) ROUGE-BLANC (18G-30")
RED-WHITE
- 3) BOUCHON/PLUG
- 4) BRUN/BROWN (18G-30")

315313



- 1) NOIR-BLANC (18G-46")
BLACK-WHITE
- 2) ROUGE-BLANC (18G-46")
RED-WHITE
- 3) BOUCHON/PLUG
- 4) ORANGE (18G-46")

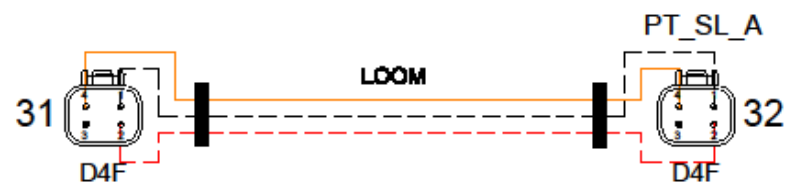

- 1) NOIR-BLANC (18G-46")
BLACK-WHITE
- 2) ROUGE-BLANC (18G-46")
RED-WHITE
- 3) BOUCHON/PLUG
- 4) ORANGE (18G-46")

GRUPE ANDERSON 5125, DE LA PLAISANCE CHESTERVILLE, QC, G0P 1J0 TEL : (514) 382-2052
No PIÈCE :
DERNIER ENREGISTREMENT : 11-mai-20
FICHER :

315314

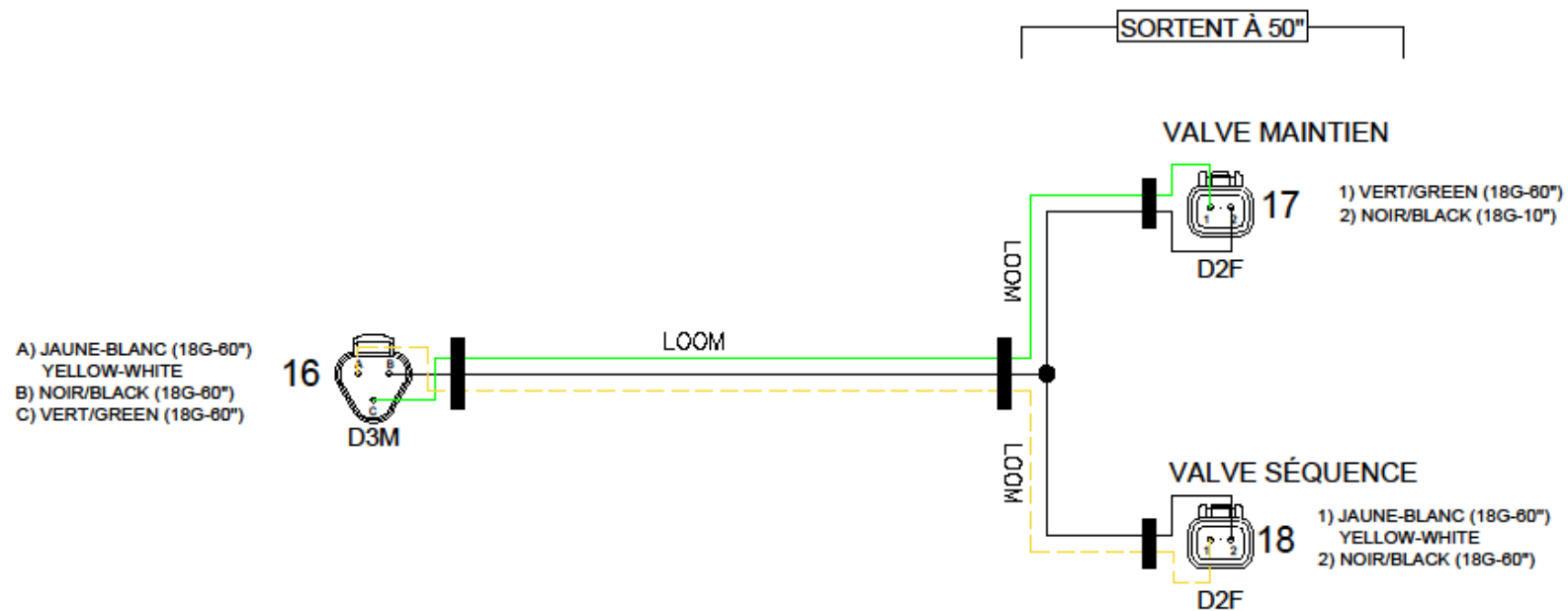

GRUPE ANDERSON 5125, DE LA PLAISANCE CHESTERVILLE, QC, G0P 1J0 TÉL. : (514) 382-2952
No PIÈCE :
DERNIER ENREGISTREMENT : 31-mars-21
FICHER : 31 0314.DWG

315315

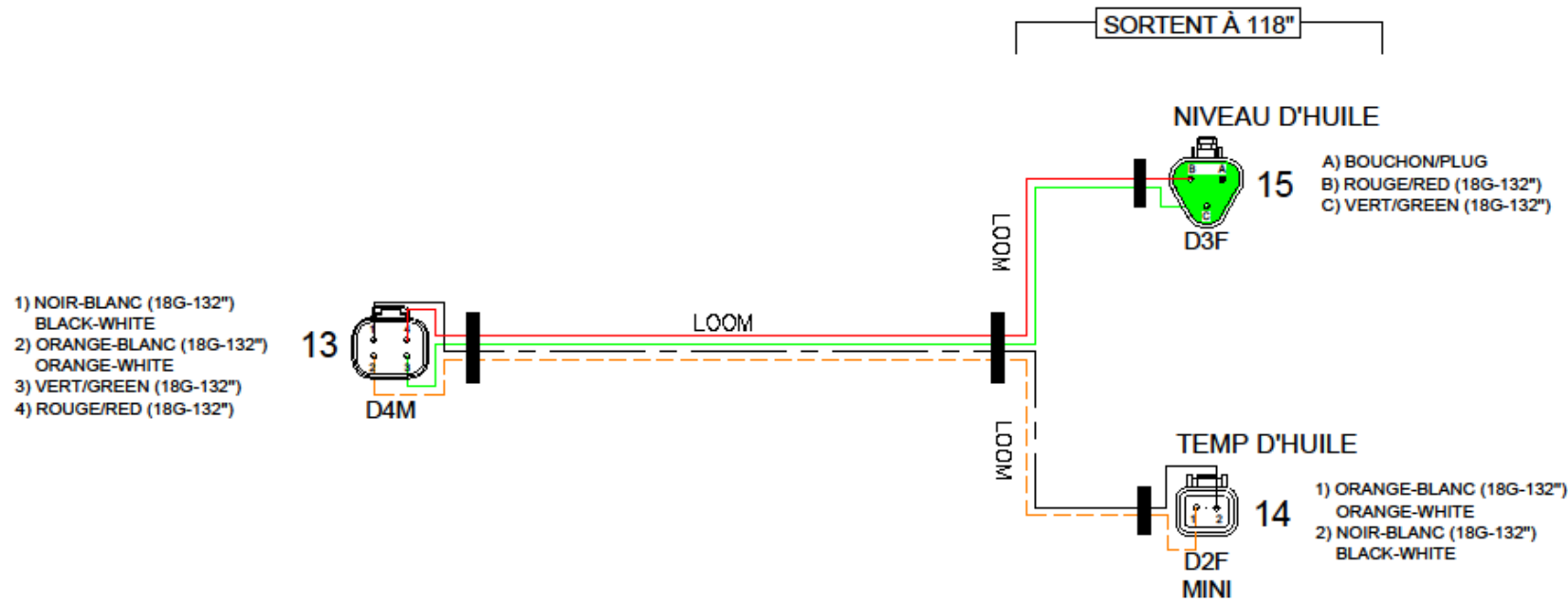

GRUPE ANDERSON 5125, DE LA PLAISANCE CHESTERVILLE, QC, G0P 1J0 TÉL. : (819) 382-2052
No PIÈCE :
DERNIER ENREGISTREMENT : 29-oct-20
FICHER : 310315.DWG

315318

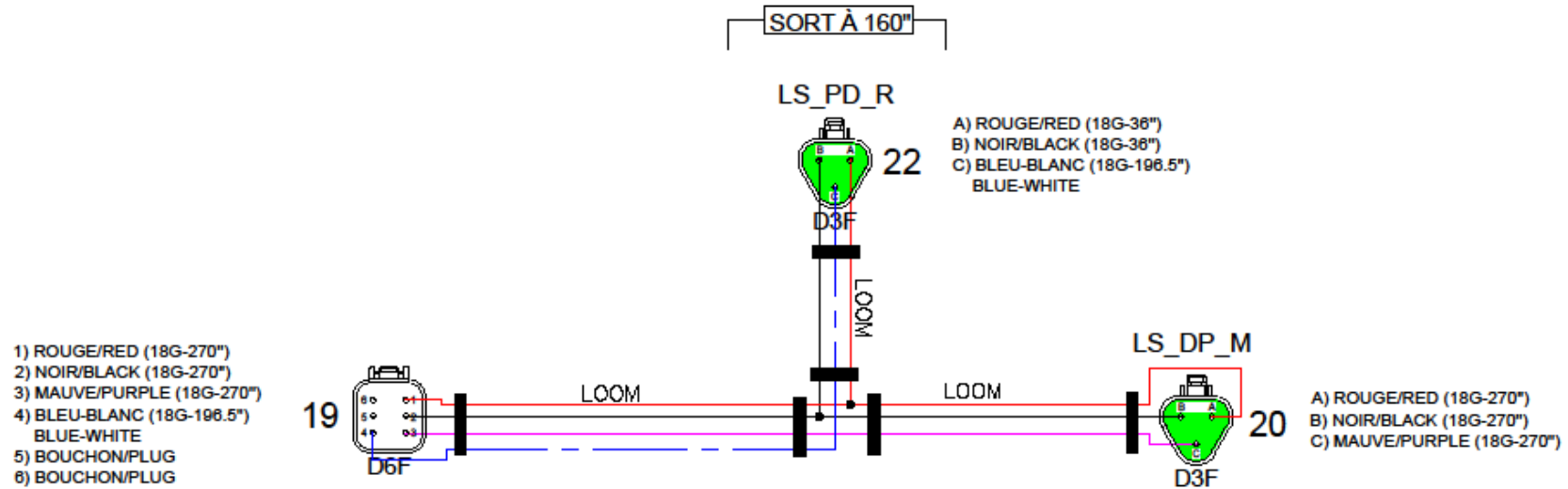

GRUPE ANDERSON 5125, DE LA PLAISANCE CHESTERVILLE, QC, GOP 1J0 TÉL. : (514) 382-2952
No Pièce :
DERNIER ENREGISTREMENT : 21-sept.-22
FICHER : 3103BLDWC

315318-1

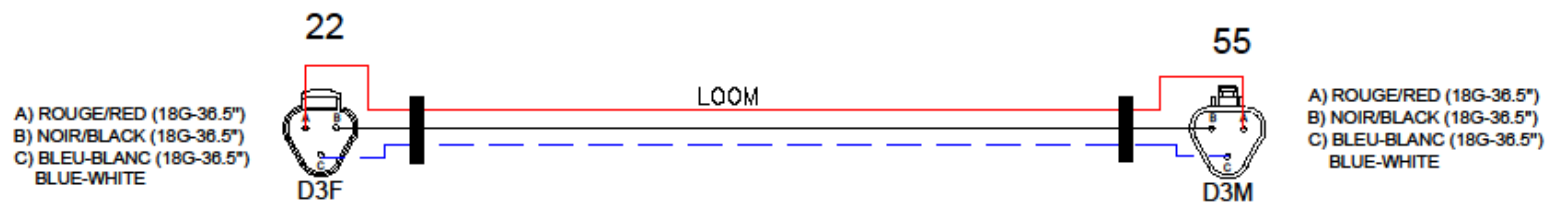

GROUPE ANDERSON 5125, DE LA PLAISANCE CHESTERVILLE, QC, G0P 1J0 TÉL : (819) 383-2952	
No PIÈCE :	
DERNIER ENREGISTREMENT :	21-sept-22
FICHER - 315318-1.DWG	

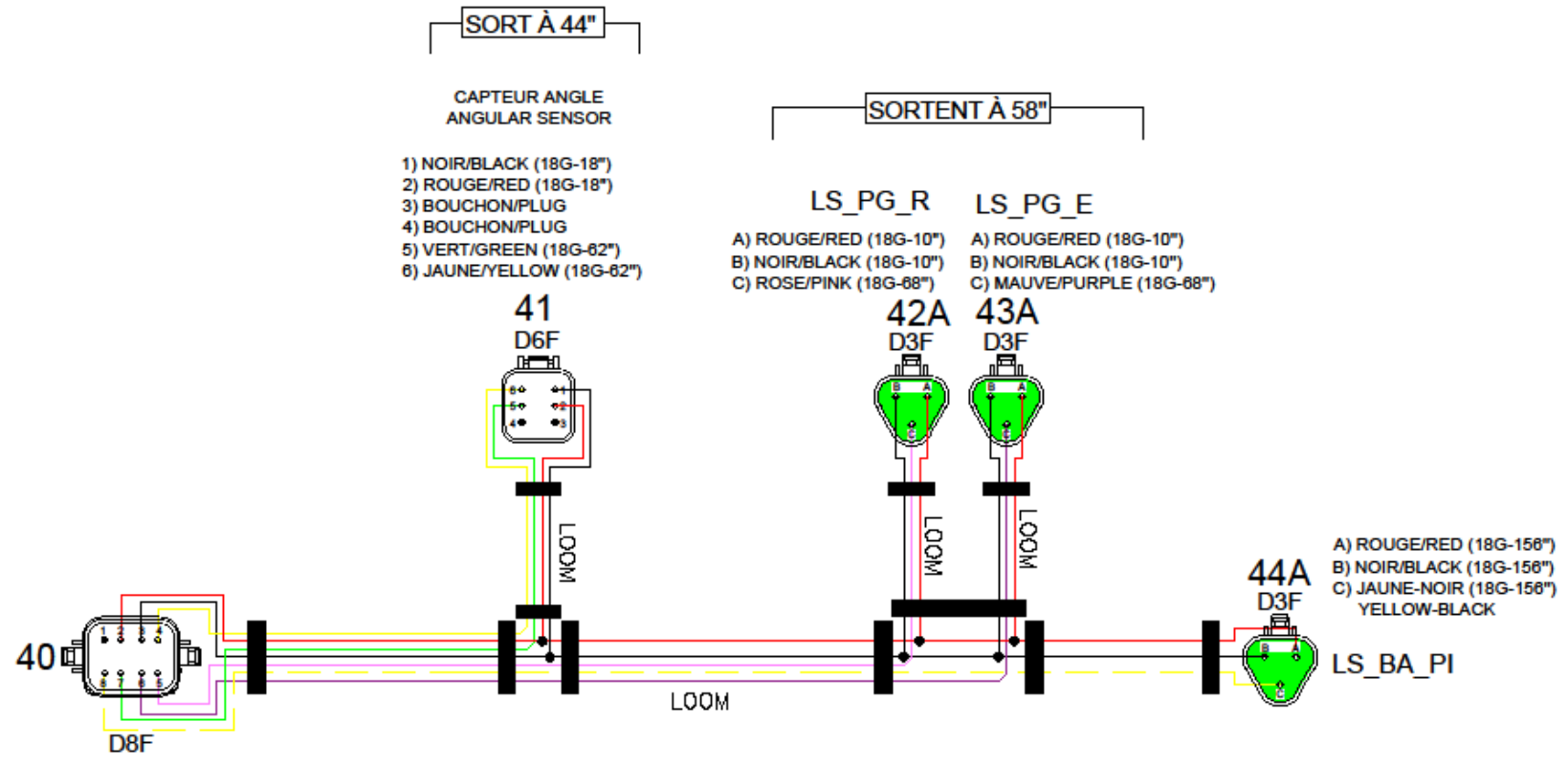

- 1) BOUCHON/PLUG
- 2) ROUGE/RED (18G-110")
- 3) NOIR/BLACK (18G-110")
- 4) JAUNE/YELLOW (18G-110")
- 5) ROSE/PINK (18G-110")
- 6) MAUVE/PURPLE (18G-110")
- 7) VERT/GREEN (18G-110")
- 8) JAUNE-NOIR (18G-110")
YELLOW-BLACK

