



# STACKPRO 7200

Electric Diagram / Diagramme Électrique

To navigate the electric diagram, you can click on the **red rectangle** that identify the wiring section you want to look up, click on the



button to go back to the main section.

Pour naviguer dans le schéma électrique, vous pouvez cliquer sur les **rectangles rouges** qui identifie la section du câblage que vous souhaitez regarder, cliquez sur le bouton



pour revenir à la section principale.

# DIAGRAMME ÉLECTRIQUE/ELECTRIC DIAGRAM – STACKPRO 7200 V2.0

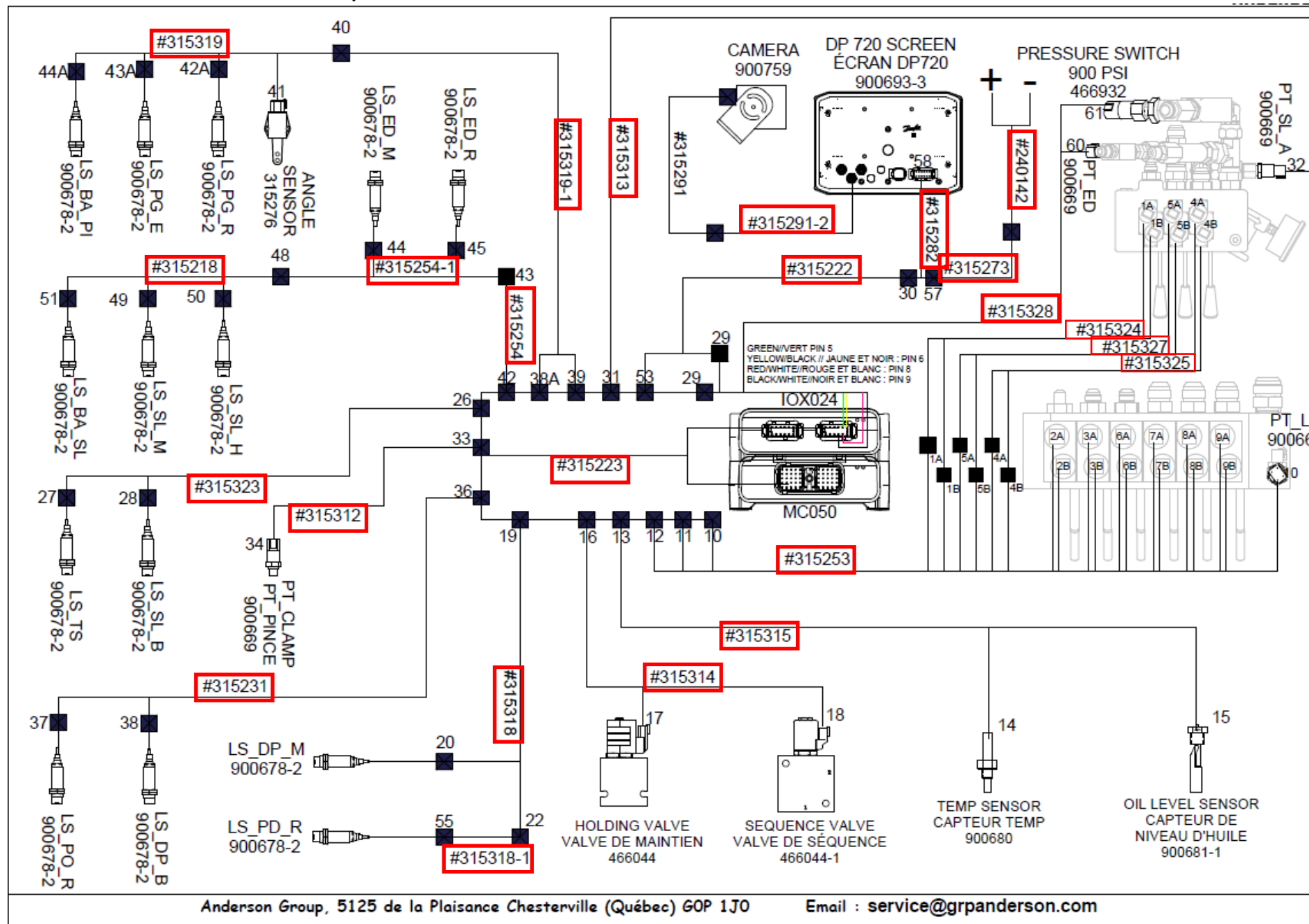

240142

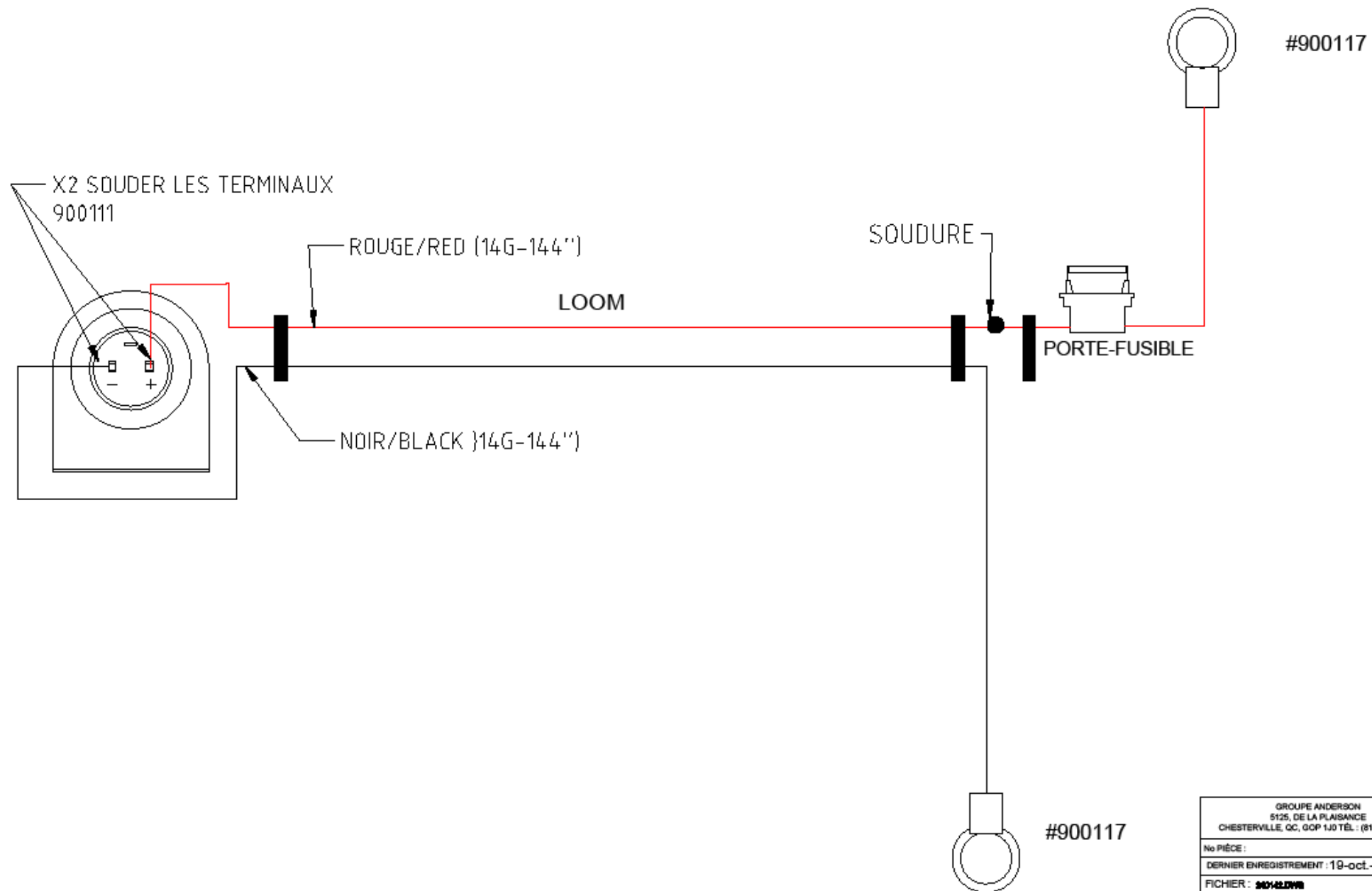

GRUPE ANDERSON 5125, DE LA PLAISANCE CHESTERVILLE, QC, G0P 1J0 TEL : (819) 382-2052
No PIÈCE :
DERNIER ENREGISTREMENT : 10-oct-23
FICHER : 240142.DWG

315218

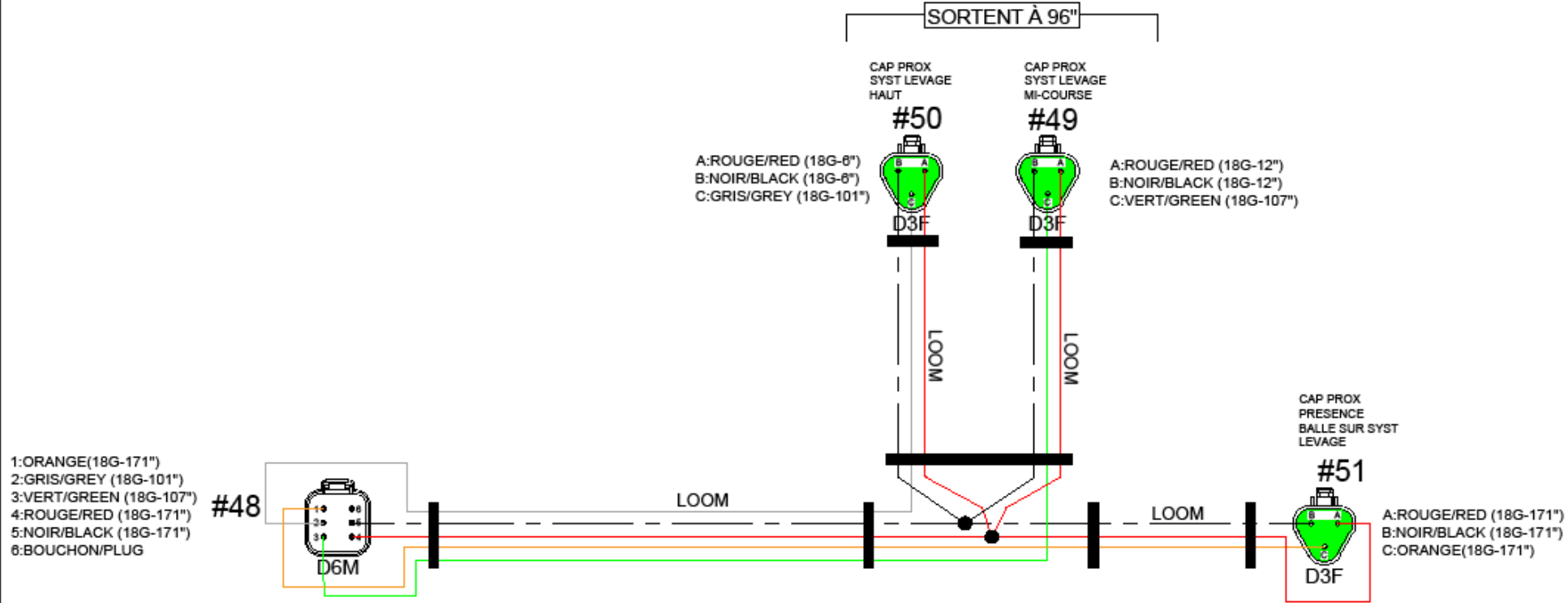

GROUPE ANDERSON  
 5125, DE LA PLAISANCE  
 CHESTERVILLE, QC, G0P 1J0 TÉL. : (514) 382-2952  
 No PIÈCE :  
 DERNIER ENREGISTREMENT : 25-janv.-23  
 FICHER : **315218.DWG**

315222

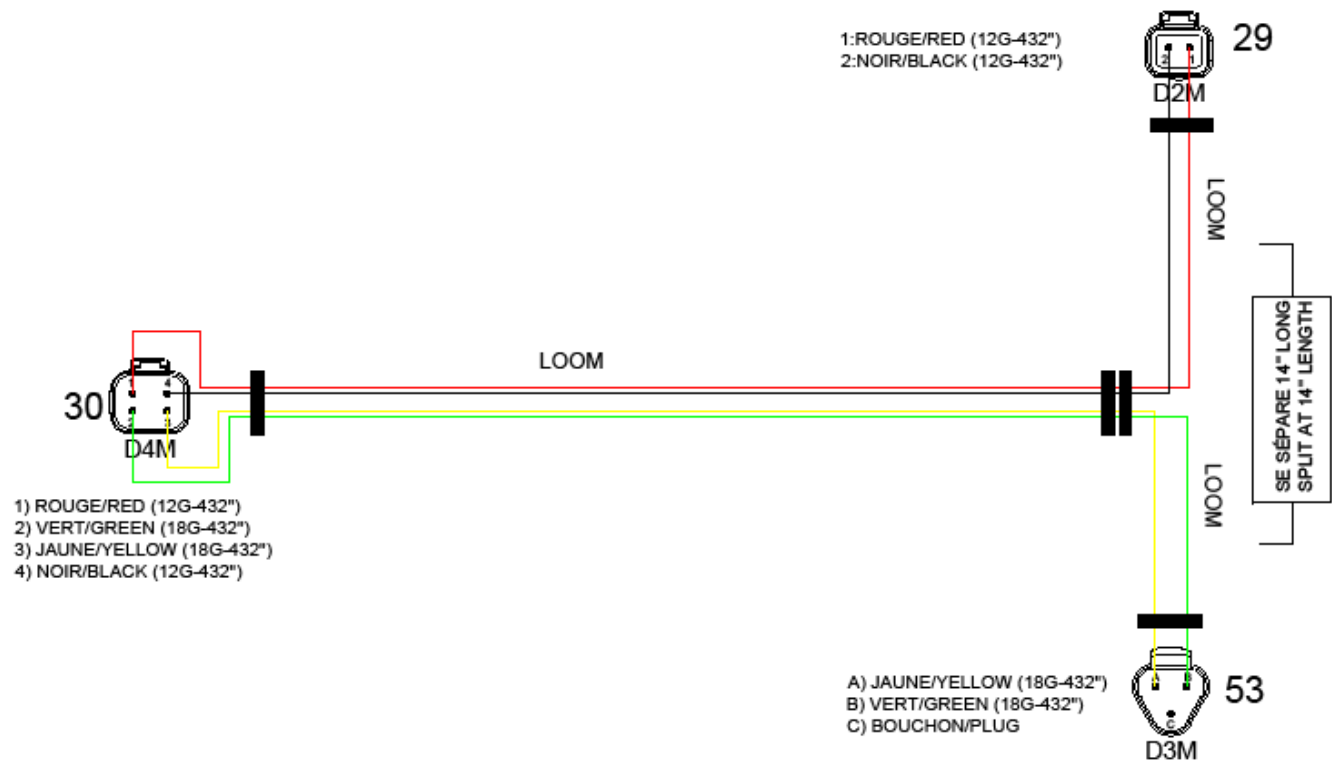

GRUPE ANDERSON 5125, DE LA PLAISANCE CHESTERVILLE, QC, G0P 1J0 TÉL : (514) 382-2952
No PIÈCE :
DERNIER ENREGISTREMENT : 17-mars-23
FICHER : 315222.FRM

315223



- 29) JAUNE-NOIR (18G-12")  
YELLOW-BLACK
- 35) BLANC/WHITE (18G-12")
- 36) BLANC-NOIR (18G-12")  
WHITE-BLACK
- 37) GRIS/GREY (18G-12")
- 38) GRIS-BLANC (18G-12")  
GREY-WHITE
- 39) MAUVE/PURPLE (18G-12")
- 40) MAUVE-BLANC (18G-12")  
PURPLE-WHITE
- 41) BLEU/BLUE (18G-12")
- 42) BLEU-BLANC (18G-12")  
BLUE-WHITE
- 43) ROSE-PINK (18G-12")
- 44) ROSE-BLANC (18G-12")  
PINK-WHITE
- 45) JAUNE/YELLOW (18G-12")
- 46) JAUNE-BLANC (18G-12")  
YELLOW-WHITE

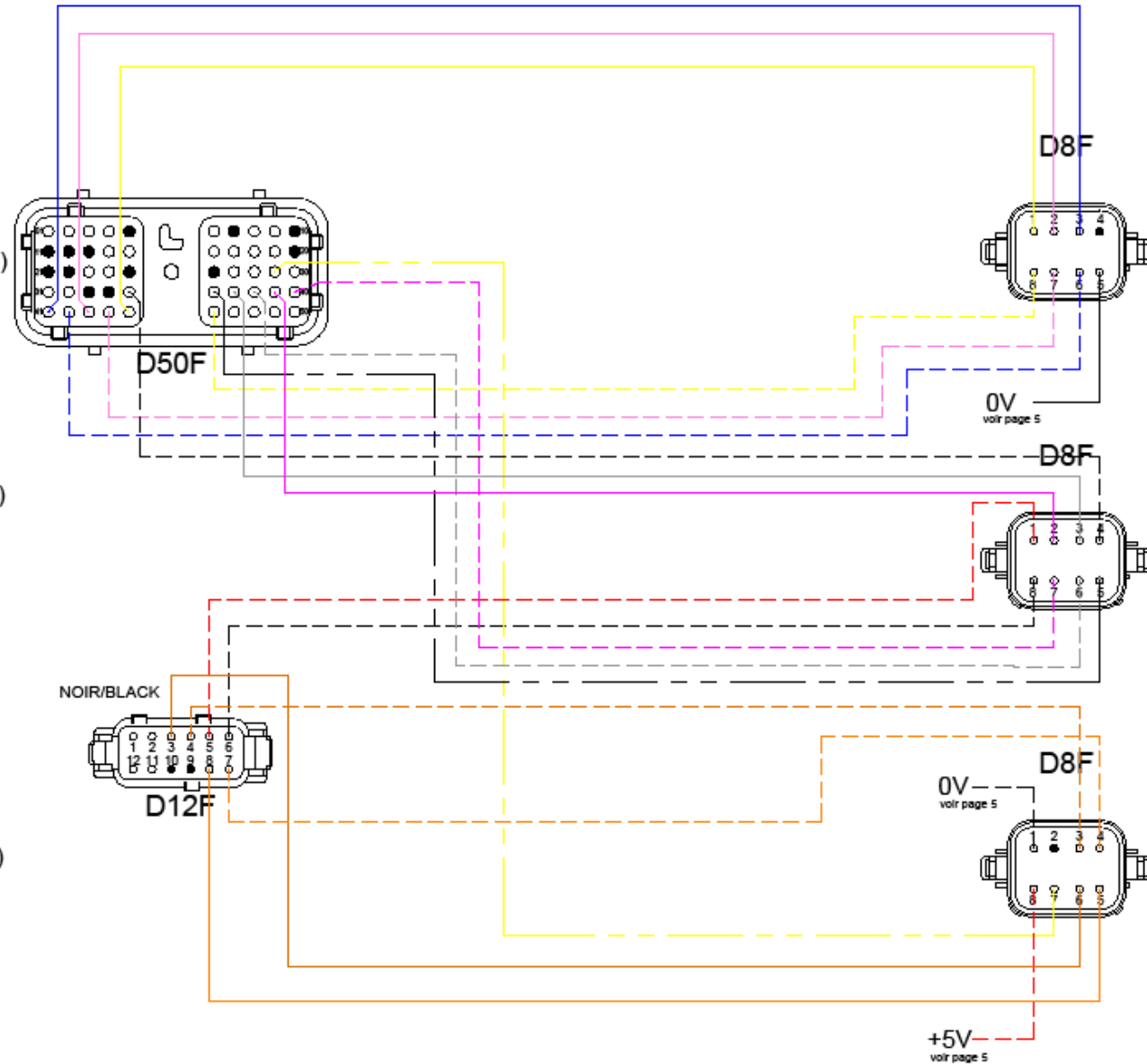

- 3) BRUN/BROWN (18G-12")
- 4) BRUN-BLANC (18G-12")  
BROWN-WHITE
- 5) ROUGE-BLANC (18G-12")  
RED-WHITE
- 6) NOIR-BLANC (18G-12")  
BLACK-WHITE
- 7) ORANGE-BLANC(18G-12")  
ORANGE-WHITE
- 8) ORANGE (18G-12")

- 1) JAUNE (12")
- 2) ROSE (12")
- 3) BLEU (12")
- 4) BOUCHON
- 5) NOIR (4")
- 6) BLEU-BLANC (12")
- 7) ROSE-BLANC (12")
- 8) JAUNE-BLANC (12")

#10

- 1) ROUGE-BLANC (12")
- 2) MAUVE (12")
- 3) GRIS (12")
- 4) BLANC (12")
- 5) BLANC-NOIR (12")
- 6) GRIS-BLANC (12")
- 7) MAUVE-BLANC (12")
- 8) NOIR-BLANC (12")

#11

- 1) NOIR-BLANC (6")
- 2) BOUCHON
- 3) BRUN-BLANC (12")
- 4) ORANGE-BLANC(12")
- 5) ORANGE (12")
- 6) BRUN (12")
- 7) JAUNE-NOIR (12")
- 8) ROUGE-BLANC (6")

#12

GROUPE ANDERSON 5125, DE LA PLAISANCE CHESTERVILLE, QC, G0P 1J0 TEL : (514) 382-2952
No PIÈCE :
DERNIER ENREGISTREMENT : 1-déc.-20
FICHER :



- MAINTIEN SEQUENCE**
- A) JAUNE-BLANC/ (18G-12")  
YELLOW-WHITE
  - B) NOIR/BLACK (18G-6")
  - C) VERT/GREEN (18G-12")

- TEMP**
- 1) NOIR-BLANC/ (18G-6")  
BLACK-WHITE
  - 2) ORANGE-BLANC (18G-12")  
ORANGE-WHITE
  - 3) VERT/GREEN (18G-12")
  - 4) ROUGE/RED (18G-6")

- PT-PINCE**
- 1) NOIR-BLANC/BLACK-WHITE (18G-12")
  - 2) ROUGE-BLANC/RED-WHITE (18G-12")
  - 3) BOUCHON/PLUG
  - 4) BRUN/BROWN (18G-12")

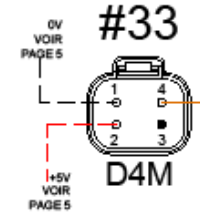
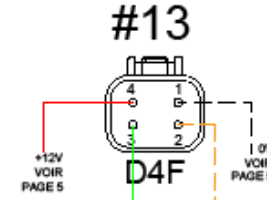
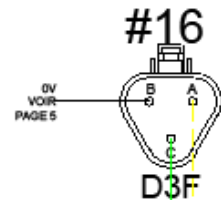

- 06) VERT/GREEN (18G-12")
- 14) MAUVE/PURPLE (18G-12")
- 15) ROSE/PINK (18G-12")
- 16) JAUNE-NOIR/(18G-12")  
YELLOW-BLACK
- 19) GRIS/GREY (18G-12")
- 24) BLEU/BLUE (18G-12")
- 27) ORANGE-BLANC/(18G-12")  
ORANGE-WHITE
- 28) BRUN/BROWN (18G-12")
- 30) ORANGE/ORANGE (18G-12")
- 31) VERT/GREEN (18G-12")
- 32) JAUNE-BLANC/ (18G-12")  
YELLOW-WHITE

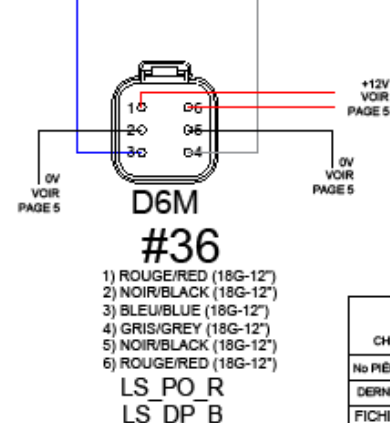
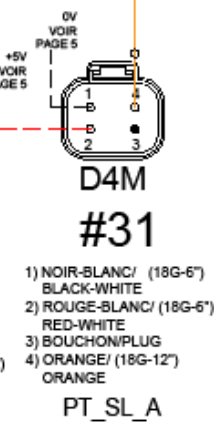
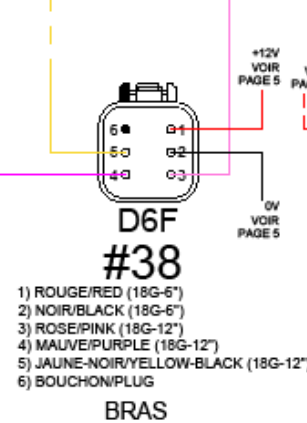
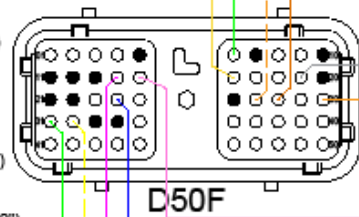

GROUPE ANDERSON 5125, DE LA PLAISANCE CHESTERVILLE, QC, G0P 1J0 TEL : (514) 382-2952	
No PIÈCE :	
DERNIER ENREGISTREMENT : 1-déc.-20	
FICHER : 315223.DWG	

**NOIR/BLACK**

- 1) JAUNE/YELLOW (18G-12")
- 2) BLEU-BLANC/(18G-12")  
BLUE-WHITE

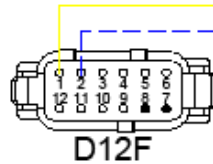

- 17) ORANGE/ORANGE (18G-12")
- 18) BLANC/WHITE (18G-12")
- 23) MAUVE/PURPLE (18G-12")

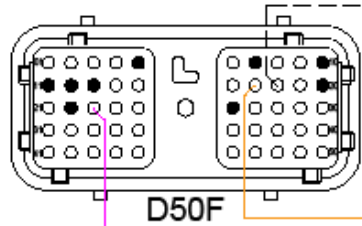

**GRIS/GREY**

- 12) GRIS/GREY (18G-12")
- 11) VERT/GREEN (18G-12")
- 10) BRUN/BROWN (18G-12")
- 7) BLEU/BLUE (18G-12")

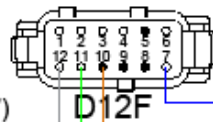

**#26**

- 1) ROUGE/RED (18G-6")
- 2) NOIR/BLACK (18G-6")
- 3) BLANC/WHITE (18G-12")
- 4) JAUNE/YELLOW (18G-12")

LS\_TS  
LS\_SL\_B

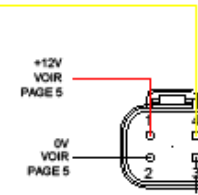

D4M

- 1) ORANGE/ORANGE (18G-6")
- 2) GRIS/GREY (18G-6")
- 3) BRUN/BROWN (18G-12")
- 4) BLEU/BLUE (18G-12")
- 5) ROUGE/RED (18G-3")
- 6) NOIR/BLACK (18G-3")
- 7) VERT/GREEN (18G-6")
- 8) BOUCHON/PLUG

**#42**

LS\_ED\_M  
LS\_ED\_R  
LS\_SL\_M  
LS\_SL\_H  
LS\_BA\_SL

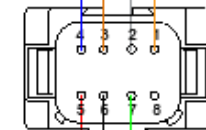

+12V VOIR PAGE 5  
0V VOIR PAGE 5

**#19**

- 1) ROUGE/RED (18G-6")
- 2) NOIR/BLACK (18G-6")
- 3) MAUVE/PURPLE (18G-12")
- 4) BLEU-BLANC/BLUE-WHITE (18G-12")
- 5) BOUCHON/PLUG
- 6) BOUCHON/PLUG

LS\_DP\_M  
LS\_PO\_R

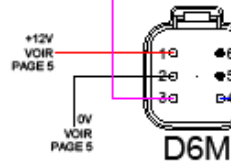



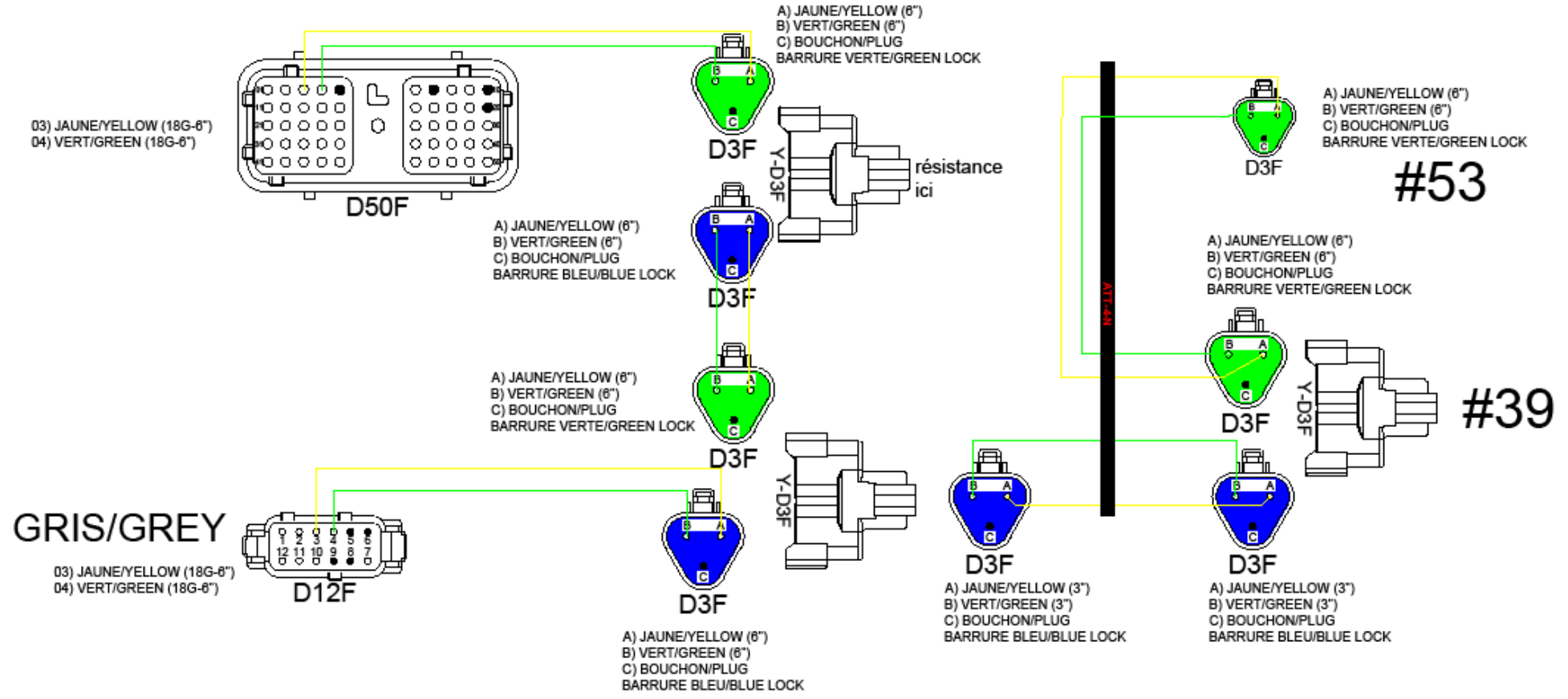

315223

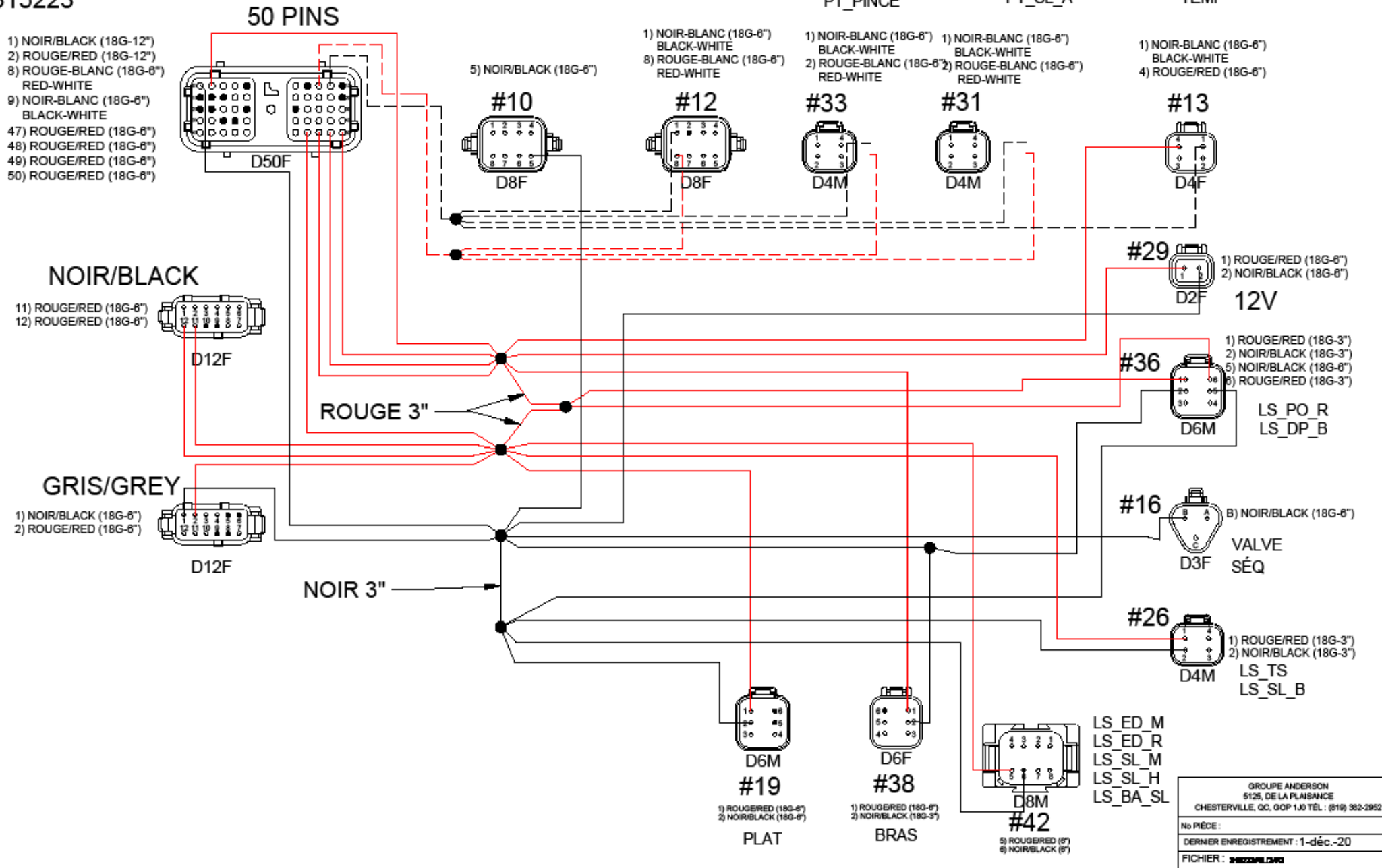

315231



- 1:ROUGE/RED (18G-28")
- 2:NOIR/BLACK (18G-28")
- 3:BLEU/BLEU (18G-28")
- 4:GRIS/GREY (18G-28")
- 5:NOIR/BLACK (18G-28")
- 6:ROUGE/RED (18G-28")

#36

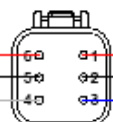

D6F  
315231

LOOM

LOOM

CAP PROX  
POUSOIR  
RETRACT

#37

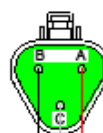

D3F

- A:ROUGE/RED (18G-28")
- B:NOIR/BLACK (18G-28")
- C:GRIS/GREY (18G-28")

D3F

#38

CAP PROX  
DOMPEUR BAS

- A:ROUGE/RED (18G-28")
- B:NOIR/BLACK (18G-28")
- C:BLEU/BLEU (18G-28")

GROUPE ANDERSON 5125, DE LA PLAISANCE CHESTERVILLE, QC, QOP 1J0 TEL : (514) 382-2952
No PIÈCE :
DERNIER ENREGISTREMENT : 25-janv.-23
FICHER : 315231.DWG

315253

- 1A** 1) ROUGE-BLANC (18G-26")  
RED-WHITE  
2) NOIR/BLACK (18G-6 1/2")
- 1B** 1) NOIR-BLANC (18G-26")  
BLACK-WHITE  
2) NOIR/BLACK (18G-6 1/2")

- 3A** 1) JAUNE/YELLOW (18G-30")  
2) NOIR/BLACK (18G-6 1/2")
- 3B** 1) JAUNE-BLANC (18G-30")  
YELLOW-WHITE  
2) NOIR/BLACK (18G-6 1/2")

- 5A** 1) ORANGE (18G-34")  
2) NOIR/BLACK (18G-6 1/2")
- 5B** 1) ORANGE-BLANC (18G-34")  
ORANGE-WHITE  
2) NOIR/BLACK (18G-6 1/2")

- 6A** 1) BLEU/BLUE (18G-36")  
2) NOIR/BLACK (18G-6 1/2")
- 6B** 1) BLEU-BLANC (18G-36")  
BLUE-WHITE  
2) NOIR/BLACK (18G-6 1/2")

- 8A** 1) GRIS/GREY (18G-40")  
2) NOIR/BLACK (18G-6 1/2")
- 8B** 1) GRIS-BLANC (18G-40")  
GREY-WHITE  
2) NOIR/BLACK (18G-6 1/2")

- 1) NOIR-BLANC (18G-46")  
BLACK-WHITE  
2) ROUGE-BLANC (18G-46")  
RED-WHITE  
3) BOUCHON/PLUG  
4) JAUNE-NOIR (18G-46")  
YELLOW-BLACK

SORTENT À 20"

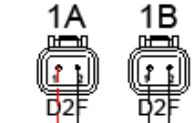

SORTENT À 24"

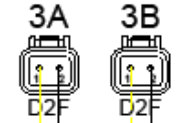

SORTENT À 28"

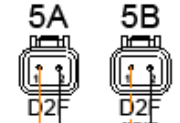

SORTENT À 30"

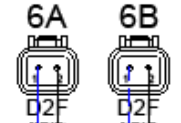

SORTENT À 34"

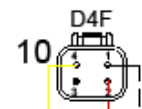
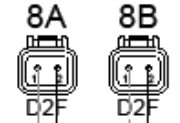

LOOM(16 X)

- 2A** 1) BRUN/BROWN (18G-28")  
2) NOIR/BLACK (18G-6 1/2")
- 2B** 1) BRUN-BLANC (18G-28")  
BROWN-WHITE  
2) NOIR/BLACK (18G-6 1/2")

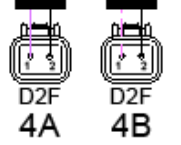
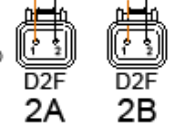

- 4A** 1) ROSE/PINK (18G-32")  
2) NOIR/BLACK (18G-6 1/2")
- 4B** 1) ROSE-BLANC (18-32")  
2) NOIR/BLACK (18G-6 1/2")

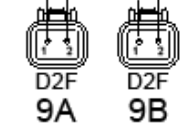
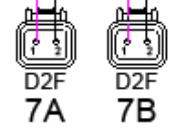

SORTENT À 22"

SORTENT À 26"

SORTENT À 32"

SORTENT À 36"

LOOM

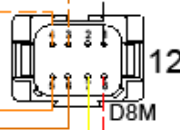
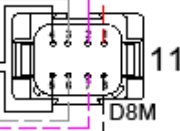
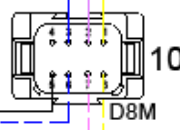

- 1) JAUNE/YELLOW (18G-30")  
2) ROSE/PINK (18G-32")  
3) BLEU/BLUE (18G-36")  
4) BOUCHON/PLUG  
5) NOIR/BLACK (18G-42")  
6) BLEU-BLANC/BLUE-WHITE (18G-36")  
7) ROSE-BLANC/PINK-WHITE (18G-32")  
8) JAUNE-BLANC/YELLOW-WHITE (18G-30")

- 1) ROUGE-BLANC/RED-WHITE (18G-26")  
2) MAUVE/PURPLE (18G-38")  
3) GRIS/GREY (18G-40")  
4) BLANC/WHITE (18G-42")  
5) BLANC-NOIR/WHITE-BLACK (18G-42")  
6) GRIS-BLANC/GREY-WHITE (18G-40")  
7) MAUVE-BLANC/PURPLE-WHITE (18G-38")  
8) NOIR-BLANC/BLACK-WHITE (18G-26")

- 1) NOIR-BLANC/BLACK/WHITE (18G-46")  
2) BOUCHON/PLUG  
3) BRUN-BLANC/BROWN-WHITE (18G-28")  
4) ORANGE-BLANC/ORANGE-WHITE (18G-34")  
5) ORANGE (18G-34")  
6) BRUN/BROWN (18G-28")  
7) JAUNE-NOIR/YELLOW-BLACK (18G-46")  
8) ROUGE-BLANC/RED-WHITE (18G-46")

- 7A** 1) MAUVE/PURPLE (18G-38")  
2) NOIR/BLACK (18G-6 1/2")
- 7B** 1) MAUVE-BLANC (18G-38")  
PURPLE-WHITE  
2) NOIR/BLACK (18G-6 1/2")

- 9A** 1) BLANC/WHITE (18G-42")  
2) NOIR/BLACK (18G-42")
- 9B** 1) BLANC-NOIR (18G-42")  
WHITE-BLACK  
2) NOIR/BLACK (18G-42")

GRUPE ANDERSON  
5125, DE LA PLAISANCE  
CHESTERVILLE, QC, G0P 1J0 TEL : (819) 382-2952

No PIÈCE:  
DERNIER ENREGISTREMENT : 21-sept-22  
FICHER : 31 0253.DWG



315254

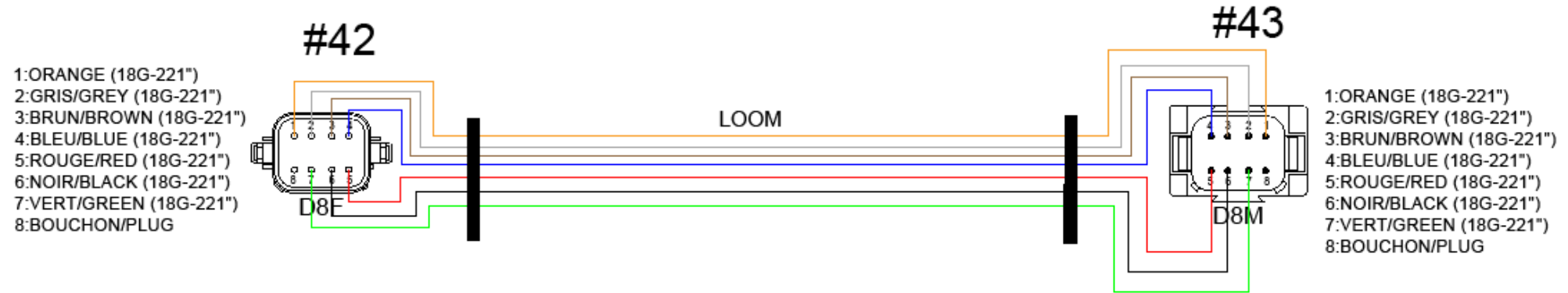

GRUPE ANDERSON 5125, DE LA PLAISANCE CHESTERVILLE, QC, G0P 1J0 TEL : (514) 382-2952
No PIÈCE :
DERNIER ENREGISTREMENT : 4-juin-20
FICHIER : 315254.DWG

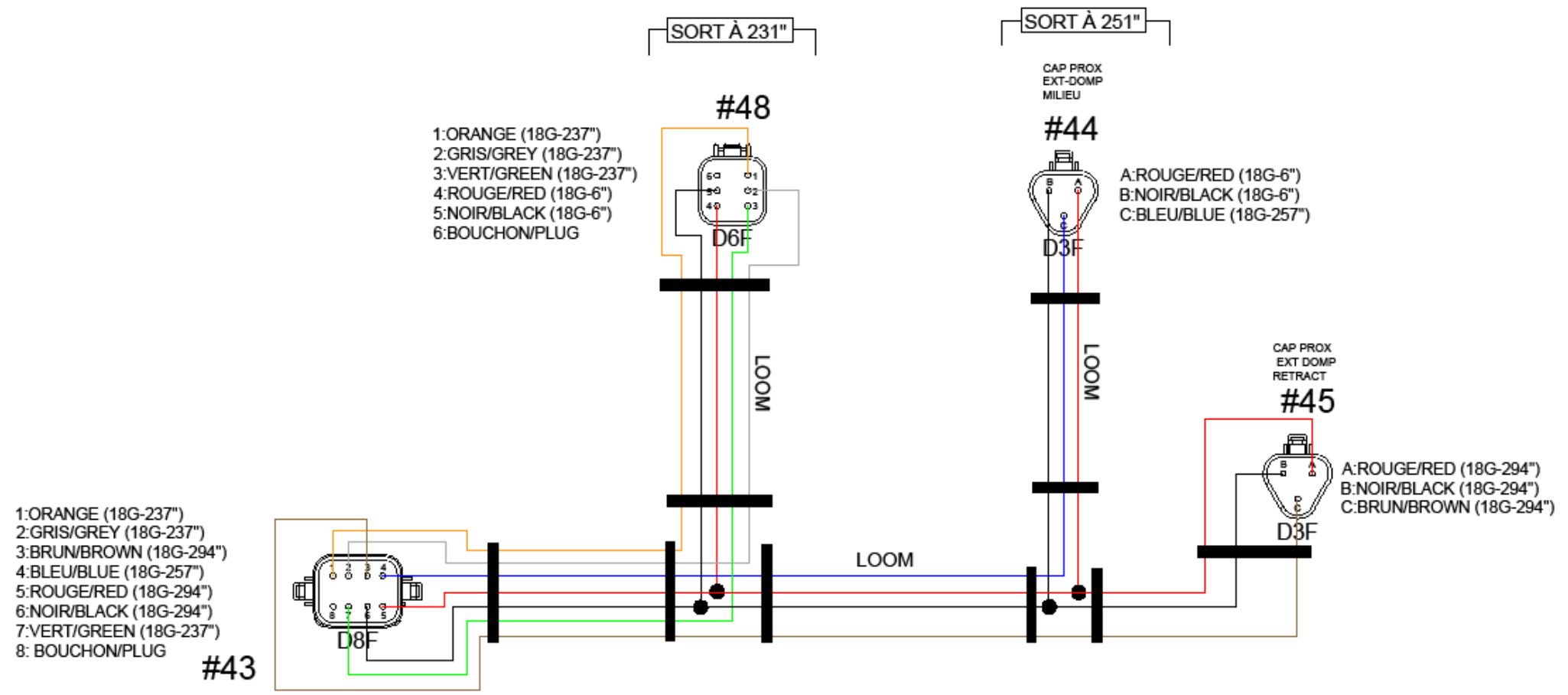

GROUPE ANDERSON 5125, DE LA PLAISANCE CHESTERVILLE, QC, G0P 1J0 TÉL : (514) 382-2952
No PIÈCE :
DERNIER ENREGISTREMENT : 1-déc.-20
FICHER : 315254-1.MWD

315273



PRISE  
COBO  
AVEC PIN  
MALE

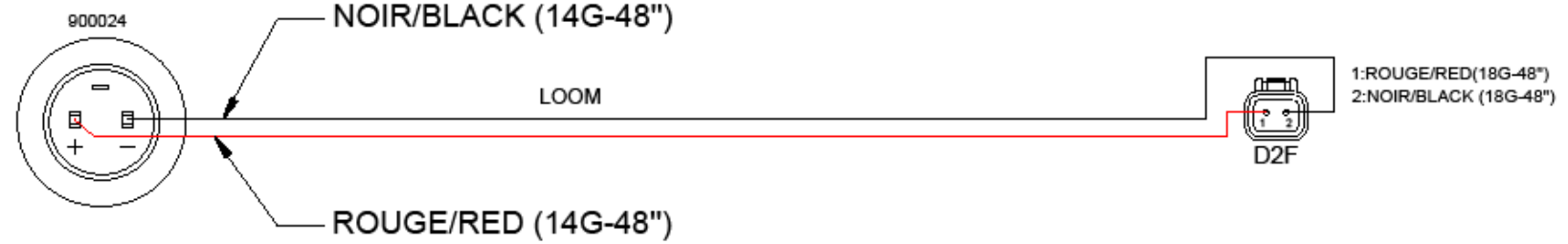

GRUPE ANDERSON 5125, DE LA PLAISANCE CHESTERVILLE, QC, G0P 1J0 TEL : (514) 382-2952
No PIÈCE :
DERNIER ENREGISTREMENT : 31-mars-21
FICHER : 31 0273 0102

315282

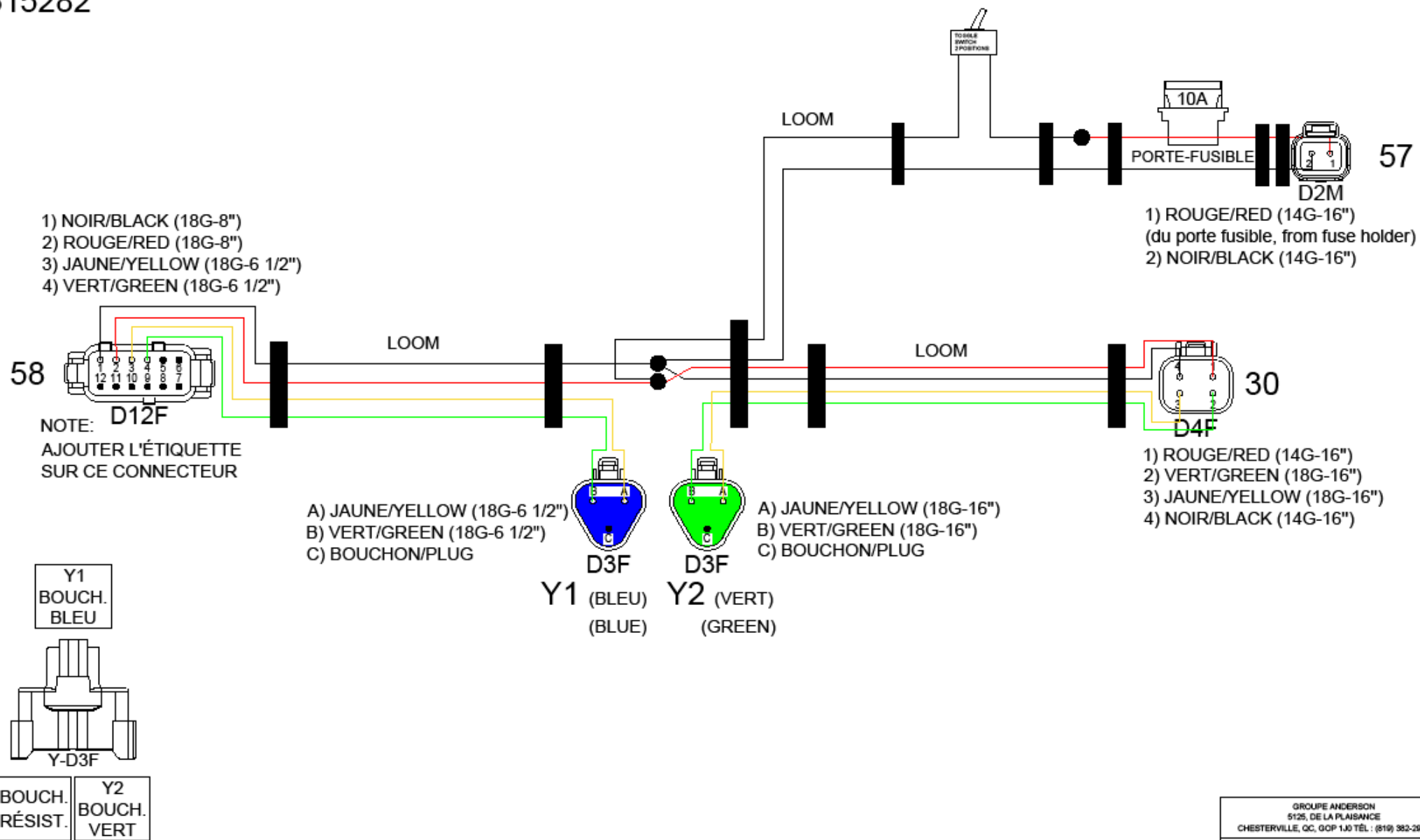

GRUPE ANDERSON  
 5125, DE LA PLAISANCE  
 CHESTERVILLE, QC, G0P 1J0 TÉL : (514) 382-2952

No PIÈCE:  
 DERNIER ENREGISTREMENT : 25-janv.-23  
 FICHER : 315282.DWG



315291-2



\*\*\* LONGUEUR TOTALE DU FIL = 28"  
TOTAL WIRE LENGTH

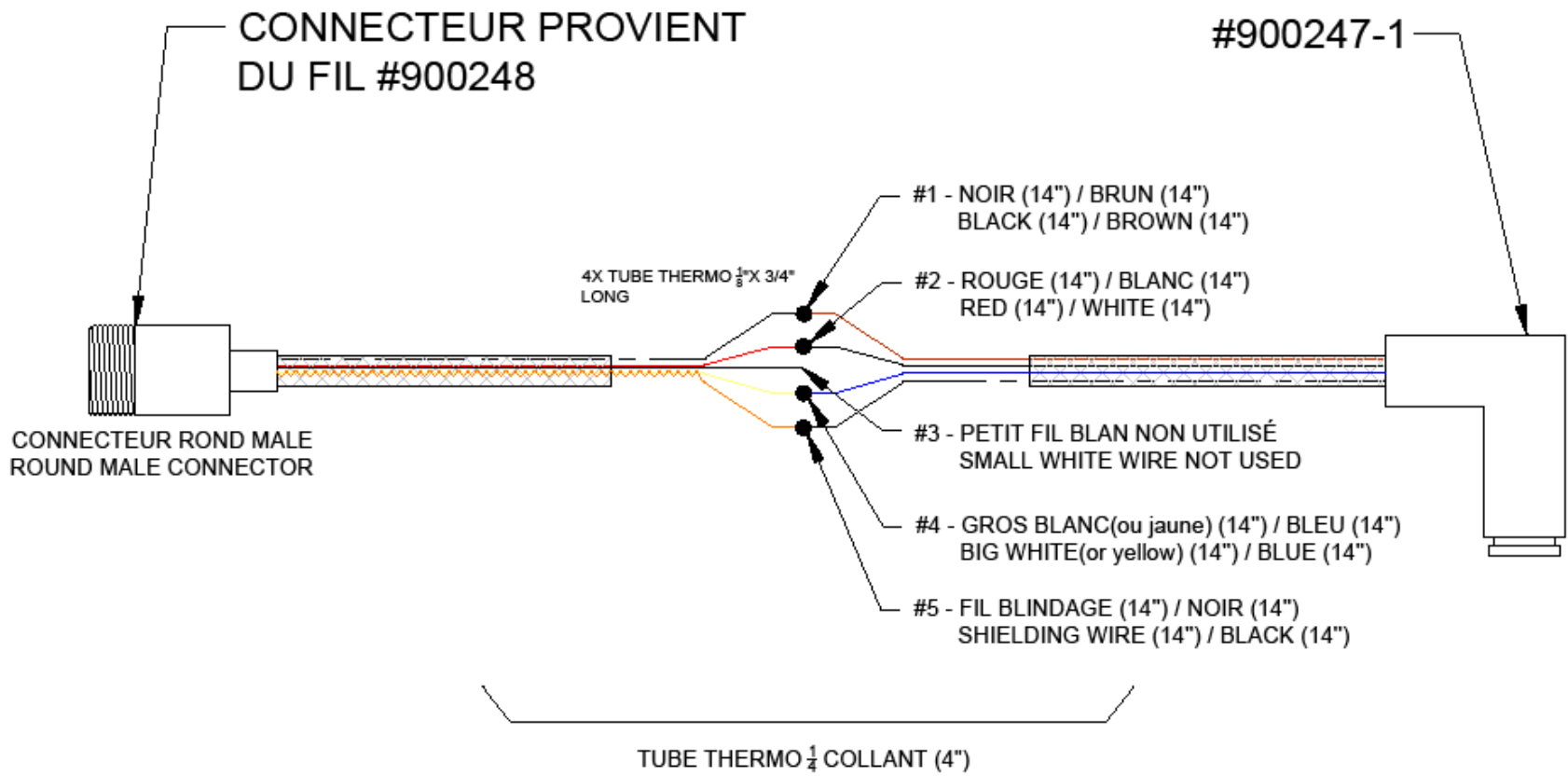

GRUPE ANDERSON 5125, DE LA PLAISANCE CHESTERVILLE, QC, QCP 1J0 TEL : (514) 382-2952
No PIÈCE :
DERNIER ENREGISTREMENT : 25-janv.-23
FICHER : 315291-2.DWG

- 1) NOIR-BLANC (18G-30")  
BLACK-WHITE
- 2) ROUGE-BLANC (18G-30")  
RED-WHITE
- 3) BOUCHON/PLUG
- 4) BRUN/BROWN (18G-30")

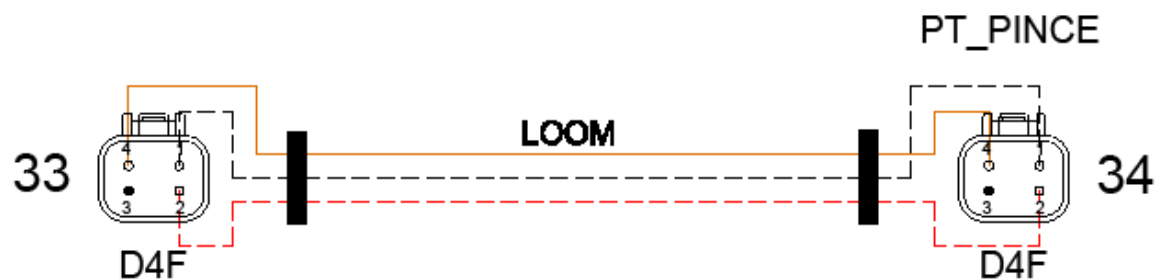

- 1) NOIR-BLANC (18G-30")  
BLACK-WHITE
- 2) ROUGE-BLANC (18G-30")  
RED-WHITE
- 3) BOUCHON/PLUG
- 4) BRUN/BROWN (18G-30")

315313



- 1) NOIR-BLANC (18G-46")  
BLACK-WHITE
- 2) ROUGE-BLANC (18G-46")  
RED-WHITE
- 3) BOUCHON/PLUG
- 4) ORANGE (18G-46")

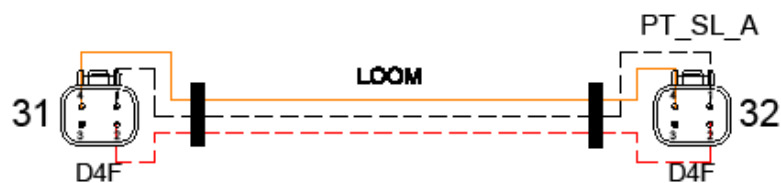

- 1) NOIR-BLANC (18G-46")  
BLACK-WHITE
- 2) ROUGE-BLANC (18G-46")  
RED-WHITE
- 3) BOUCHON/PLUG
- 4) ORANGE (18G-46")

GRUPE ANDERSON 5125, DE LA PLAISANCE CHESTERVILLE, QC, G0P 1J0 T�L : (514) 382-2952
No PI�CE :
DERNIER ENREGISTREMENT : 11-mai-20
FICHER :

315314

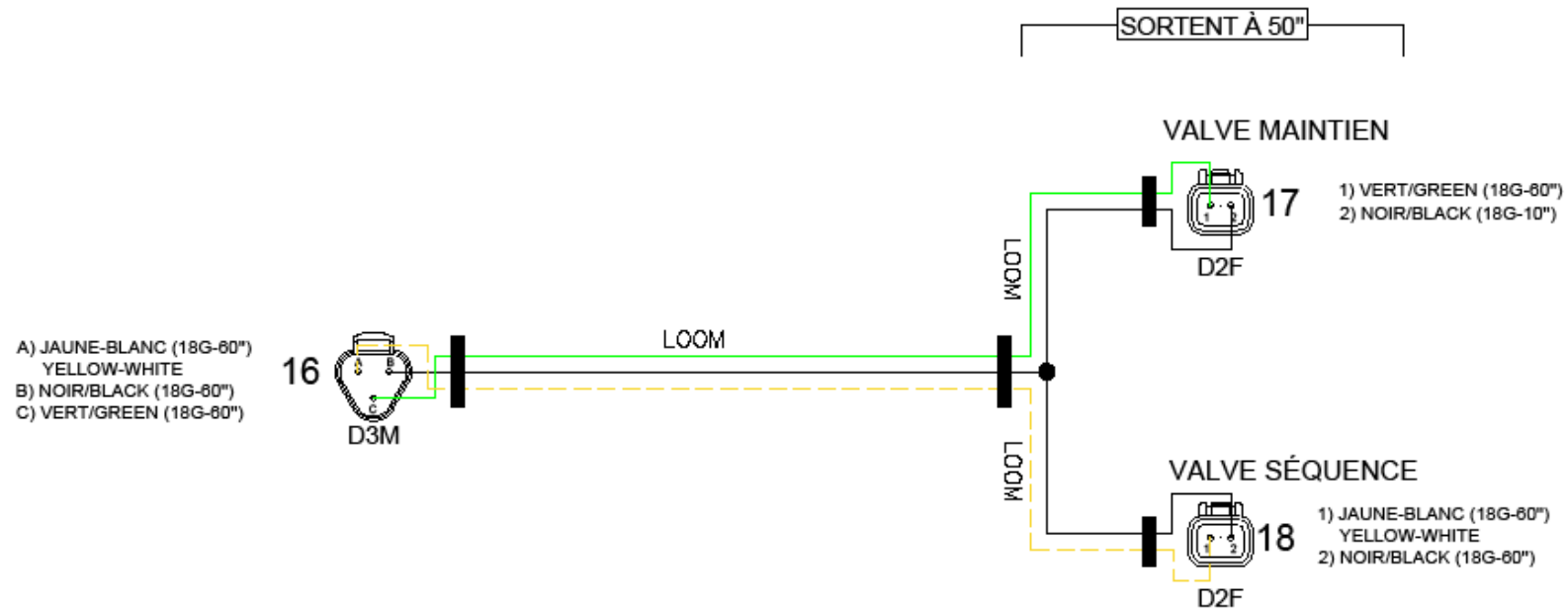

GRUPE ANDERSON 5125, DE LA PLAISANCE CHESTERVILLE, QC, G0P 1J0 TÉL : (514) 382-2952
No PIÈCE :
DERNIER ENREGISTREMENT : 31-mars-21
FICHER : 31 0314.DWG

315315

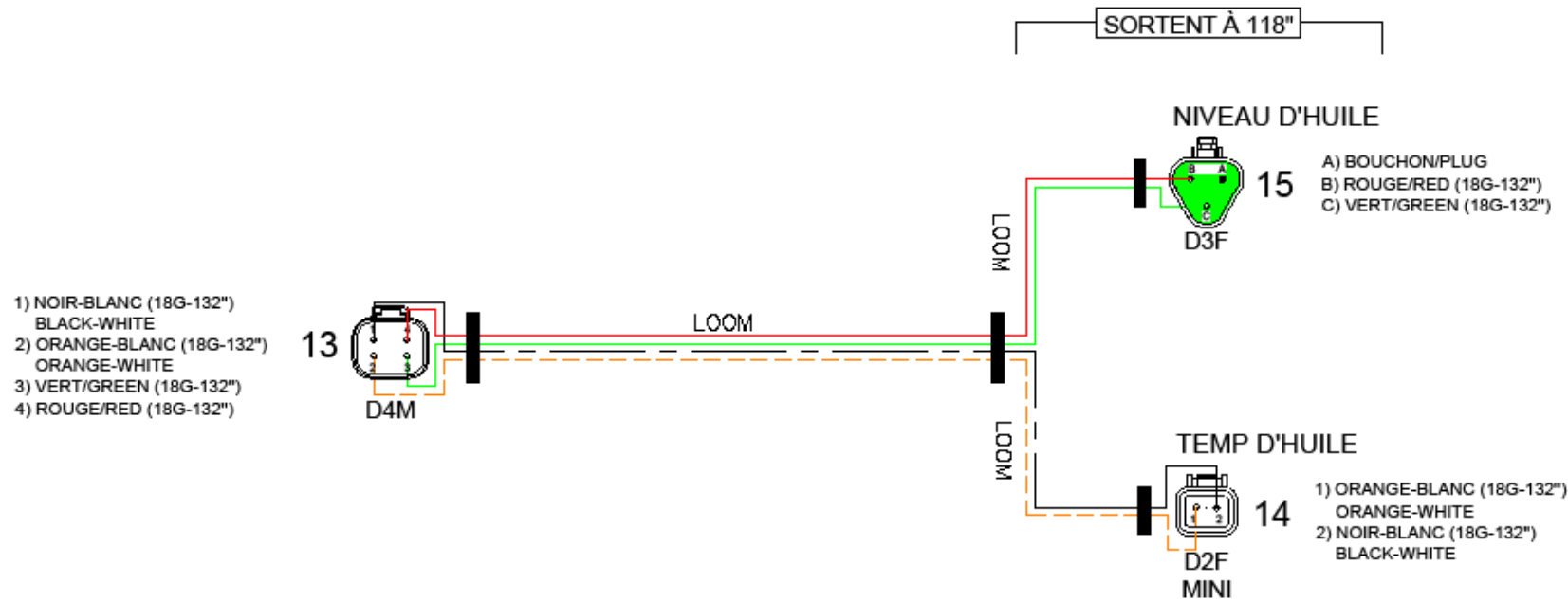

GRUPE ANDERSON 5125, DE LA PLAISANCE CHESTERVILLE, QC, G0P 1J0 TEL : (514) 383-2052
No PIÈCE :
DERNIER ENREGISTREMENT : 29-oct-20
FICHER : 310315.DWG

315318

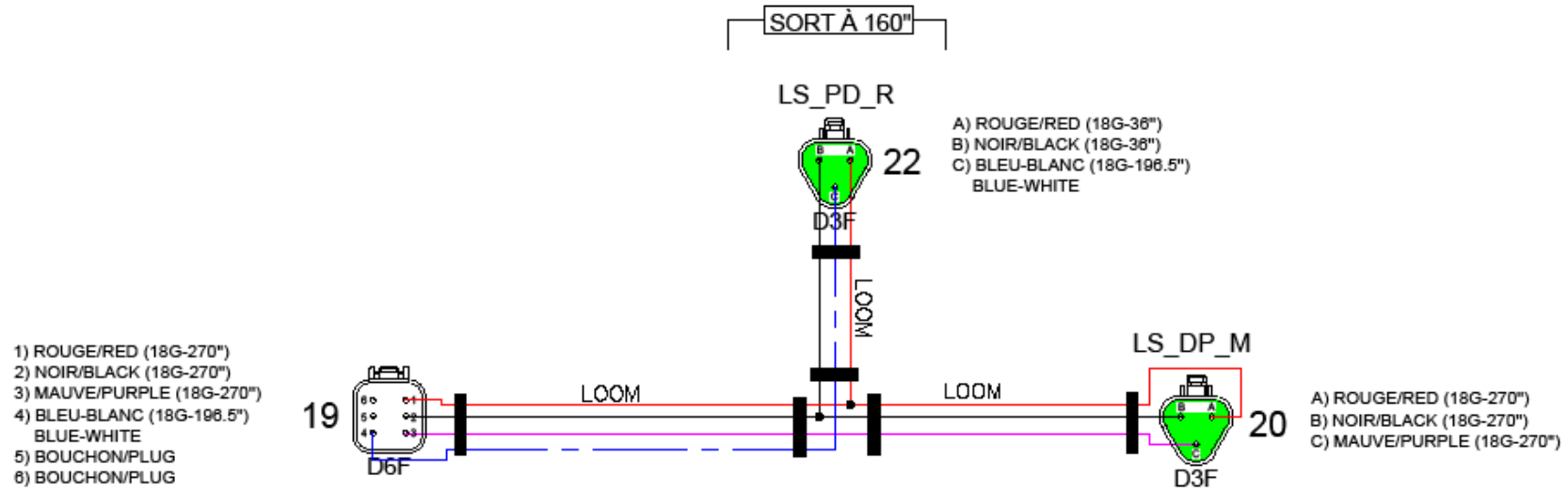

GRUPE ANDERSON 5125, DE LA PLAISANCE CHESTERVILLE, QC, G0P 1J0 TÉL : (514) 382-2952
No PIÈCE :
DERNIER ENREGISTREMENT : 21-sept.-22
FICHER : 3103BLDWC

315318-1

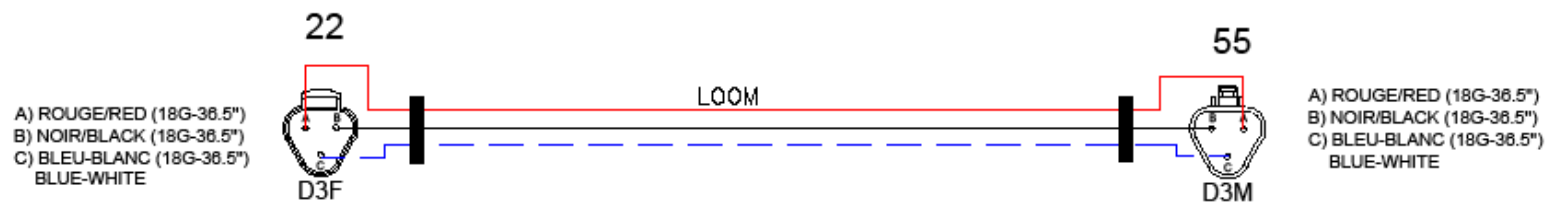

GROUPE ANDERSON 5125, DE LA PLAISANCE CHESTERVILLE, QC, G0P 1J0 TÉL : (514) 382-2952	
No PIÈCE :	
DERNIER ENREGISTREMENT :	21-sept.-22
PICHER - 315318-1.DWG	

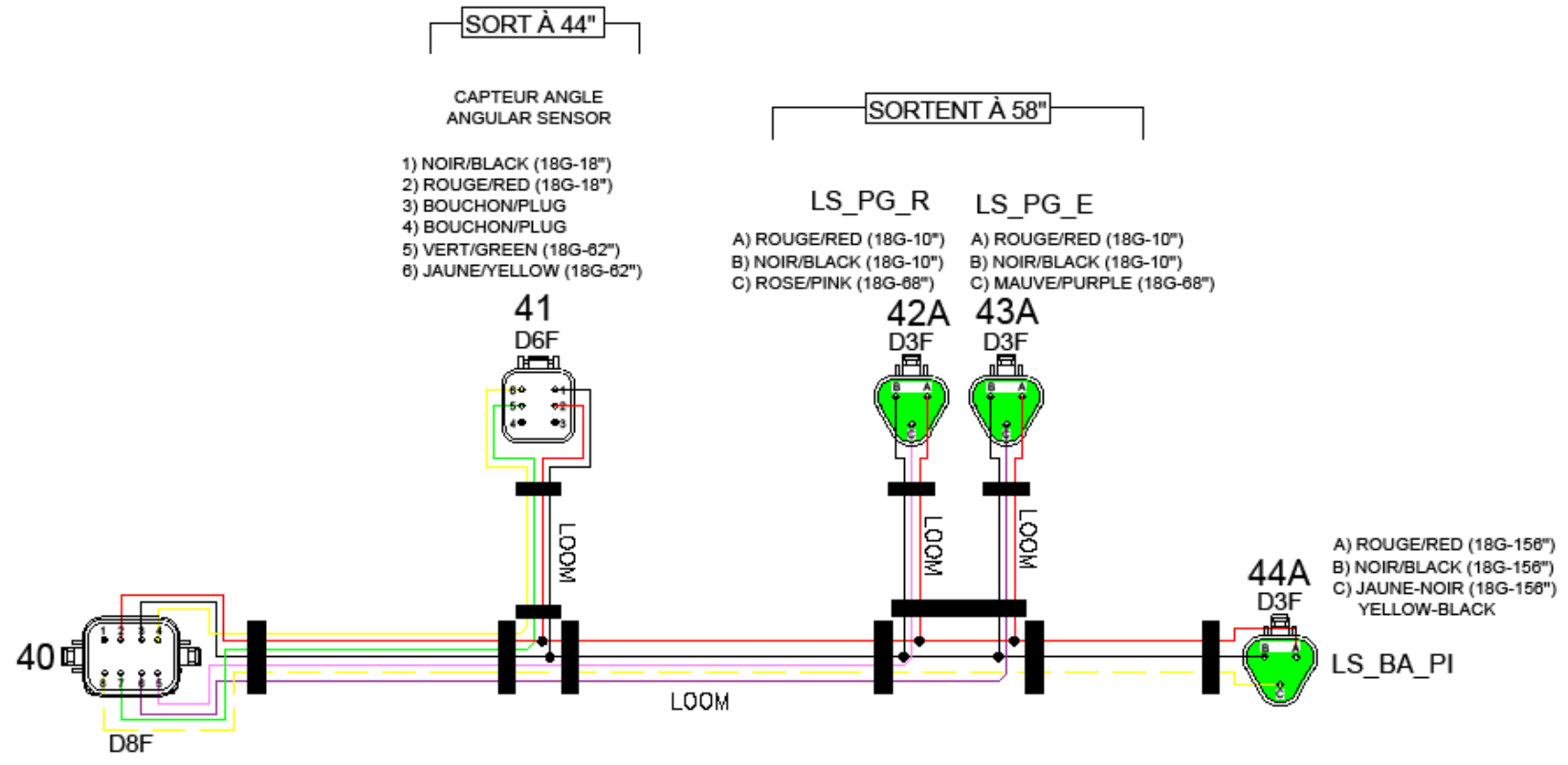



- 1) BOUCHON/PLUG
- 2) ROUGE/RED (18G-110")
- 3) NOIR/BLACK (18G-110")
- 4) JAUNE/YELLOW (18G-110")
- 5) ROSE/PINK (18G-110")
- 6) MAUVE/PURPLE (18G-110")
- 7) VERT/GREEN (18G-110")
- 8) JAUNE-NOIR (18G-110")  
YELLOW-BLACK

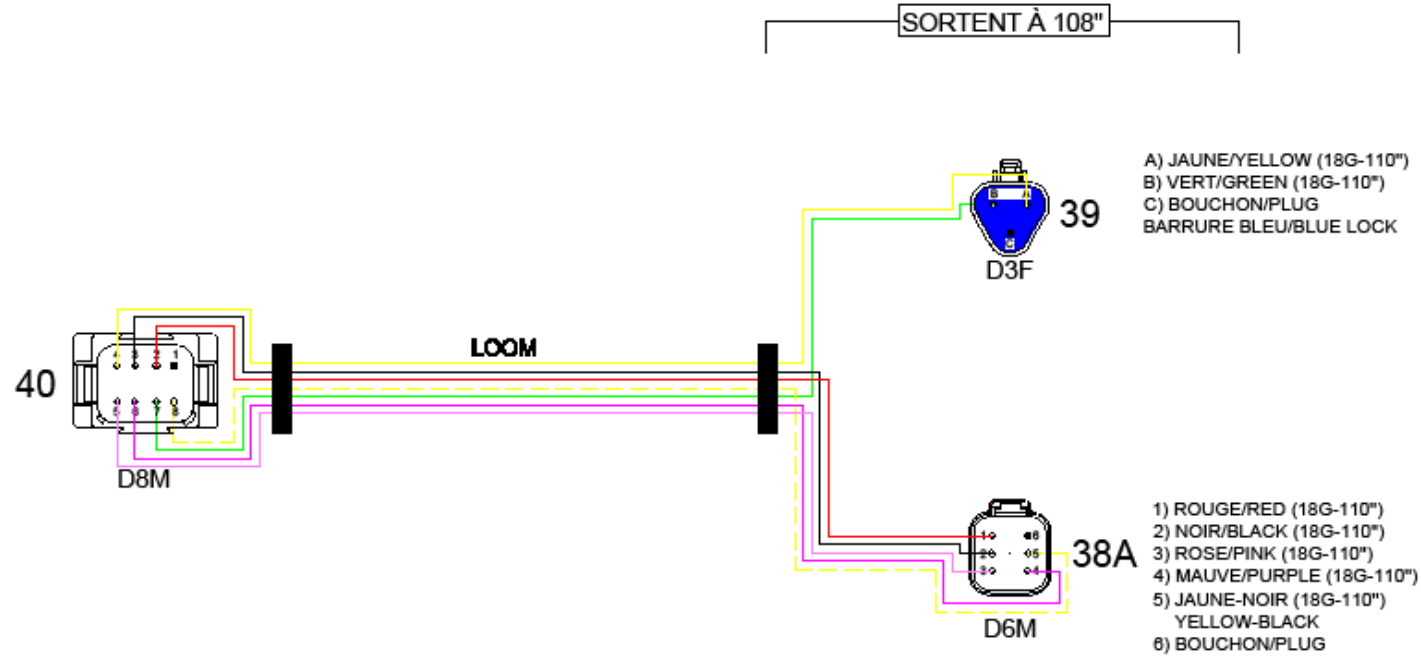

- A) JAUNE/YELLOW (18G-110")
- B) VERT/GREEN (18G-110")
- C) BOUCHON/PLUG  
BARRURE BLEU/BLUE LOCK

- 1) ROUGE/RED (18G-110")
- 2) NOIR/BLACK (18G-110")
- 3) ROSE/PINK (18G-110")
- 4) MAUVE/PURPLE (18G-110")
- 5) JAUNE-NOIR (18G-110")  
YELLOW-BLACK
- 6) BOUCHON/PLUG

315323

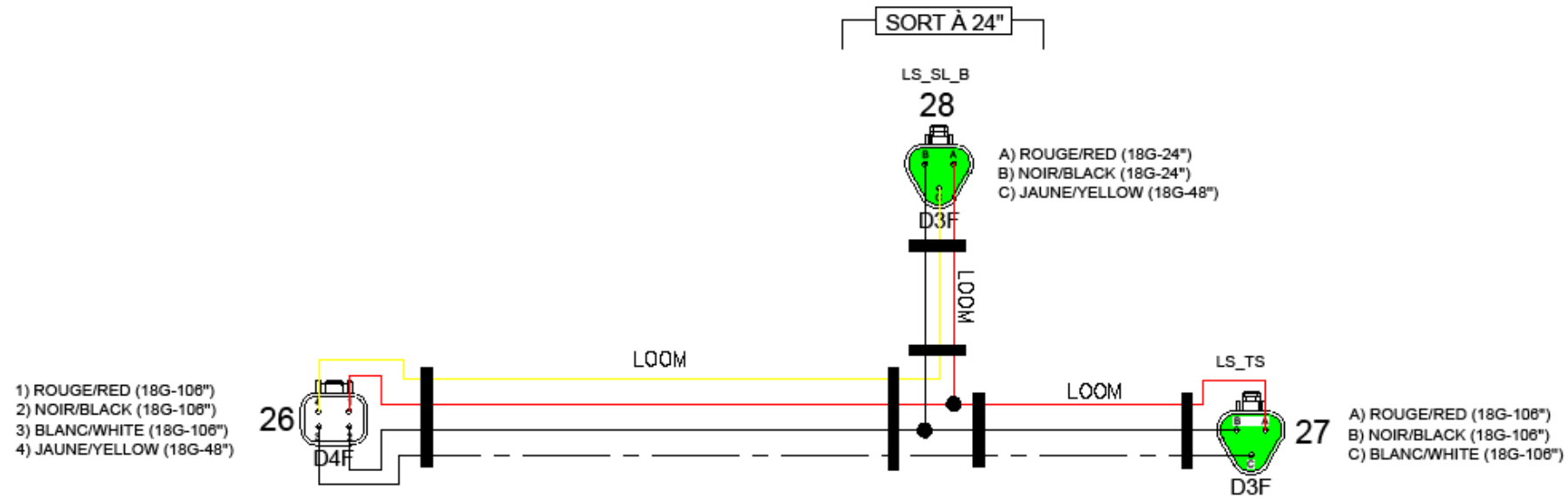

GRUPE ANDERSON 5125, DE LA PLAISANCE CHESTERVILLE, QC, G0P 1J0 TÉL : (514) 382-2052
No PIÈCE :
DERNIER ENREGISTREMENT : 31-mars-21
FICHER : 31 0323.DWG

315324

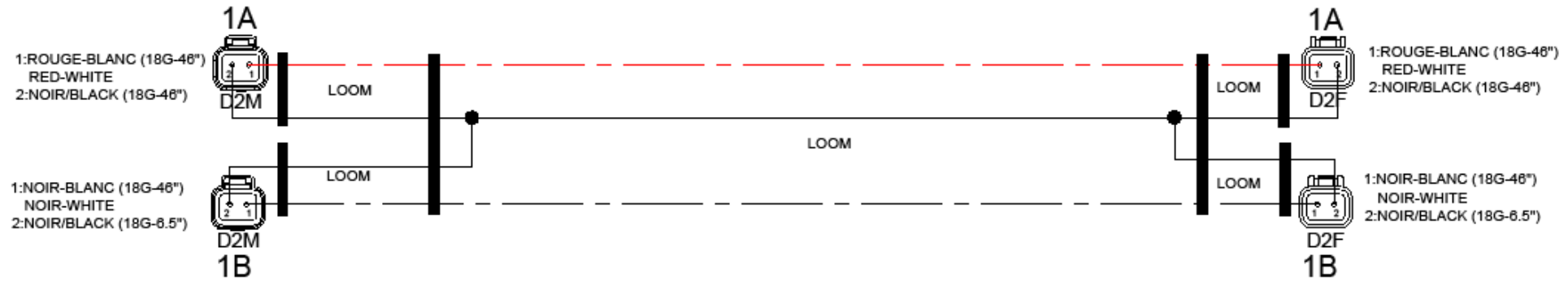

GRUPE ANDERSON 5125, DE LA PLAISANCE CHESTERVILLE, QC, G0P 1J0 TEL : (514) 382-2052
No PIÈCE :
DERNIER ENREGISTREMENT : 31-mars-21
FICHER : 31 0324.DWG

315325

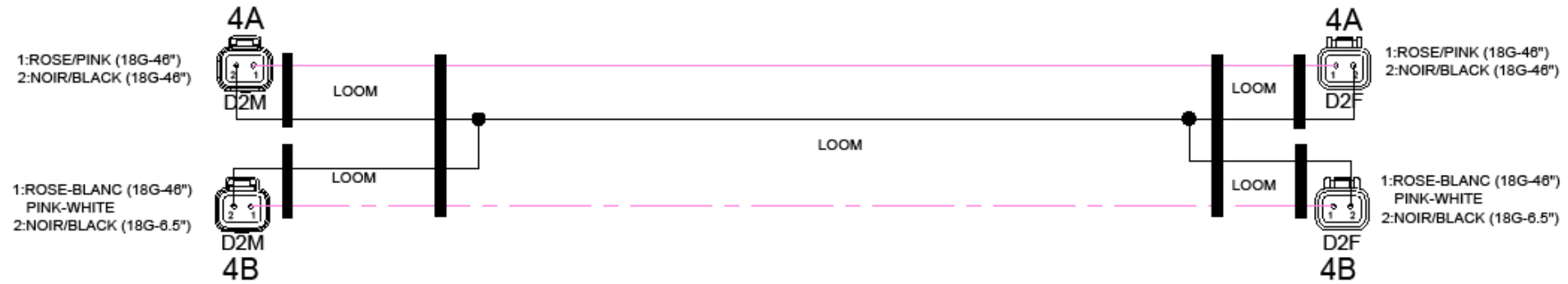

GRUPE ANDERSON 5125, DE LA PLAISANCE CHESTERVILLE, QC, G0P 1J0 TEL : (514) 382-2952
No PIÈCE :
DERNIER ENREGISTREMENT : 31-mars-21
FICHER : 31 0325.DWG

315327

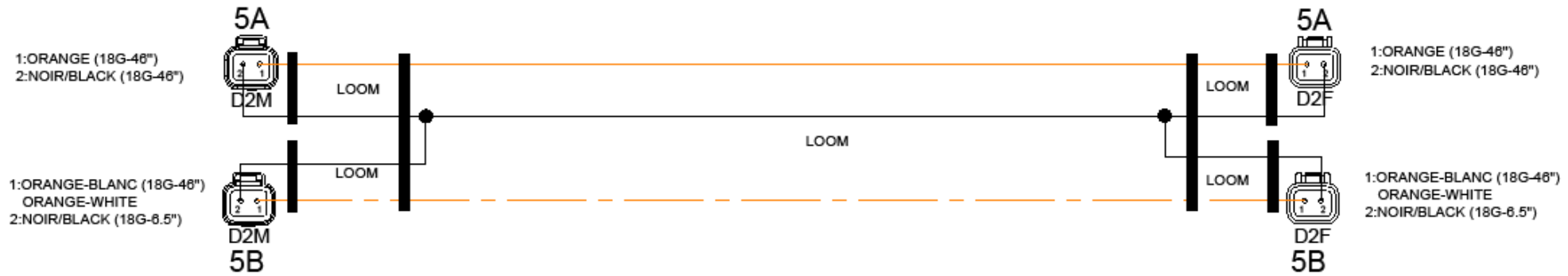

GRUPE ANDERSON 5125, DE LA PLAISANCE CHESTERVILLE, QC, G0P 1J0 TEL : (514) 382-2052
No PIÈCE :
DERNIER ENREGISTREMENT : 21-janv.-21
FICHER : 315327.DWG

315328

4X CONNECTEUR DEUTSCH FEMELLE 18-18G (#900083)  
BRANCHÉS SUR CONNECTEUR GRIS DU MODULE IOX024

